

THEO



PRICELIST



EURO PRICELIST
2025

THEO

designed by
Simon Pengelly

	4	32
	7	36
	9	38
	11	40
	14	43
	18	45
	21	47
	24	49
	26	51
	28	35
	30	55

LIST PRICES IN EURO EXCLUDING VAT

 = READY TO SHIP WITHIN 5 WORKING DAYS, SUBJECT TO STOCK

Theo is a family of furniture products designed for New Design Group by award winning British designer Simon Pengelly. In 2009 Theo began as a design brief to create a wooden stacking chair for use in churches; a market in which New Design Group had already been established for a number of years. The need came from a shift in the way churches are used. They are not just visited on Sundays, but have become places used throughout the week for community activities such as crèches, concerts and cafés. Consequently, the need to quickly clear spaces of heavy and cumbersome pews has become far more of an issue, and given the age of many of those who undertake the job, the need for a light chair that can also be stacked and stored to maximise open space is increasingly relevant. As well as being made wholly from wood, the design brief also required that the chairs link together and stack whilst linked, which presented a challenge in how much a single chair can weigh. The solution was to laminate the chair to achieve small, and therefore light sections that are inherently strong, due to the combination of glue layers and wood veneers. The result is a wooden chair that has passed contract strength testing whilst weighing just 4kg. Due to its light weight, 30 chairs can be comfortably stacked on a purpose-designed trolley whilst linked.

The highly resolved nature of Theo's design has seen it transcend from the ecclesiastical space into a multitude of environments in which it is equally suitable. The growth in popularity of the chair across a range of applications naturally led to the development of a matching family of Theo products. Each item in the Theo range embodies the elegant and purposeful aesthetic of the chair whilst being individually striking designs in their own right.







reddot design award



Simon Pengelly



THEO CHAIR

Reference Code	Description	Weight (kg)	Fabric Qty Linear M	Leather Qty Square M	Natural	Stained	COM	Fabric 1	Fabric 2	Fabric 3	Fabric 4	Fabric 5	Leather
 TH/O	Oak chair	4.25	-	-	€ 547	-	-	-	-	-	-	-	-
 TH/O/A	Oak armchair	5.5	-	-	€ 670	-	-	-	-	-	-	-	-
 TH/O/U	Oak chair upholstered	5	0.25	0.35	-	-	€ 603	€ 606	€ 612	€ 617	€ 628	€ 636	€ 645
 TH/O/A/U	Oak armchair upholstered	6.5	0.25	0.35	-	-	€ 725	€ 729	€ 734	€ 741	€ 752	€ 758	€ 768
TH/O/S	Oak chair stained	4.25	-	-	-	€ 622	-	-	-	-	-	-	-
TH/O/A/S	Oak armchair stained	5.5	-	-	-	€ 752	-	-	-	-	-	-	-
TH/O/S/U	Oak chair stained & upholstered	5	0.25	0.35	-	-	€ 677	€ 680	€ 688	€ 693	€ 702	€ 710	€ 722
TH/O/A/S/U	Oak armchair stained & upholstered	6.5	0.25	0.35	-	-	€ 809	€ 812	€ 817	€ 823	€ 836	€ 840	€ 851



LIST PRICES IN EURO EXCLUDING VAT

 = READY TO SHIP WITHIN 5 WORKING DAYS, SUBJECT TO STOCK

Writing tablet

Reference Code	Description	/OV Oak	/S Stained Oak	/L White Laminate
TH/TAB	Theo writing tablet	£280	£287	£285

Linking & Accessories

Reference Code	Description	Price
 /L1	Rigid, 2 point linking, straight rows	£15
 TH/TR1	Trolley for single stack	£1,042
TH/TR3	Trolley for triple stack	£1,293
 TH/BH	Book holder	£38

Theo chair with writing tablet

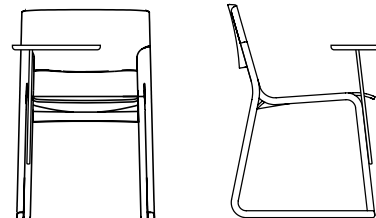

THEO CHAIR

Theo chair
width 510
depth 540
height 780
seat height 455

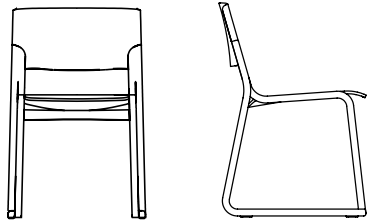

Theo armchair
arm height 660

Steel arm bracket:
Grey as standard.
Black optional.

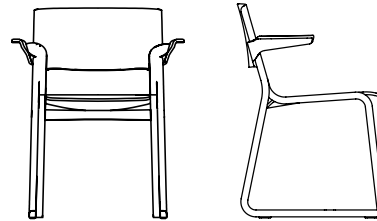

Theo chair &
armchair
upholstered
seat height 470

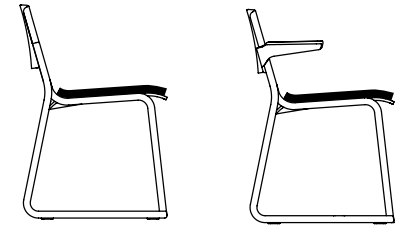



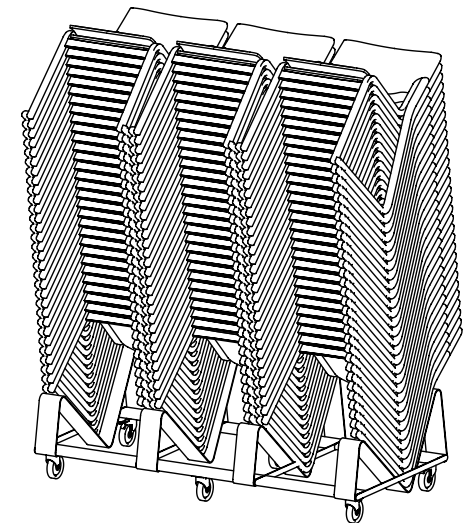
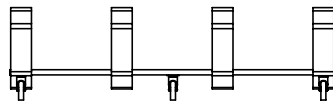
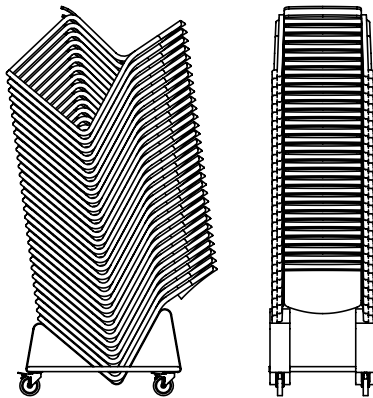

Theo trolley
single width 540
triple width 1565
depth 1060
height 1980





THEO STOOL

Reference Code	Description	Fabric Qty Linear M	Leather Qty Square M	Natural	Stained	COM	Fabric 1	Fabric 2	Fabric 3	Fabric 4	Fabric 5	Leather
 TH/O/LSTL	Oak low stool	-	-	€ 538	-	-	-	-	-	-	-	-
 TH/O/LSTL/U	Oak low stool upholstered	0.25	0.30	-	-	€ 634	€ 636	€ 643	€ 650	€ 662	€ 668	€ 679
TH/O/LSTL/S	Oak low stool stained	-	-	-	€ 605	-	-	-	-	-	-	-
TH/O/LSTL/S/U	Oak low stool stained & upholstered	0.25	0.30	-	-	€ 716	€ 718	€ 725	€ 732	€ 742	€ 751	€ 763
TH/O/MSTL	Oak medium stool	-	-	€ 597	-	-	-	-	-	-	-	-
TH/O/MSTL/U	Oak medium stool upholstered	0.25	0.30	-	-	€ 693	€ 696	€ 703	€ 710	€ 722	€ 728	€ 741
TH/O/MSTL/S	Oak medium stool stained	-	-	-	€ 685	-	-	-	-	-	-	-
TH/O/MSTL/S/U	Oak medium stool stained & upholstered	0.25	0.30	-	-	€ 781	€ 783	€ 792	€ 798	€ 810	€ 815	€ 828
 TH/O/HSTL	Oak high stool	-	-	€ 632	-	-	-	-	-	-	-	-
 TH/O/HSTL/U	Oak high stool upholstered	0.25	0.30	-	-	€ 727	€ 730	€ 738	€ 743	€ 757	€ 763	€ 777
TH/O/HSTL/S	Oak high stool stained	-	-	-	€ 719	-	-	-	-	-	-	-
TH/O/HSTL/S/U	Oak high stool stained & upholstered	0.25	0.30	-	-	€ 814	€ 817	€ 824	€ 831	€ 843	€ 851	€ 863

LIST PRICES IN EURO EXCLUDING VAT

 = READY TO SHIP WITHIN 5 WORKING DAYS, SUBJECT TO STOCK

Low stool
width 470
depth 410
height 455

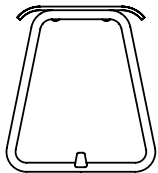

Medium stool
width 410
depth 390
height 670

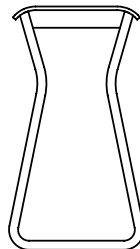

High stool
width 410
depth 390
height 750

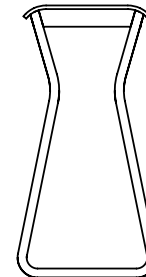



THEO HIGH CHAIR

Reference Code	Description	Fabric Qty Linear M	Leather Qty Square M	Natural	Stained	COM	Fabric 1	Fabric 2	Fabric 3	Fabric 4	Fabric 5	Leather
TH/O/HC	Oak high chair	-	-	€ 747	-	-	-	-	-	-	-	-
TH/O/HC/U	Oak high chair upholstered	0.25	0.35	-	-	€ 795	€ 804	€ 811	€ 816	€ 829	€ 834	€ 847
TH/O/HC/S	Oak high chair stained	-	-	-	€ 821	-	-	-	-	-	-	-
TH/O/HC/S/U	Oak high chair stained upholstered	0.25	0.35	-	-	€ 867	€ 878	€ 883	€ 890	€ 903	€ 908	€ 920

/A	Cost to add arms	€ 116
----	------------------	-------

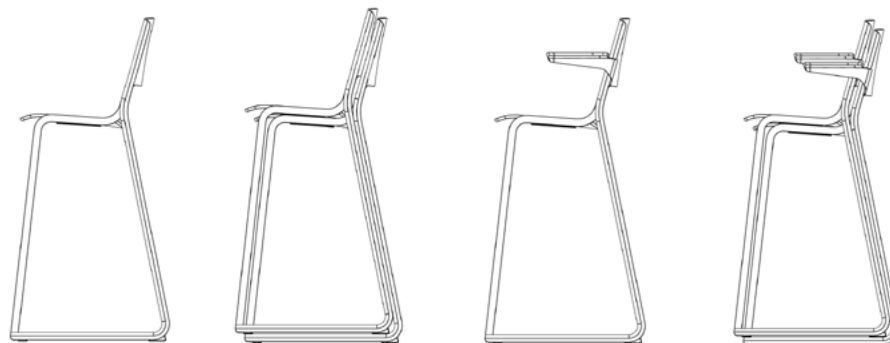

Theo High Chair

overall height: 1125mm
 seat height: 770mm
 overall depth: 540mm
 width without arms: 530mm
 width with arms: 640mm

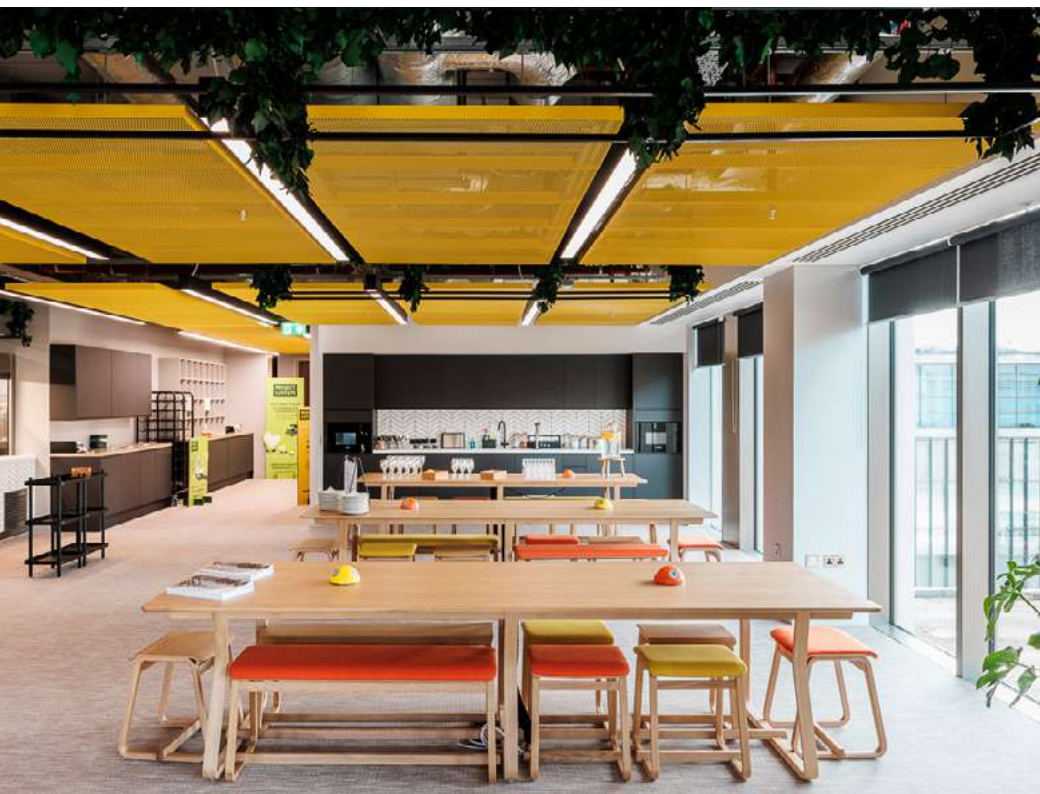



THEO BENCH

Reference Code	Description	Weight (kg)	Fabric Qty Linear M	Leather Qty Square M	Natural	Stained	COM	Fabric 1	Fabric 2	Fabric 3	Fabric 4	Fabric 5	Leather
 TH/O/B2	Oak 2 seat bench	7.00	-	-	€ 847	-	-	-	-	-	-	-	-
TH/O/B4	Oak 4 seat bench	16.00	-	-	€ 1,481	-	-	-	-	-	-	-	-
 TH/O/B2/U	Oak 2 seat bench upholstered	7.50	0.50	0.60	-	-	€ 1,034	€ 1,039	€ 1,053	€ 1,068	€ 1,093	€ 1,103	€ 1,129
TH/O/B4/U	Oak 4 seat bench upholstered	17.00	1.00	1.20	-	-	€ 1,829	€ 1,841	€ 1,869	€ 1,899	€ 1,944	€ 1,972	€ 2,023
TH/O/B2/S	Oak 2 seat bench stained	7.00	-	-	-	€ 973	-	-	-	-	-	-	-
TH/O/B4/S	Oak 4 seat bench stained	16.00	-	-	-	€ 1,702	-	-	-	-	-	-	-
TH/O/B2/S/U	Oak 2 seat bench stained & upholstered	7.50	0.50	0.60	-	-	€ 1,159	€ 1,166	€ 1,179	€ 1,195	€ 1,217	€ 1,230	€ 1,257
TH/O/B4/S/U	Oak 4 seat bench stained & upholstered	17.00	1.00	1.20	-	-	€ 2,050	€ 2,063	€ 2,091	€ 2,121	€ 2,167	€ 2,193	€ 2,242
TH/O/P2	Oak 2 seat bench with backrest	9.00	-	-	€ 1,310	-	-	-	-	-	-	-	-
TH/O/P3	Oak 3 seat bench with backrest	18.00	-	-	€ 2,159	-	-	-	-	-	-	-	-
TH/O/P2/U	Oak 2 seat bench with backrest upholstered	9.50	0.50	0.60	-	-	€ 1,490	€ 1,496	€ 1,510	€ 1,524	€ 1,548	€ 1,560	€ 1,585
TH/O/P3/U	Oak 3 seat bench with backrest upholstered	19.00	1.00	1.00	-	-	€ 2,467	€ 2,477	€ 2,505	€ 2,534	€ 2,580	€ 2,605	€ 2,615
TH/O/P2/S	Oak 2 seat bench with backrest stained	9.00	-	-	-	€ 1,493	-	-	-	-	-	-	-
TH/O/P3/S	Oak 3 seat bench with backrest stained	18.00	-	-	-	€ 2,465	-	-	-	-	-	-	-
TH/O/P2/S/U	Oak 2 seat bench with backrest stained & upholstered	9.50	0.50	0.60	-	-	€ 1,673	€ 1,679	€ 1,695	€ 1,708	€ 1,731	€ 1,744	€ 1,767
TH/O/P3/S/U	Oak 3 seat bench with backrest stained & upholstered	19.00	1.00	1.00	-	-	€ 2,771	€ 2,782	€ 2,811	€ 2,839	€ 2,884	€ 2,910	€ 2,920

LIST PRICES IN EURO EXCLUDING VAT

 = READY TO SHIP WITHIN 5 WORKING DAYS, SUBJECT TO STOCK

THEO BENCH

2 seat bench

width 1150 depth 410 height 460

4 seat bench

width 2250 depth 410 height 460

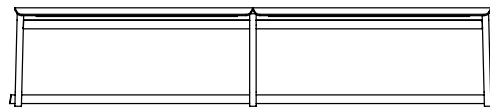

Upholstered bench
height 475



2 seat bench with backrest

width 1100 depth 520 height 780 seat height 470

3 seat bench with backrest

width 1800 depth 520 height 780 seat height 470

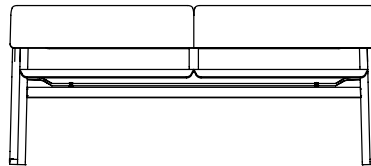

Upholstered bench with backrest
seat height 485



Bench with backrest stackable up to 6 high
depth 725 height 1150

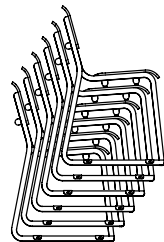



THEO MODULAR

Stage 1 - Choose your modular base frame size

Theo Modular - Base Frames				
Reference Code	Description	Number of legs	/OV Oak Frame	/SF Stained Frame Add-on Cost
TH/O/MOD1	Oak modular bench base 600mm wide to suit 1 seat/table	2	€ 504	€ 64
TH/O/MOD2	Oak modular bench base 1200mm wide to suit 2 seats/tables	2	€ 670	€ 80
TH/O/MOD3	Oak modular bench base 1800mm wide to suit 3 seats/tables	2	€ 831	€ 94
TH/O/MOD4	Oak modular bench base 2400mm wide to suit 4 seats/tables	3	€ 1,144	€ 124
TH/O/MOD5	Oak modular bench base 3000mm wide to suit 5 seats/tables	3	€ 1,308	€ 136

Stage 2 - Choose your seats and tables

Theo Modular - Seats										
Reference Code	Description	Fabric Qty Linear M	Leather Qty Square M	COM	Fabric 1	Fabric 2	Fabric 3	Fabric 4	Fabric 5	Leather
TH/MOD/US	Single upholstered seat	0.88	1.22	€ 158	€ 164	€ 182	€ 198	€ 226	€ 241	€ 381
TH/MOD/USB	Single upholstered seat and back	2	2.00	€ 390	€ 407	€ 447	€ 490	€ 557	€ 596	€ 730

Theo Modular - Tables				
Reference Code	Description	/L Laminate Top + Oak Frame	/OV Oak Top + Oak Frame	/STP Stained Top Add-on Cost
TH/MOD/T1/60SQ	Single 600(w) x 600(d)mm table section	€ 300	€ 301	€ 27
TH/MOD/T2/120/60	Single 1200(w) x 600(d)mm table section	€ 508	€ 506	€ 31

THEO MODULAR

Stage 3 - Choose your linking tables

Theo Modular - Linking Tables				
Reference Code	Description	/L Laminate Top + Oak Frame	/OV Oak Top + Oak Frame	/STP Stained Top Add-on Cost
TH/MOD/T/60SQ	Single 600mm x 600mm square	€ 292	€ 296	€ 27
TH/MOD/T/TR90	Single 90° Triangle	€ 267	€ 269	€ 23
TH/MOD/T/TR60	Single 60° Triangle	€ 268	€ 268	€ 24

Ordering Guide Examples



TH/O/MOD4/S3/US/US/T1/US/L

= Grey stained oak frame with 3 upholstered seats and 1 laminate top table with plywood edge



TH/O/MOD5/USB/USB/USB/T2/OV

= Oak frame with 3 upholstered seats & backs, plus 1 single 1200mm oak veneered table.



TH/O/MOD3/USB/USB/US

= Oak frame with 2 upholstered seats & backs, & 1 upholstered seat.

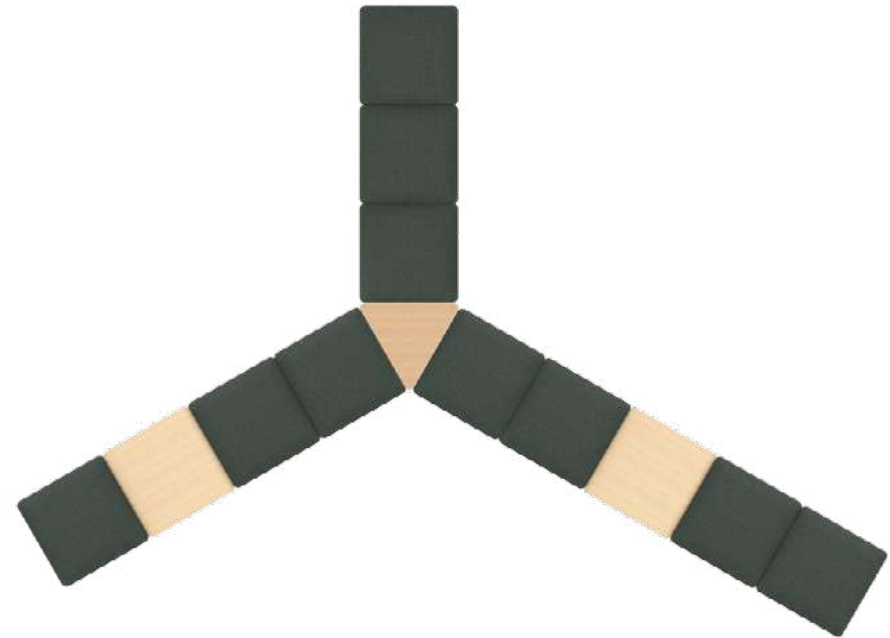

TH/O/MOD3/US/US/US

TH/O/MOD4/US/US/T1/US/OV

TH/O/MOD5/US/US/T1/US/US/OV

TH/MOD/T/TR60/OV

= 1 x oak bench with 3 upholstered seats, PLUS 1 x oak bench with 3 upholstered seats & 1 oak veneer table, PLUS 1 x oak bench with 4 upholstered seats & 1 oak veneer table, PLUS 1 x 60° linking oak veneer table.

THEO MODULAR

2 seat
height 440
width 1200
depth 600

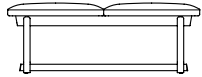

1 seat
with table
height 440
width 1200
depth 600

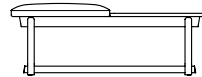

2 seat
with back
height 758
width 1200
depth 682

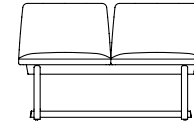

3 seat
height 440
width 1800
depth 600

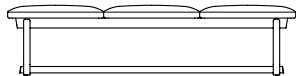

2 seat
with table
height 440
width 1800
depth 600

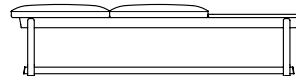

3 seat
with back
height 758
width 1800
depth 682

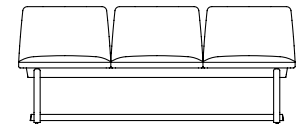

4 seat
height 440
width 2400
depth 600

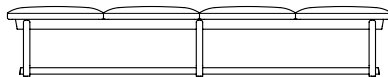

3 seat
with table
height 440
width 2400
depth 600

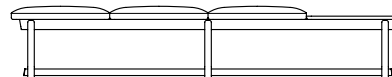

4 seat
with back
height 758
width 2400
depth 682

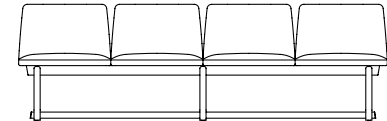

5 seat
height 440
width 3000
depth 600

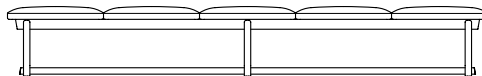

4 seat
with table
height 440
width 3000
depth 600

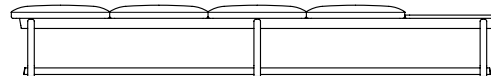

5 seat
with back
height 758
width 3000
depth 682

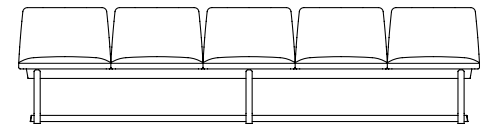

Connecting table shape options



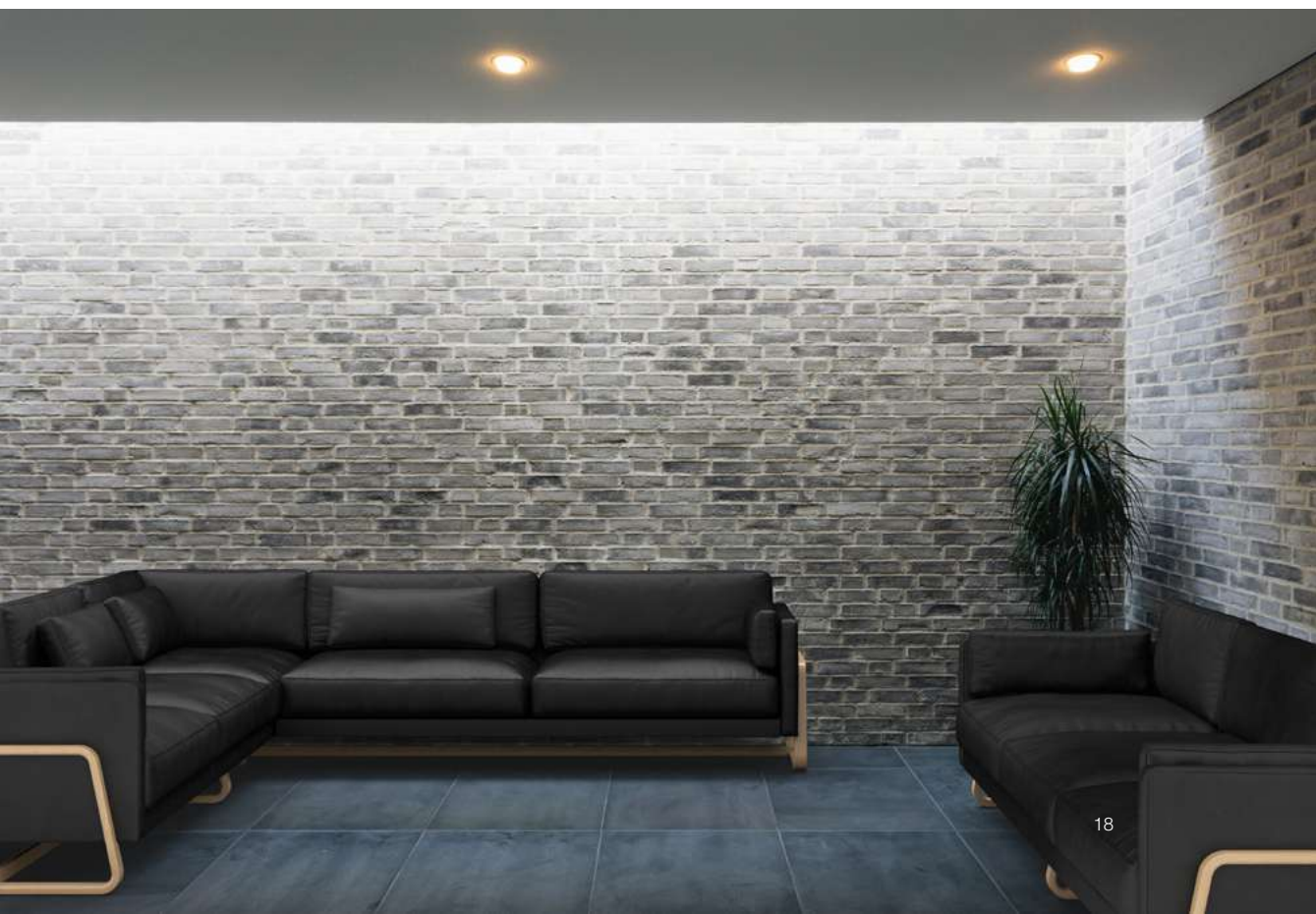

THEO LOUNGE

Theo club chair
width 780
depth 750
height 820
seat height 450

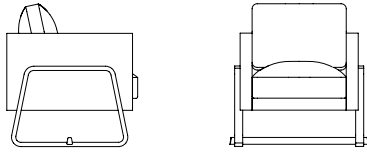

Theo lounge chair
width 1000
depth 880
overall height 750
seat height 400

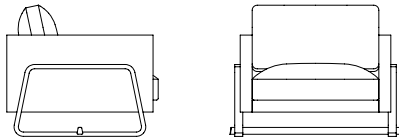

Theo sofa 2/3/4 seat
width 1600/2200/3170
depth 880
height 750
seat height 400

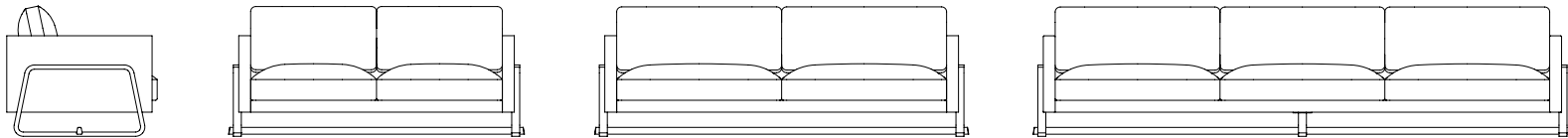

Theo sofa with 1 return
width 3110
depth 1960
height 750
seat height 400

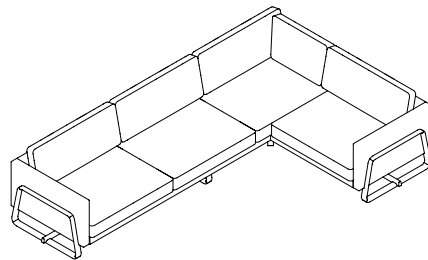

Theo sofa with 2 return
width 3110
depth 2925
height 750
seat height 400

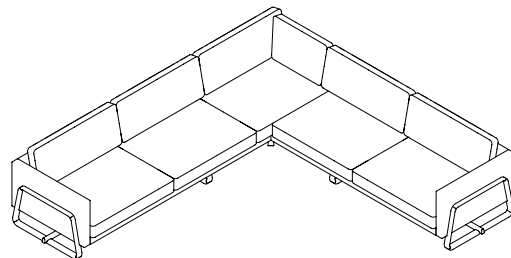

THEO LOUNGE

Reference Code	Description	Fabric Qty Linear M	Leather Qty Square M	COM	Fabric 1	Fabric 2	Fabric 3	Fabric 4	Fabric 5	Leather	/S Stained Legs Add-on Cost
TH/O/LNG/CL	Oak leg club chair	6.00	13.00	€ 2,350	€ 2,423	€ 2,595	€ 2,769	€ 3,043	€ 3,204	€ 4,675	€ 111
TH/O/LNG/CH	Oak leg lounge chair	7.50	16.00	€ 2,514	€ 2,585	€ 2,758	€ 2,931	€ 3,205	€ 3,367	€ 5,444	€ 60
TH/O/LNG/SOF2	Oak leg 2 seat sofa	10.00	21.00	€ 3,855	€ 3,973	€ 4,263	€ 4,550	€ 5,008	€ 5,275	€ 7,591	€ 66
TH/O/LNG/SOF3	Oak leg 3 seat sofa	11.00	23.50	€ 4,498	€ 4,629	€ 4,947	€ 5,264	€ 5,767	€ 6,061	€ 8,691	€ 68
TH/O/LNG/SOF4	Oak leg 4 seat sofa	12.00	25.20	€ 5,620	€ 5,763	€ 6,110	€ 6,455	€ 7,002	€ 7,327	€ 10,103	€ 84
TH/O/LNG/SOF3/RET1	Oak leg 3 seat sofa with 1 seat return (L-Shape)	18.00	37.80	€ 8,511	€ 8,725	€ 9,245	€ 9,765	€ 10,588	€ 11,069	€ 15,239	€ 139
TH/O/LNG/SOF3/RET2	Oak leg 3 seat sofa with 2 seat return (L-Shape)	22.00	46.20	€ 10,080	€ 10,344	€ 10,977	€ 11,612	€ 12,617	€ 13,206	€ 18,302	€ 139
TH/LNG/ACUS	Pair of sofa / armchair cushions	2.50	5.50	€ 377	€ 411	€ 488	€ 565	€ 685	€ 757	€ 1,425	-



THEO TABLE

Reference Code	Description	Top Size (mm)	Laminate Top		Oak Top		
			/L Laminate Top + Oak Frame	/SF Laminate Top + Stained Frame	/OV Oak Top + Oak Frame	/SF Oak Top + Stained Frame	/S Completely Stained Oak Table
TH/O/75RD	Oak round 3 leg	750 Ø	€ 1,051	€ 1,067	€ 1,086	€ 1,103	€ 1,128
TH/O/90RD	Oak round 4 leg	900 Ø	€ 1,340	€ 1,359	€ 1,381	€ 1,403	€ 1,427
TH/O/105RD	Oak round 4 leg	1050 Ø	€ 1,433	€ 1,452	€ 1,485	€ 1,506	€ 1,545
TH/O/120RD	Oak round 4 leg	1200 Ø	€ 1,472	€ 1,491	€ 1,526	€ 1,548	€ 1,586
TH/O/75SQ	Oak square 4 leg	750 x 750	€ 1,276	€ 1,298	€ 1,310	€ 1,331	€ 1,355
TH/O/90SQ	Oak square 4 leg	900 x 900	€ 1,340	€ 1,360	€ 1,380	€ 1,401	€ 1,423
TH/O/140/75	Oak rectangle 4 leg	1400 x 750	€ 1,854	€ 1,903	€ 1,926	€ 1,975	€ 2,010
TH/O/180/75	Oak rectangle 4 leg	1800 x 750	€ 1,900	€ 1,946	€ 1,973	€ 2,023	€ 2,073
TH/O/180/90	Oak rectangle 4 leg	1800 x 900	€ 2,024	€ 2,076	€ 2,101	€ 2,154	€ 2,204
TH/O/240/75	Oak rectangle 6 leg	2400 x 750	€ 2,384	€ 2,448	€ 2,469	€ 2,536	€ 2,590
TH/O/300/100	Oak rectangle 6 leg	3000 x 1000	€ 2,910	€ 2,975	€ 3,031	€ 3,097	€ 3,171

THEO TABLE

Theo table round
diameter 750
height 740

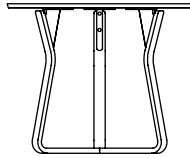

Theo table round
diameter 900/1050/1200
height 740

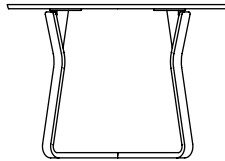

Theo table square
length/width 750 x 750
length/width 900 x 900
height 740

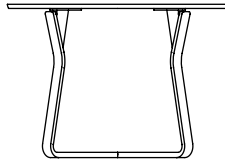

Theo table rectangle
length/width 1400 x 750
length/width 1800 x 750
length/width 1800 x 900
height 740

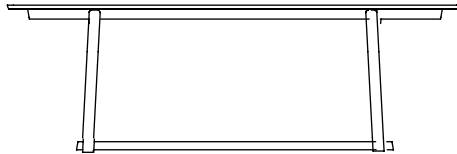

Theo table rectangle
length/width 2400 x 750
length/width 3000 x 1000
height 740

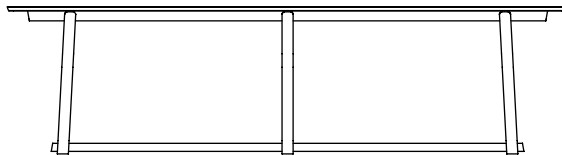

Top edge profile

THEO FOLDING TABLE

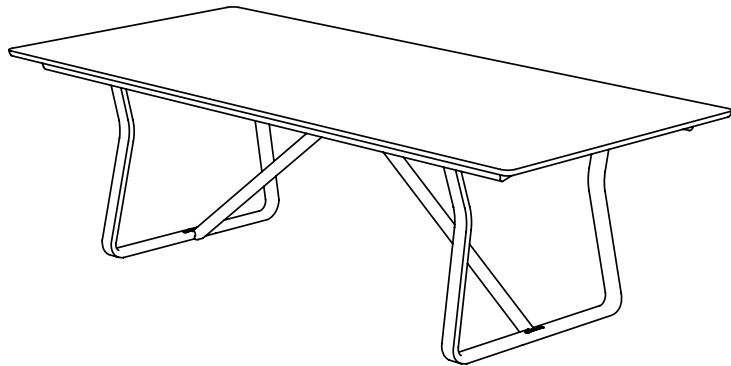

length/width 2200 x 900
length/width 2200 x 1100
length/width 2400 x 900
length/width 2400 x 1100
length/width 3000 x 1000
length/width 3000 x 1200
height 740



THEO FOLDING TABLE

Reference Code	Description	Top Size (mm)	Laminate Top		Oak Top			/LK Table Connector x 2 Per Table
			/L Laminate Top + Oak Frame	/SF Laminate Top + Stained Frame	/OV Oak Top + Oak Frame	/SF Oak Top + Stained Frame	/S Completely Stained Oak Table	
TH/O/220/90/FLG	Oak folding leg table	2200 x 900	€ 3,985	€ 4,283	€ 4,112	€ 4,409	€ 4,569	€ 38
TH/O/220/110/FLG	Oak folding leg table	2200 x 1100	€ 4,293	€ 4,590	€ 4,436	€ 4,734	€ 4,838	€ 38
TH/O/240/90/FLG	Oak folding leg table	2400 x 900	€ 4,161	€ 4,457	€ 4,361	€ 4,657	€ 4,834	€ 38
TH/O/240/110/FLG	Oak folding leg table	2400 x 1100	€ 4,540	€ 4,837	€ 4,690	€ 4,987	€ 5,105	€ 38
TH/O/300/100/FLG	Oak folding leg table	3000 x 1000	€ 5,022	€ 5,318	€ 5,196	€ 5,492	€ 5,625	€ 38
TH/O/300/120/FLG	Oak folding leg table	3000 x 1200	€ 5,487	€ 5,783	€ 5,693	€ 5,990	€ 6,150	€ 38

Theo Folding Table Transporter

Reference Code	Description	Price
TH/FLG/TRL	Theo Folding Table Transporter	€ 3,353



Top edge
profile

THEO EXTENDING TABLE

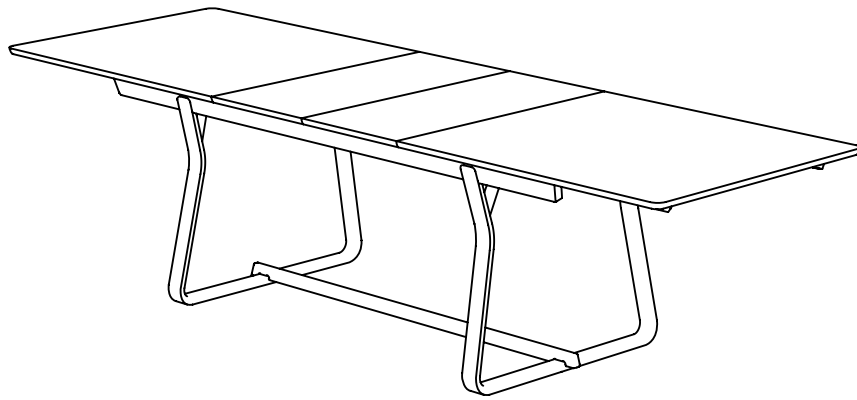

Extending Table
900mm x (2000 - 2800mm) x 740mm



THEO EXTENDING TABLE

Reference Code	Description	Top Size (mm)	Table Price	/SF Stained Frame Add-on Cost	/STP Stained Top Add-on Cost	/S Completely Stained Table Add-on Cost
TH/O/200/90/EXT/L	Oak frame + laminate top	2000 - 2800 x 900	€ 4,625	€ 142	-	-
TH/O/200/90/EXT/OV	Oak frame + oak top	2000 - 2800 x 900	€ 4,601	€ 142	€ 142	€ 285



Top edge
profile

THEO HIGH TABLE

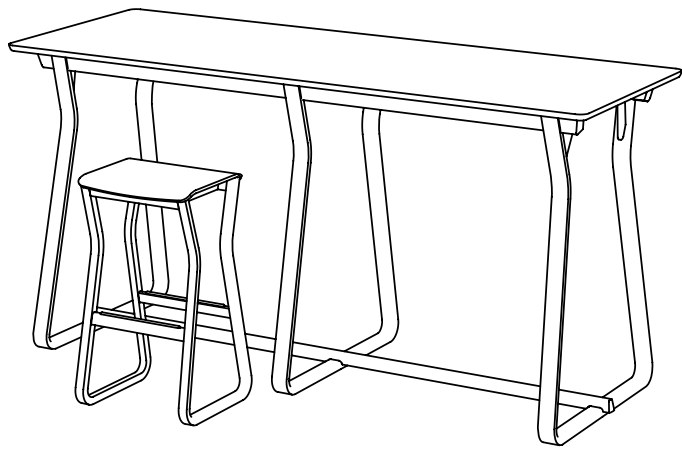

length/width 750 x 750
length/width 1500 x 750
length/width 1800 x 750
length/width 2400 x 750
length/width 3000 x 750
height 1050



THEO HIGH TABLE

Reference Code	Description	Top Size (mm)	Laminate Top		Oak Top		
			/L Laminate Top + Oak Frame	/SF Laminate Top + Stained Frame	/OV Oak Top + Oak Frame	/SF Oak Top + Stained Frame	/S Completely Stained Oak Table
TH/O/75/75/105H	Oak 750 x 750mm high table	750 x 750mm	€ 1,361	€ 1,384	€ 1,394	€ 1,418	€ 1,443
TH/O/150/75/105H	Oak 1500 x 750mm high table	1500 x 750mm	€ 1,976	€ 2,032	€ 2,045	€ 2,098	€ 2,150
TH/O/180/75/105H	Oak 1800 x 750mm high table	1800 x 750mm	€ 2,125	€ 2,179	€ 2,199	€ 2,253	€ 2,305
TH/O/2400/75/105H	Oak 2400 x 750mm high table	2400 x 750mm	€ 2,677	€ 2,749	€ 2,763	€ 2,835	€ 2,876
TH/O/3000/75/105H	Oak 3000 x 750mm high table	3000 x 750mm	€ 3,092	€ 3,170	€ 3,203	€ 3,283	€ 3,327



Top edge
profile



THEO HEIGHT ADJUSTABLE TABLE

Reference Code	Top Size (mm)	Laminate Top		Oak Top	
		/L Laminate Top + Oak Frame	/SF Laminate Top + Stained Frame	/OV Oak Top + Oak Frame	/S Completely Stained Oak Table
TH/O/HAT/1890	1800 x 900	€ 3,891	€ 3,943	€ 3,993	€ 4,044
TH/O/HAT/2010	2000 x 1000	€ 4,671	€ 4,723	€ 4,701	€ 4,753
TH/O/HAT/2410	2400 x 1000	€ 5,616	€ 5,668	€ 5,647	€ 5,699

/LO/OV	Lift out insert in table top, solid oak	€ 226
/PDCO	Unlined cut-out for client's own power unit	€ 31
/PD	Cost to add 1 No CMD Face Unit with power, 1 twin USB Type A + Type C charger in shelf	€ 820
/MOB	Mobile castors	€ 286



Top edge profile

length/width 1800 x 900
length/width 2000 x 1000
length/width 2400 x 1000
height 740 - 1050

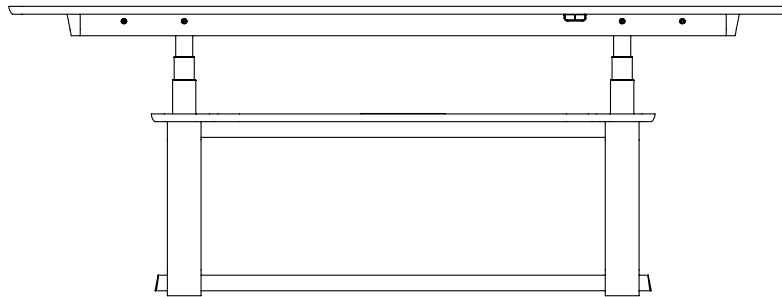
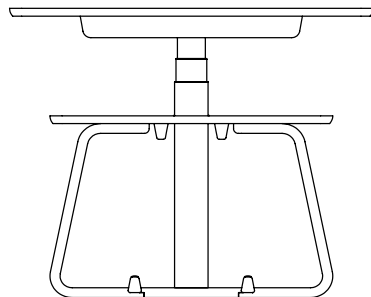



THEO WORKTABLE



width/length 1200 x 1500
width/length 1200 x 3000
width/length 1200 x 4500
width/length 1200 x 6000
width/length 1600 x 1500
width/length 1600 x 3000
width/length 1600 x 4500
width/length 1600 x 6000
height 740



THEO WORKTABLE

Reference Code	Top Size (mm)	Laminate Top		Oak Top		
		/L Laminate Top + Oak Frame	/SF Laminate Top + Stained Frame	/OV Oak Top + Oak Frame	/SF Oak Top + Stained Frame	/S Completely Stained Oak Table
TH/O/WT/120/150	1200 x 1500	€ 3,151	€ 3,234	€ 3,040	€ 3,123	€ 3,184
TH/O/WT/120/300	1200 x 3000	€ 5,377	€ 5,529	€ 5,154	€ 5,305	€ 5,425
TH/O/WT/120/450	1200 x 4500	€ 8,025	€ 8,248	€ 7,692	€ 7,917	€ 8,102
TH/O/WT/120/600	1200 x 6000	€ 10,668	€ 10,964	€ 10,230	€ 10,528	€ 10,779
TH/O/WT/160/150	1600 x 1500	€ 4,011	€ 4,093	€ 3,764	€ 3,847	€ 3,977
TH/O/WT/160/300	1600 x 3000	€ 6,867	€ 7,016	€ 6,372	€ 6,520	€ 6,784
TH/O/WT/160/450	1600 x 4500	€ 10,432	€ 10,655	€ 9,681	€ 9,904	€ 10,294
TH/O/WT/160/600	1600 x 6000	€ 13,997	€ 14,293	€ 12,993	€ 13,291	€ 13,808

Accessories

Reference Code	Description	Cost per 2 Person Module	Cost per Cut-out	Cost per Insert	Stain Add-on per 2 Person Module	Stain Add-on per Insert
/LCO	Lamp cut-out	€ 31	-	-	-	-
/PDCO	Power & data cut-out	€ 61	€ 31	-	-	-
/LOI	Lift-out oak/ash insert	€ 457	-	€ 229	€ 7	€ 2

Lighting

Reference Number	Description	Cost per light
/PL	Parasol light	€ 1,294

As per *Fig 1*, we recommend each user has access to two sources of light. Each light is supplied with a touch-on/off switch.

Fig 1. Indicative spacing of Parasol Light

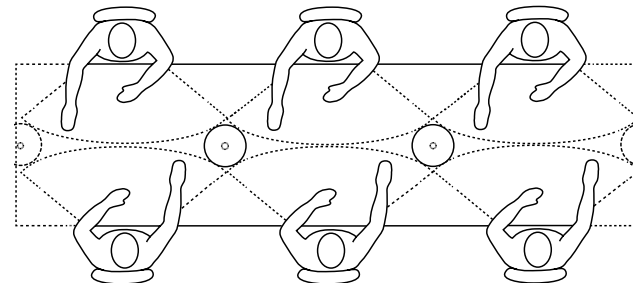

/PL Parasol Light

width 245 Ø
height 586

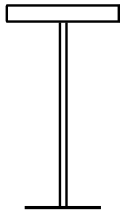
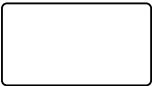

Fig 2. Parasol Light



THEO WORKTABLE

TH/O/WT/120/150
length 1500
width 1200



TH/O/WT/120/300
length 3000
width 1200

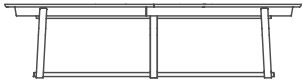

TH/O/WT/120/450
length 4500
width 1200



TH/O/WT/120/600
length 6000
width 1200

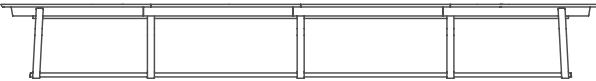

TH/O/WT/160/150
length 1500
width 1600

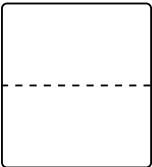

TH/O/WT/160/300
length 3000
width 1600

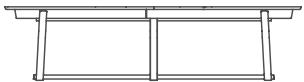
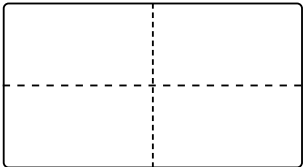

TH/O/WT/160/450
length 4500
width 1600

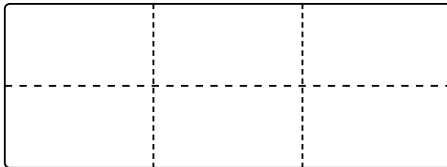

TH/O/WT/160/600
length 6000
width 1600

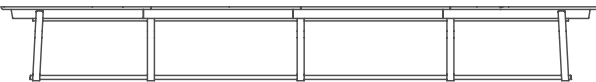
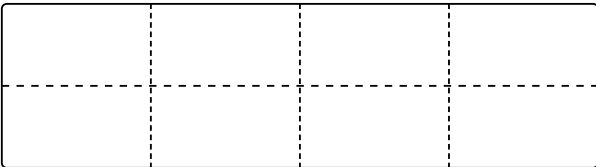

Top edge profile



THEO WORKHUB

Reference Code	Description	Top Size (mm)	Laminate Top		Oak Top		
			/L Laminate Top + Oak Frame	/SF Laminate Top + Stained Frame	/OV Oak Top + Oak Frame	/SF Oak Top + Stained Frame	/S Completely Stained Oak Table
TH/O/WH/120	4 leg standard height workhub	1200 Ø	€ 1,897	€ 1,927	€ 2,062	€ 2,116	€ 2,134
TH/O/WH/100	3 leg poseur height workhub	1000 Ø	€ 1,375	€ 1,398	€ 1,495	€ 1,534	€ 1,546

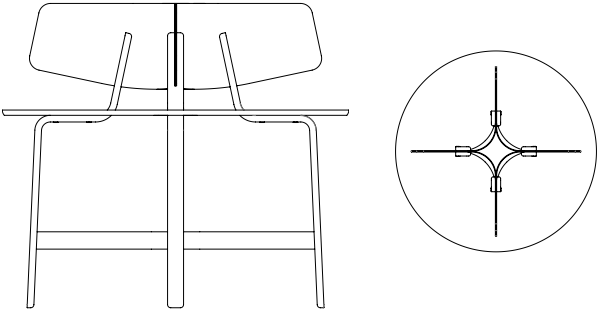

Theo workhub - standard height
1200 Ø X 740

Height to top of felt screen: 1140

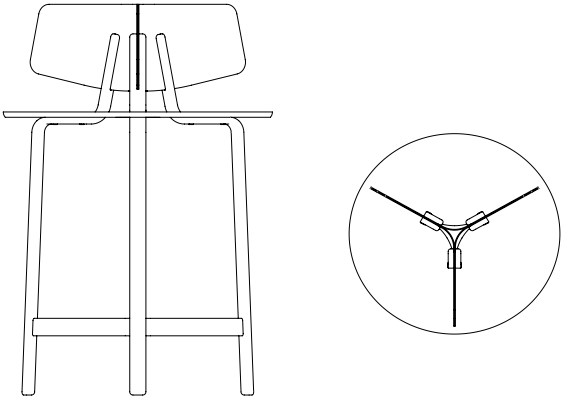

Theo workhub - poseur height
1000 Ø X 1050

Height to top of felt screen: 1450



THEO HEIGHT ADJUSTABLE BOOTH

Reference Code	Description	Module Type	Dimensions (mm) W x D x H	Fabric Qty Linear M	COM*	Camira Mainline Flax (Fabric Band 2)	/SF Stained Legs & Shelves Add-on Cost	/S Stained desk top, legs & shelves Add-on Cost
TH/O/140/80/145H/HAB	/L - Laminate desk top - oak legs & shelves	Individual	1400 x 800 x 1450	7.70	€ 4,340	€ 4,660	€ 235	-
TH/O/140/80/145H/HAB/EXT/LH	/L - Laminate desk top - oak legs & shelves	Left-hand	1400 x 800 x 1450	7.70	€ 4,189	€ 4,444	€ 235	-
TH/O/140/80/145H/HAB/EXT/MID	/L - Laminate desk top - oak legs & shelves	Middle	1400 x 800 x 1450	6.10	€ 3,691	€ 3,946	€ 235	-
TH/O/140/80/145H/HAB/EXT/RH	/L - Laminate desk top - oak legs & shelves	Right-hand	1400 x 800 x 1450	6.10	€ 3,320	€ 3,574	€ 235	-
TH/O/140/80/145H/HAB	/OV - Oak desk top - oak legs & shelves	Individual	1400 x 800 x 1450	7.70	€ 4,423	€ 4,744	-	€ 278
TH/O/140/80/145H/HAB/EXT/LH	/OV - Oak desk top - oak legs & shelves	Left-hand	1400 x 800 x 1450	7.70	€ 4,273	€ 4,527	-	€ 278
TH/O/140/80/145H/HAB/EXT/MID	/OV - Oak desk top - oak legs & shelves	Middle	1400 x 800 x 1450	6.10	€ 3,775	€ 4,030	-	€ 278
TH/O/140/80/145H/HAB/EXT/RH	/OV - Oak desk top - oak legs & shelves	Right-hand	1400 x 800 x 1450	6.10	€ 3,713	€ 3,968	-	€ 278

Notes

* COM fabric must be wider than 140cm

Theo height adjustable booth
width 1400
depth 800
height 1450

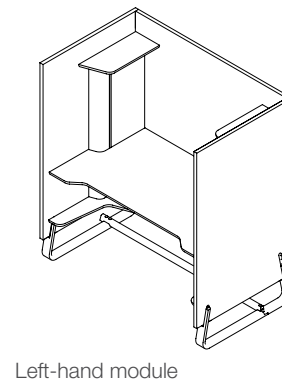
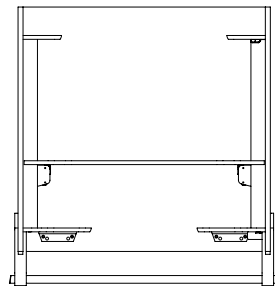
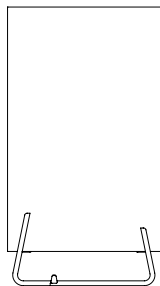

Left-hand module

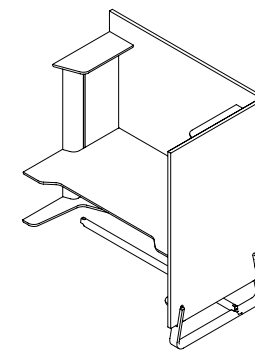

Middle module

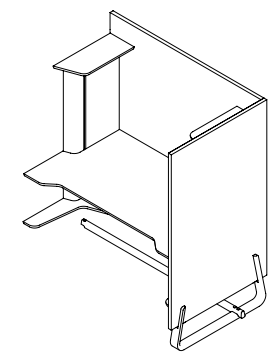

Right-hand module



THEO HIGH-BACK SOFA

Reference Code	Description	Fabric Qty Linear M	Leather Qty Linear M	COM	Fabric 1	Fabric 2	Fabric 3	Fabric 4	Fabric 5	Leather	/S Stained Frame Add-on Cost
TH/O/LNG/CH/HB	High-back chair, oak leg	9	26.00	€ 4,369	€ 4,520	€ 4,883	€ 5,248	€ 5,824	€ 6,161	€ 9,034	€ 83
TH/O/LNG/CH/HB/TAB/L	High-back lounge chair with laminate top tablet, oak leg	13.00	27.50	€ 5,190	€ 5,346	€ 5,727	€ 6,106	€ 6,703	€ 7,057	€ 10,137	€ 83
TH/O/LNG/CH/HB/TAB/OV	High-back lounge chair with oak top tablet, oak leg	13.00	27.50	€ 5,185	€ 5,342	€ 5,721	€ 6,099	€ 6,699	€ 7,049	€ 10,131	€ 83
TH/O/LNG/SOF2/HB	High-back 2 seat sofa, oak leg	14.00	28.50	€ 5,213	€ 5,383	€ 5,790	€ 6,199	€ 6,844	€ 7,222	€ 10,314	€ 69
TH/O/LNG/SOF3/HB	High-back 3 seat sofa, oak leg	17.50	36.00	€ 6,658	€ 6,868	€ 7,378	€ 7,888	€ 8,695	€ 9,169	€ 13,109	€ 81
TH/LNG/ACUS	Pair of sofa / armchair cushions	2.50	5.50	€ 371	€ 403	€ 479	€ 553	€ 673	€ 743	€ 1,395	-

Arm cushions can be specified - but not with arm or tablet.

High-back Sofa Accessories

Reference Code	Description	Oak Finish	/S Stain Add-on Cost
TH/O/LNG/SOF/HB/ARM	Oak arm for high-back 2 or 3 seat sofa	€ 90	€ 6
TH/O/LNG/SOF/HB/TAB	Oak tablet for high-back 2 or 3 seat sofa	€ 216	€ 16

THEO HIGH-BACK SOFA

Theo high-back chair

width 926
depth 1124
overall height 1400
seat height 463

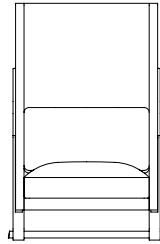
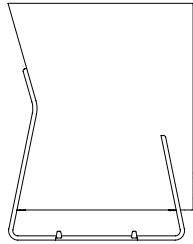

Theo high-back lounge chair with tablet

width 1416
depth 1124
overall height 1400
seat height 463

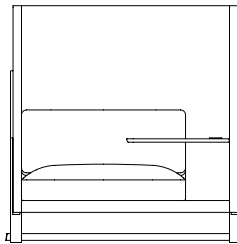
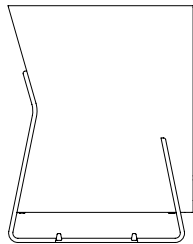

Theo high-back 2 seat sofa

width 1666
depth 1124
overall height 1400
seat height 463

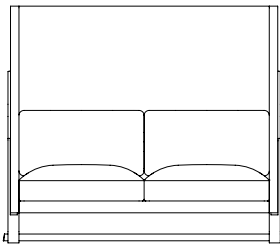
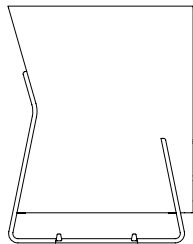

Theo high-back 3 seat sofa

width 2406
depth 1124
overall height 1400
seat height 463

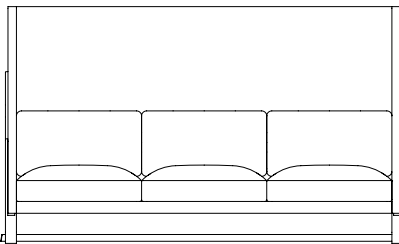
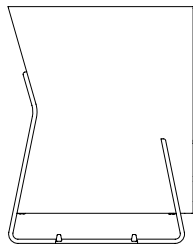



THEO MEETING BOOTH

Reference Code	Description	Fabric Qty Linear M	Leather Qty Square M	COM	Fabric 1	Fabric 2	Fabric 3	Fabric 4	Fabric 5	Leather	/S Stained Booth Legs Add-On Cost	/SF Stained Table Legs Add-On Cost	/STP Stained Table Top Add-On Cost
TH/O/LNG/HB/BTH/2ST	2 seat with oak frame	27.50	57.50	€ 9,832	€ 10,164	€ 10,964	€ 11,766	€ 13,034	€ 13,778	€ 20,160	€ 213	-	-
TH/O/LNG/HB/BTH/4ST/L	4 seat with laminate top table oak frame	30.50	62.50	€ 13,038	€ 13,404	€ 14,294	€ 15,183	€ 16,589	€ 17,415	€ 24,232	€ 175	€ 41	-
TH/O/LNG/HB/BTH/4ST/OV	4 seat with oak top table oak frame	30.50	62.50	€ 13,106	€ 13,474	€ 14,364	€ 15,249	€ 16,657	€ 17,483	€ 24,302	€ 175	€ 41	€ 32
TH/O/LNG/HB/BTH/4ST/L	6 seat with laminate top table oak frame	37.50	77.50	€ 16,006	€ 16,458	€ 17,551	€ 18,644	€ 20,371	€ 21,389	€ 29,902	€ 195	€ 41	-
TH/O/LNG/HB/BTH/4ST/OV	6 seat with oak top table oak frame	37.50	77.50	€ 16,078	€ 16,530	€ 17,624	€ 18,715	€ 20,443	€ 21,461	€ 29,974	€ 195	€ 41	€ 42

Theo meeting booth 2 seater
width 3290
depth 926
overall height 1400
seat height 510

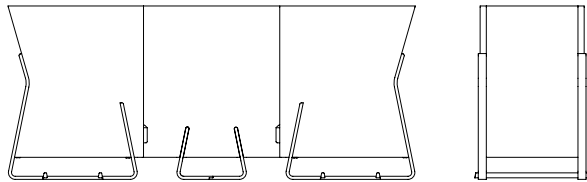

Theo meeting booth 4 seater
width 3290
depth 1666
overall height 1400
seat height 510

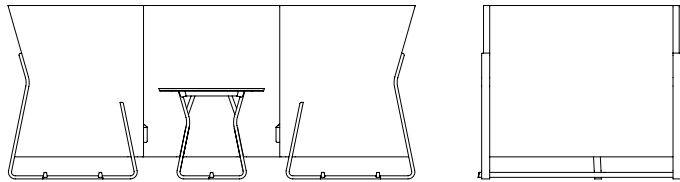

Theo meeting booth 6 seater
width 3290
depth 2406
overall height 1400
seat height 510

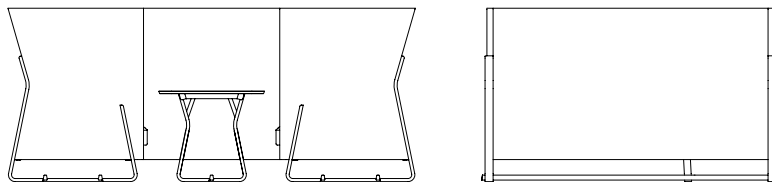



THEO COFFEE TABLE & CADDY

Reference Code	Description	/OV Oak Carcase and Frame	/STF Stained Frame Add-on Cost	/STC Stained Carcase Add-on Cost	/ST Complete Stained Coffee Table Add-on Cost
TH/O/95/80/36H	Oak coffee table	€ 1,661	€ 49	€ 61	€ 112

Theo coffee table
width 1050
depth 800
height 360
shelf depth 150

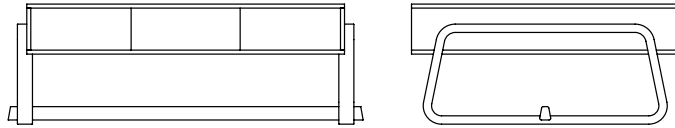

Reference Code	Description	/OV Oak Carcase and Frame	/STF Stained Frame Add-on Cost	/STC Stained Carcase Add-on Cost	/ST Complete Stained Caddy Add-on Cost
TH/O/CDY	Oak caddy	€ 1,126	€ 34	€ 140	€ 174

Theo caddy
width 600
depth 410
height 450

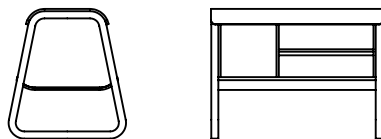



THEO CREDENZA

Reference Code	Door / Drawer Combination (left to right)	Dimensions (mm) L x D x H	Number Of Shelves	/OV Oak Cabinet, Frame, Doors, Drawers	/STF Stained Leg Frame Add-on Cost	/STC Stained Cabinet And Shelves Add-on Cost	/SCC Lacquered Solid Colour MDF Cabinet And Shelves Cost Reduction	/STD Stained Doors Add-on Cost	/SCD Lacquered Solid Colour MDF Doors Cost Reduction	/STDR Stained Drawers Add-on Cost	/SCDR Lacquered Solid Colour MDF Drawers Add-on Cost
TH/O/CR120/75H/DD	Door + Door	1260 x 525 x 750	2	€ 3,446	€ 51	€ 196	-€ 220	€ 28	-€ 49	-	-
TH/O/CR120/75H/DDR	Door + Drawers	1260 x 525 x 750	1	€ 3,762	€ 51	€ 160	-€ 220	€ 14	-€ 24	€ 42	€ 59
TH/O/CR180/75H/DDD	Door + Door + Door	1820 x 525 x 750	3	€ 4,970	€ 77	€ 291	-€ 317	€ 44	-€ 79	-	-
TH/O/CR180/75H/DDRD	Door + Drawers + Door	1820 x 525 x 750	2	€ 5,289	€ 77	€ 251	-€ 317	€ 30	-€ 51	€ 42	€ 59
TH/O/SH	Additional oak shelf		1	€ 194	-	€ 39	-€ 18	-	-	-	-

Shelf finish matches cabinet finish.

Theo credenza
width 1260
depth 525
height 750

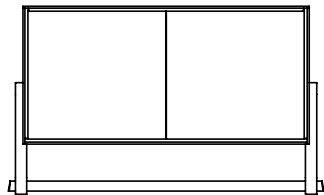
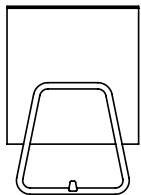

Theo credenza
width 1820
depth 525
height 750

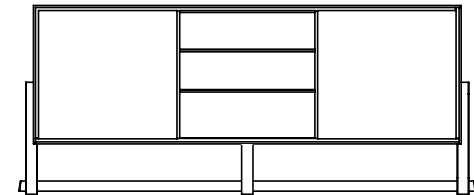
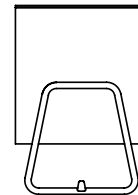



THEO COAT STAND

Reference Code	Description	Natural Oak / Ash	/S Stained Coat Stand
TH/O/CRK 	Theo coat stand	€ 673	€ 713

LIST PRICES IN EURO EXCLUDING VAT

 = READY TO SHIP WITHIN 5 WORKING DAYS, SUBJECT TO STOCK

Theo coat stand
width 605
height 1590

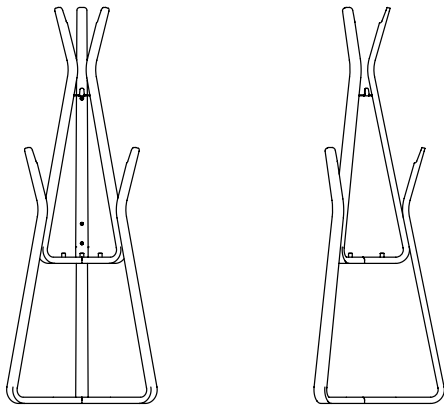



THEO SHELVING

Reference Code	Description	Natural Oak	/SF Stained Frame Add-on Cost
TH/O/SHLV/1800	Theo oak shelving 1800mm wide	€ 4,051	€ 4,374
TH/O/SHLV/PLT/1800	Theo oak shelving with 6no plant troughs 1800mm wide	€ 5,352	€ 5,686
TH/O/SHLV	Theo oak shelving 2400mm wide	€ 4,993	€ 5,390
TH/O/SHLV/PLT	Theo oak shelving with 8no plant troughs 2400mm wide	€ 6,711	€ 7,124

Theo standard shelves

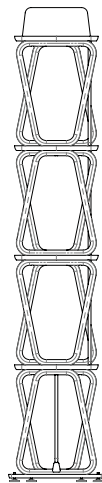
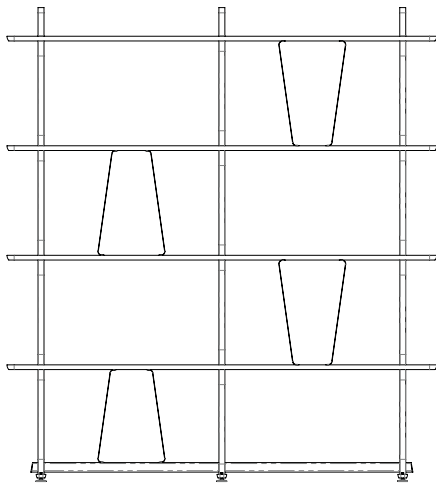
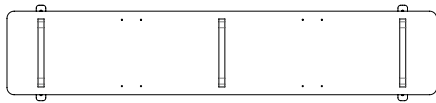

Theo biophilic shelves

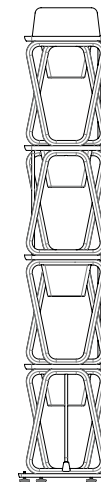
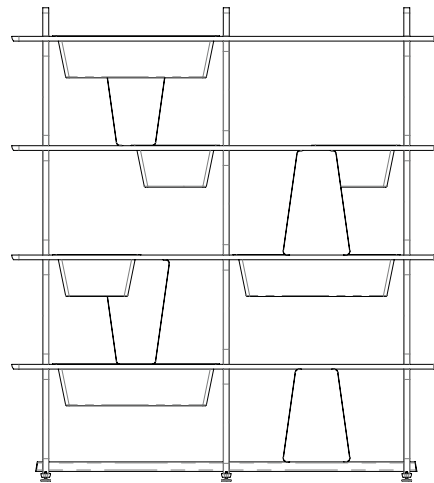
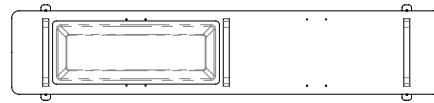

height 1985
width 1800/2400
depth 400



THEO SPACE DIVIDER

1. CHOOSE YOUR SPACE DIVIDER		Dimensions (mm)	Fabric Qty Linear M	COM	Camira Mainline Flax (Fabric Band 2)	/S Stained Frame Add-on Cost
Reference Code	Description					
TH/O/120/124H/SPD	Natural oak space divider screen, short	1215 w x 1240 h	2.80	€ 1,257	€ 1,370	€ 40
TH/O/120/183H/SPD	Natural oak space divider screen, tall	1215 w x 1825 h	4.00	€ 1,480	€ 1,644	€ 42
TH/O/240/153H/SPD	Natural oak space divider screen, long	2400 w x 1525 h	7.60	€ 2,528	€ 2,839	€ 59

2. CHOOSE YOUR ACCESSORIES		Dimensions (mm)	Price	/S Stain Add-on Cost
Reference Code	Description			
TH/O/112/SH	Oak shelf	1120 x 125	€ 171	€ 13
TH/O/HK	Oak coat hook	310 h	€ 59	€ 8
TH/O/MOB	Oak mobile Castor	-	€ 288	€ 9

Theo short space divider
width 1215
depth 380
height 1240

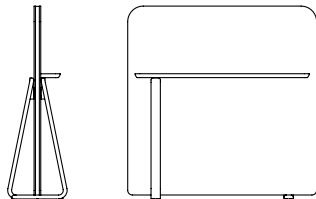

Theo tall space divider
width 1215
depth 380
height 1825

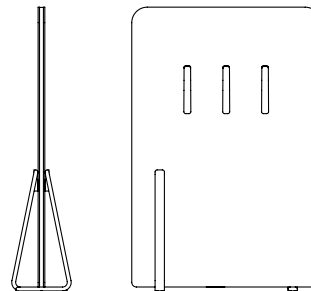

Theo long space divider
width 2400
depth 380
height 1525

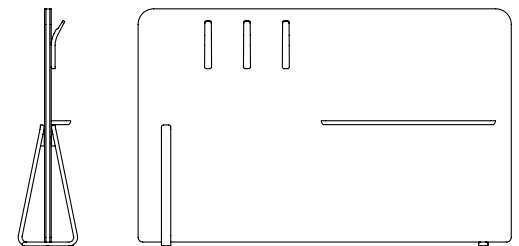



THEO MEDIA SCREEN

1. CHOOSE YOUR MEDIA SCREEN		Height (mm)	Fabric Qty Linear M	COM	Camira Mainline Flax (Fabric Band 2)	/S Stained Frame Add-on Cost
Reference Code	Description					
TH/O/MSCR/120/150H	Oak upholstered media screen 1525mm high	1525	3.20	€ 2,082	€ 2,221	€ 11
TH/O/MSCR/120/180H	Oak upholstered media screen 1825mm high	1825	4	€ 2,267	€ 2,429	€ 18

2. CHOOSE YOUR ACCESSORIES		Price	/S Stain Add-on Cost
Reference Code	Description		
TH/O/112/SH	Oak shelf	€ 155	€ 10
TH/O/MOB	Oak mobile Castor	€ 274	€ 9
/MAGSCR	Abstracta Magvision Screen, White Glass 980 x 630mmH	€ 598	-
/MAGPK	Magvision screen accessory pack (whiteboard pens and wipes)	€ 249	-
/PD	Power & Data Unit - Twin USB (A+C), 1 Power, + 1 HDMI	€ 788	-
/BMS	Universal fixed bracket for monitor (monitor not supplied).	€ 185	-

When a monitor bracket (/BMS) is specified, the screen will come with a 80mm Ø monitor cable grommet and cut-out as standard. This is to allow for the connection of the user's own monitor.

Theo Media Screen
width 1200
overall depth 410
overall height 1525

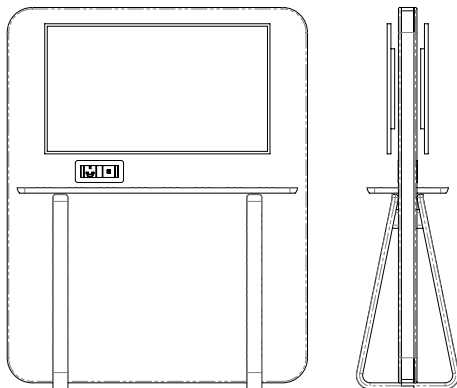

Theo Media Screen
width 1200
overall depth 410
overall height 1825

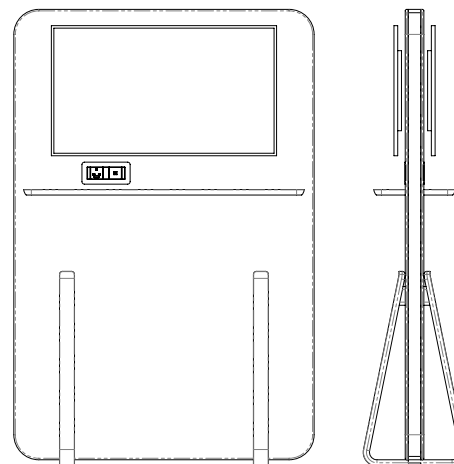

THEO FINISHES

Standard Wood Finishes

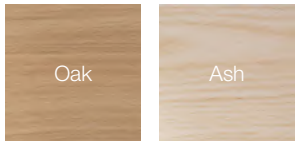
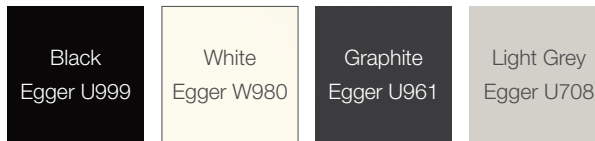
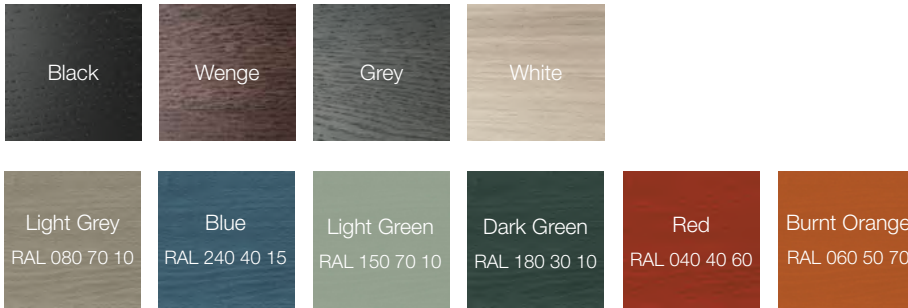

Table Laminates



Stains



Fabrics

Fabric 1

Camira - Rivet
Made from 100% REPREVE®, a brand of recycled polyester made from used plastic bottles.

Camira - Xtreme
100% post-consumer recycled polyester

Camira - Era

Camira - Gravity

Camira - Vita Vinyl

Inloom - Alba

Inloom - Bondai

Gabriel - Blend

Gabriel - Cura

Fabric 2

Camira - Oceanic
Woven using SEAQUAL yarn, for every 2kgs (4 metres) of Oceanic fabric sold, 1kg of waste is removed from the ocean.

Camira - Urban
Made from 100% recycled polyester

Camira - Aspect

Camira - Main Line Plus

Camira - Main Line Flax

Svensson - Semi

Svensson - Easy

Spradling Valencia

Agua - Paint Pot Vinyl

Gabriel - Step

Gabriel - Soft Next

Fabric 3

Camira - Aquarius

Camira - Main Line Twist

Camira - Sumi

Camira - Synergy

Camira - Blazer

Camira - Hemp

Camira - Silk

Kvadrat - Reflect

Svensson - Khaki

Svensson - Harper

Svensson - Heritage

Skai - Palma faux leather

Skai - Sotega faux leather

Skai - Tundra faux leather

Fabric 4

Kvadrat - Revive 1
made from 100% post-consumer recycled polyester.

Kvadrat - Remix 3

Bute - Elgin

Camira - Craggan Flax

Camira - Kyoto

Camira - Regent

Svensson - Poppy

Svensson - Step

Svensson - Rami

Vescom - Cres

Vescom - Samar

Gabriel - Umber

Fabric 5

Kvadrat - Re-Wool
Made from 45% recycled wool.

Kvadrat - Melange Nap

Bute - Alchemy

Textile Mania - Satellite

Textile Mania - Hotshot

Leather

Bridge of Weir Grampian

TERMS & CONDITIONS OF SALE

These terms and conditions of sale are available on request and for inspection at the company's registered office.

1. Acceptance of Orders

Orders are accepted, manufactured and invoiced in accordance with the quantities, specification, price and payments terms as contained in New Design Group Order Confirmation paperwork. New Design Group should be notified immediately of any discrepancies.

2. Lead Times

Lead times quoted are applicable from receipt by New Design Group of full order specification.

3. Ownership of Goods

Notwithstanding delivery and the passing of risk, property in and title to the goods shall remain with the seller until the seller has received payment of the full price of

- (a) all Goods and/or Services the Subject of the Contract and
- (b) all other goods and/or services supplied by the seller to the buyer under any contract whatsoever.

Payment of the full price shall include, without limitation, the amount of any interest or other sum payable under the terms of this and all other contracts between the seller and buyer.

4. General

These conditions shall apply to and govern all contracts for the supply of goods and Services by New Design Group Ltd (hereinafter called "the Company") and shall prevail over any inconsistent terms or conditions contained in or referred to in this order or in correspondence or elsewhere and all or any arrangements to the contrary are hereby extinguished. The Term "goods" shall where the context so permits include units, parts, accessories, repairs, fitments and services.

5. Prices and Payments

a) Subject to the provisions of Clause 2(c) whilst every effort will be made to maintain prices as quoted, the Company will only accept orders at prices ruling on the day of despatch, and such price shall be fixed at the Company's discretion after taking into account any increase in the cost of materials, transport and any other relevant factors: and the buyer hereby agrees to pay the price as invoiced. The buyer also agrees to pay for any loss or extra costs incurred by the Company through any request or instruction or lack of instructions on the part of the buyer, its employees or contractors. Unless otherwise indicated in the Company's quotation no discount of any kind is allowable, prices being strictly net.

(b) V.A.T. (if applicable) will be charged at the prevailing rate at time of dispatch.

(c) Unless it has otherwise been agreed in writing, orders are accepted on the condition that payment is paid in full on or prior to the taking of delivery of goods unless an approved credit account has been opened for the buyer by the Company. Payment of any instalment due is a condition precedent to further deliveries, and the Company shall have the right to terminate any contract or supply when an instalment or payment is in arrears. If an invoice is not agreed then it is incumbent upon the buyer to communicate this fact to the Company immediately as under no circumstances will any dispute be acknowledged by the Company more than 7 days after the date of the invoice. Where not otherwise expressly stated all payments are to be made at the main premises of the Company.

TERMS & CONDITIONS OF SALE

(d) Title to the goods shall in no case pass from the Company until the full contract or invoiced price has been received. If a cheque is tendered by the buyer it shall not be treated as payment until it has been cleared by the Company's Bank. The Company shall in any event have a particular and general lien over the goods sold and for all claims and monies owing by the buyer to the Company under any contract whatsoever or in any other way whatsoever, and the Company shall be entitled to the return of all goods not paid for in full at the buyer's expense in the event of any failure to pay in accordance with these conditions or any specific amendment thereto agreed in advance in writing by the Company with the buyer.

(e) The Company may charge interest at 4% above the base rate from time to time of HSBC Bank Plc on any amount not received by the due date until such amount is received, both before and after judgment.

6. Carriage and Delivery

Carriage is affected at the Company's option and appropriate charges will be made for such carriage based on current Carriage Standard Rates. Although every effort will be made to effect prompt delivery, the Company cannot be held responsible for loss or damage due to delay in delivery, accidents, fire or strikes, war, lockouts, or any other causes beyond its control.

7. Orders and Schedules

The Company does not accept verbal orders or instructions. All orders from customer or their agents must be received by fax, email or by post before they will be accepted and processed.

8. Defective Products

Free replacement will be made by the Company of any product which it agrees is defective, if returned within twelve months from the date of despatch from the Company. No liability for expenses incurred by customers or any consequential damage arising from such defects can be accepted by the Company.

9. Return of Goods

The return of any goods properly supplied will not be accepted unless the Company's authority has been previously agreed in writing and an address for returned goods given. Notification of such return must be in writing within 24 hours of receipt of the goods. The Buyer accepts and understands that the issuing of orders or contracts to the Company implies full agreement with the above terms and conditions.

10. Cancellations

Cancellation will only be accepted if agreed in writing. Any order cancelled within 48 hours of placement will be subject to a 5% administration charge of nett order value (€ 229 minimum). Beyond this point a cancellation charge of between 50% and full order value will be levied dependent upon the stage of production.

11. Delayed orders

Orders delayed within 2 weeks of the delivery week may be subject to a storage charge. This will be charged at a rate of €10+vat per pallet (or part of) per week (or part of). Invoice for the order will be sent to the client on the original delivery date. Invoicing for the storage to be on a 4-weekly basis, starting on the week the order was originally due out.

ALL PRICING QUOTED IS EX WORKS.

All products will be crated if they do not fit on a standard Euro pallet. Charges may apply.

Please allow 5 working days for delivery to European mainland.

The purchaser is responsible for any applicable import duty.

Please note:

1. Delivery is defined as a non-timed tailboard delivery to warehouse for client to offload between 0900 and 1700 hrs Monday to Friday excluding public holidays.
 2. Upon request timed deliveries and installation services are available subject to sufficient notice and at an extra cost.
 3. If requested New Design Group can provide "export" packaging for which additional charges may apply subject to the level of protection required.
 4. Responsibility for ensuring suitable access for delivery & installation is taken by customer.
 5. For further details on any of the above please contact your Customer Service operative.
-