



PLATFORM
FOR
FURNITURE





SDC_lab is furniture platform specialised in the production of soft coating on flexible elements such as foam.

Our expertise makes us a strong partner in customized projects, regardless of finishing or materials used.

Starting from the mind of an architect to the finished product on the floor. We're able to guide you along these steps.

Because of the expertise SDC_lab is the privileged partner for producing and commercializing products under the QUINZE & MILAN™ label

This pricelist is a guideline through the collection items and is also a base document for the first steps towards customizing.

Contact us for more information!

FOR YOUR CONVENIENCE

3	COATING FOAMSKIN COLOR SWATCHES
5	IMPORTANT NOTES ON THE PRICELIST
7	FINISHING SPECIFICATIONS

COLLECTIONS & SPECIFICATIONS

page	collection	design		
10	ACA ALLA - NEW PRODUCT 2022		92	QUARTZ
20	AIRBENCH		94	RONDO
24	CAMPING		98	ROOM 26
26	CLUB		100	ROUND CAKE
30	DAI		102	RPBW
34	DOK		106	SCONE
36	DEER		110	SEATTLE CROSS
38	GALETTE		112	SHAPES & CURVES
40	GAP		118	SKEW
44	FRAME		120	SLING - NEW PRODUCT 2022
46	INFINITY		126	SQUARES
50	LEAF BENCH		128	STRAIGHTS
54	LEAN		130	STAIR SEAT
56	LITTLE MISS O		132	UDA
60	M2		134	CUSTOMIZATION
62	MATRASS		136	UPGRADES
64	NORA		137	SCREENPRINTING
76	OSAKA		138	POWER INTEGRATION
80	PENTAGON		139	MINIMIZE
82	PILOT		140	FEET & BASES
86	PODIUM SEAT		141	OUTDOOR
88	PRIMARY		142	TERMS & CONDITIONS OF SALE



COLOUR SWATCHES FOR FOAMSKIN COATING QMFOAM / QMPLUS / QMTEX

Based on our technology we will match the indicated NCS, PANTONE and RAL colors as precise as possible. Minimum color differences for every production batch are unavoidable. You may demand us to produce a sample first, at the cost of €150,- (shipping included) per sample

Of course "WE LOVE COLOR", but just be aware that not all people appreciate color. our products need cleaning and respect from people. Lighter colours need more cleaning and more caution than darker colors; This is why we split up our range into "contractsafe" colors and the rest of our range. Up to your choice!

CONTRACT SAFE COLOURS

THESE PRINTED COLORS ARE ONLY AS A REFERENCE TO THE REAL COLOR, THEY ARE NOT THE EXACT COLORS. CHECK YOUR SAMPLES FOR REAL COLORS

05.Dark purple

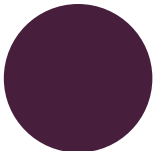

NCS: S7020R30B

06.Purple

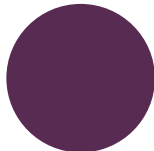

NCS: S6030R40B

08.Raspberry

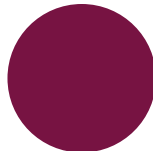

NCS: S4050R20B

14.Black

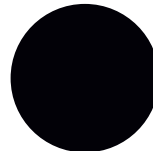

RAL: 9005

17.Anthracite

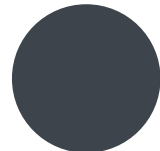

RAL: 7024

16.Red



RAL: 3020

36.Evening

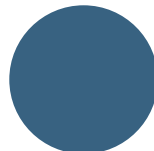

NCS: S5030R90B

35.Blue clair

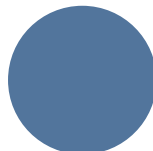

NCS: S3065R90B

41.Army



NCS: S7010G50Y

40.Pinetree

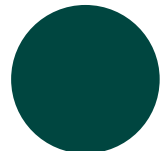

NCS: S7020B70G

12.Ochre



NCS: S3560Y20R

33.Moutarde

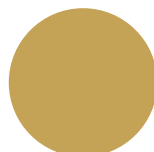

NCS: S4050Y

42.Steel blue

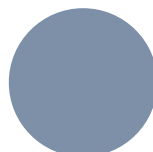

NCS: S3020R90B

07.Magenta

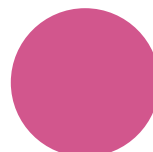

NCS: S1070R20B

COLOURS WITH CARE

THESE PRINTED COLORS ARE ONLY AS A REFERENCE TO THE REAL COLOR, THEY ARE NOT THE EXACT COLORS. CHECK YOUR SAMPLES FOR REAL COLORS

18.White



RAL: 9016

28.Cream



RAL: 9001

39.Silver



NCS: S2505R

09.Sky blue



NCS: S1060B

37.Turquoise

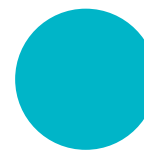

NCS: S1050B30G

44.Flamingo

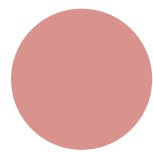

NCS: S2030R

38.Pastel green



NCS: S0540G50Y

10.Lime green



NCS: S1075G50Y

23.Chartreuse



NCS: S1080G30Y

43.Gold



NCS: S3060Y10R

45.Merengue



NCS: S0505Y50R

02.Sand

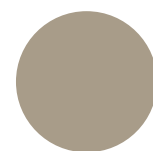

NCS: S4010Y10R

24.Orange



RAL: 2000

34.Fiesta



NCS: S0585Y70R

26.Fire



RAL: 2002

25.Yellow



NCS: S0580Y

32.Jaune pastel

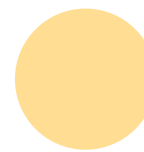

NCS: S0540Y

03.Taupe



NCS: S6010Y10R

IMPORTANT REMARKS



THE PRICES ARE CALCULATED WITH THE IDEA THAT THAT EVERYTHING IS DONE IN ONE COLOR.
ONCE YOU REQUIRE AN ADDITIONAL COLOR WITHIN AN ORDER, YOU MUST ADD A COLOR CHANGE.
WE CHARGE A SMALL ADDITIONAL FEE IN THE FUTURE PER COLOR, TO BE APPLIED FROM THE SECOND COLOR.
THIS IS REGARDLESS OF THE NUMBER OF PIECES PER COLOR.
THE PRICES FOR THIS COLOR CHANGE IS MENTIONED AT THE END OF THE PRICE LIST.



DELIVERY CHARGES

Delivered free for all orders with a value of > 900 euros
For all orders with a value < 900 euros, a fixed amount of will be charged for ordering costs.

Transport damages

Please note that in case you receive visual damaged goods you have to mark this clearly on the delivery sheet of the forwarder. It's imperative that you send a copy of this immediately to SDC email to info@sdclab.be.
If you fail to provide the delivery note with your remarks, we reject all transport claims.

Changing orders

Please note that changes of size and quality are only possible after approval of our internal sales office. These changes may lead to extra costs.

Cancellations

For all orders which are cancelled, 30% of the total amount will be charged.

Tolerances

We want to inform that all our qualities are subject to tolerances (weight, height, structure, colour, ...)

Claims

Claims of faulty goods must be made within 7 days after delivery. Please send your claim well specified, together with photos to your contacts at the office of SDC. If you have a problem with a product, we kindly ask you to prepare this immediately for return.
This will improve the speed of handling claims.
Don't use the faulty products without an approval of our office.

Technical details

All technical details can be provided on demand, or you can find them in the product catalogue or on our website.

Payment

ALL ORDERS WITH A VALUE > 10.000 EURO REQUIRE SPECIAL PAYMENT CONDITIONS.
IF NOT CLEARLY MARKED, THE FOLLOWING CONDITIONS WILL BE USED:
--> 50% WITH ORDER CONFIRMATION
(PRODUCTION WILL NOT BE INITIALIZED BEFORE THIS PAYMENT IS RECEIVED.)
--> 50% BEFORE SHIPMENT
(GOODS WILL NOT BE RELEASED BEFORE THIS PAYMENT)

Order for upholstered pieces and customized items

ALL ORDERS WITH A VALUE > 10.000 EURO REQUIRE SPECIAL PAYMENT CONDITIONS.
IF NOT CLEARLY MARKED, THE FOLLOWING CONDITIONS WILL BE USED:
--> 50% WITH ORDER CONFIRMATION
(PRODUCTION WILL NOT BE INITIALIZED BEFORE THIS PAYMENT IS RECEIVED.)
--> 50% BEFORE SHIPMENT
(GOODS WILL NOT BE RELEASED BEFORE THIS PAYMENT)

Finishing

The finishing is under continuous development for some types of furniture. But some pieces still have to be calculated. Check the sales office for more detailed information.
Please contact your agent for more information and help.

0 = product price in calculation - contact our office for pricing

IMPORTANT NOTE ON THE PRICELIST

Since 2017 we only quote NET prices, so [THIS PRICE LIST IS NET, VAT EXCLUDED.](#)

Another important notice:

THE PRICES ARE CALCULATED WITH THE IDEA THAT THAT EVERYTHING IS DONE IN ONE COLOR.

So once you require an additional color within an order, you must add a color change.

We charge a small additional fee in the future per color, to be applied from the second color.

This is regardless of the numbers of per color.

The price of this color change is indicated in the pricelist and on your quotation.

If we do not know the number of colors at the time of the quote, we will calculate 1 color change for the time being.

Don't find your color in our color swatch, no problemo!

We do custom colors at a small extra cost. This cost is not per item, but per color!

IMPORTANT:

if delivery is requested on site, thank you to do the necessary to provide a responsible person who can receive the goods.

SDC can not be held responsible for the delivery schedules of the carrier and any delays and can not accept any compensation on this subject.

The best is to request delivery in a warehouse that can receive the goods in mint conditions.

Additional charges may apply for all deliveries by truck with a tail lift.

.....
Colors - Color QM range - color

.....
colors - color custom NCS/RAL - color



PLATFORM
FOR
FURNITURE





QM FOAMSKIN™ foamcoating

QM Foam foamcoating refers to the result of a chemical reaction between the polyurethane foam shape and different layers, with different compositions, sprayed on to it. This results in a highly flexible coating to be compared to your skin.



QM PLUS™ foamcoating

QM Plus refers to the result of a chemical reaction between the polyurethane foam shape and different layers, with different compositions, sprayed onto it. The QM PLUS finishing has 2 layers of the foamcoating which results in a surface which has stronger resistance.



QM TEX™ texcoating

QM TEX is a coating applied to textiles. The result is a stiff and strong material, very durable, virtually tearproof and easy to clean. The interest of this innovation is to meet the growing need of invulnerability associated with furniture solutions, walls, reception desks, while maintaining a soft touch. Like most of our products, Skintex allows a wide range of possibilities for customization: wide choice of colors, shapes, patterns, as well as the possibility to combine different materials with diverse mediums and kinds of coating, maintaining our known quality standards for the final product. This finishing is one of our own developments.



UPHOLSTERED



C.O.M. Upholstered in Client's Own Materials (fabric or leather)
For specific quantities, please contact us. / more info: Terms & Conditions of Sale

CAT.01 Upholstered in fabrics indicated by SDC lab as price category 01

CAT.02 Upholstered in fabrics indicated by SDC lab as price category 02



CURRENT COLLECTIONS

This is just a selection of fabrics we can supply

- CAT.01 Step by Gabriel
Remix by Kvadrat
Stamskin-Top
Silvertex
Sunbrella by Dickson
- CAT.02 Camira Blazer
Topia by Rohi
Novum by Rohi
Divina, Divina Melange by Kvadrat



VESCOM



Gabriel®

Serge Ferrari

kvadrat



Founders of the Quinze & Milan label Arne Quinze & Yves Milan

0 = product price in calculation - contact our office for pricing

*Quinze & Milan*TM

INTRODUCING QUINZE & MILAN

Quinze & Milan is not a typical designer furniture label .

Quinze & MilanTM Collections go beyond furniture design.

Our products prompt you to spin tales, to dream and to shape a reality all your own.

Quinze & Milan is a platform, a label with an enormously fascinating synergy, that features the work of designers.

We like to push the boundaries – our own and those of the people around us.

In our cosmos, boundaries exist only to be shifted...

ACA ALLA

DESIGN Bjorn Vande Vijvere

2021



0 = product price in calculation - contact our office for pricing

ACA ALLA

DESIGN Björn Vande Vijvere

2021



> Acà Allà

> Design by Björn Vande Vijvere, 2020

> This design started with the idea of building a piece of furniture that adapts to the needs of the user. It was important to me to design a system that was able to 'grow' by adding more features to the base parts. I love it when someone else can use my work as the basis for his own creativity. Therefore the design has been kept very clean, simple and very modular. One could form a long swirling line with my design, a circle for a more intimate feeling or scatter it around throughout the space. Hence the name "acà allà", two words often used in Latin America: Somewhere over here.. Somewhere over there.. I am very curious to see what people will come up with when they start using it...



 **acà allà**
here, there and everywhere

0 = product price in calculation - contact our office for pricing

ACA ALLA SEAT 60

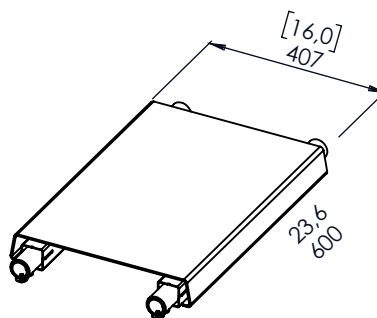

ACA ALLA SEAT 120

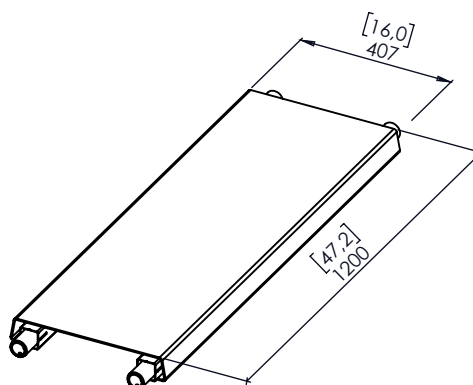

ACA ALLA SEAT 180

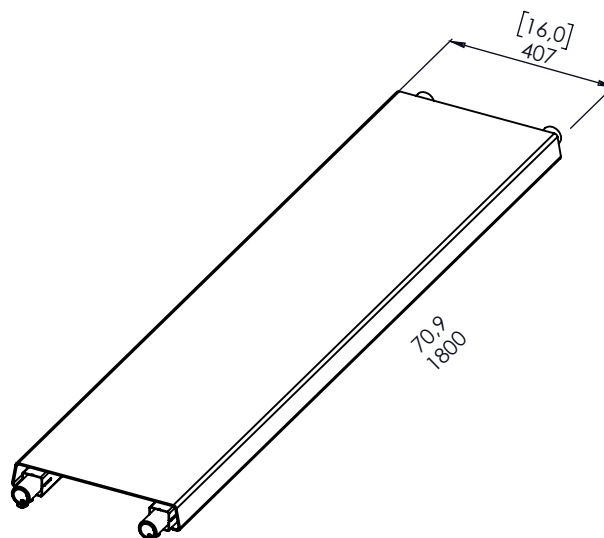

0 = product price in calculation - contact our office for pricing

ACA ALLA

DESIGN Bjorn Vande Vijvere
2021



ACA ALLA LEG

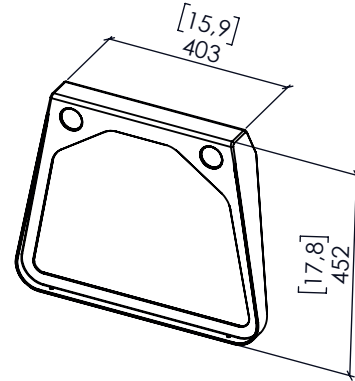

ACA ALLA TWIST

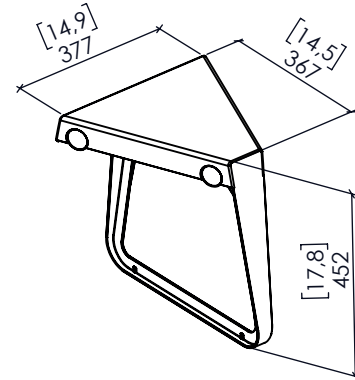

ACA ALLA TABLE

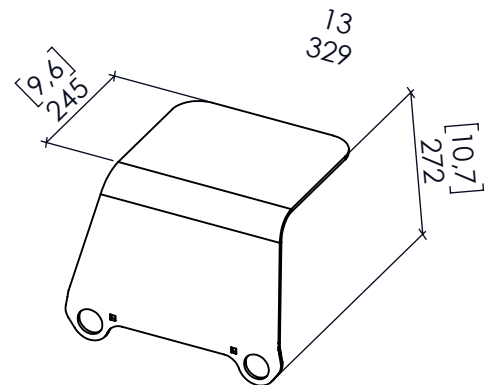

price per piece for loose elements

Acà allà bench 60
Acà allà bench 120
Acà allà bench 180
Acà allà leg
Acà allà twist
Acà allà seat 60
Acà allà seat 120
Acà allà seat 180
Acà allà table

0 = product price in calculation - contact our office for pricing

ACA ALLA

DESIGN Bjorn Vande Vijvere

2021



Acà Allà seating system consists of some basic parts, which can be connected in a modular way to meet the needs in your setting.

We have 1 basic straight leg and a twist leg. This 'Twist leg' allows you to change the direction of your bench.

The next pages contain more information on possible settings.

price per piece for proposed configurations

Acà Allà configuration 1

Acà Allà configuration 2

Acà Allà configuration 3

Acà Allà configuration 4

Acà Allà configuration 5

Acà Allà configuration 6

Acà Allà configuration 7

Acà Allà configuration 8



0 = product price in calculation - contact our office for pricing

ACA ALLA

DESIGN Bjorn Vande Vijvere

2021

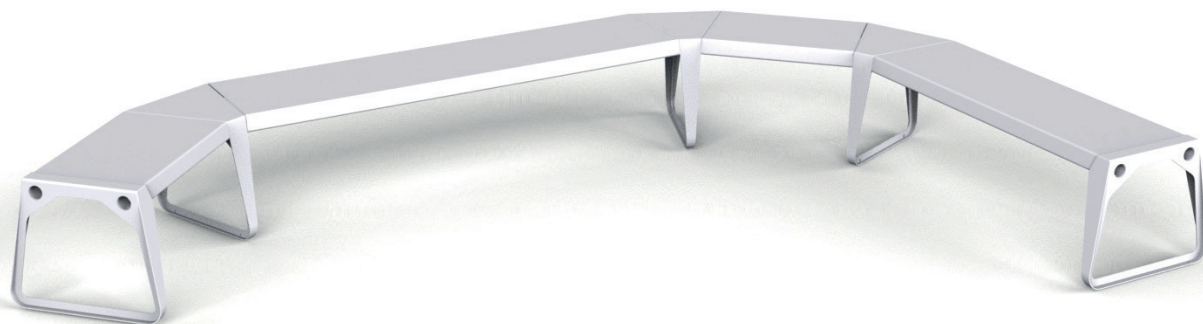

ACA ALLA configuration 1

This configuration is built with the following parts
2 legs, 3 twist legs, 2 seat 60, 1 seat 120, 1 seat 180



ACA ALLA configuration 2

This configuration is built with the following parts
2 legs, 2 twist legs, 3 seat 60

0 = product price in calculation - contact our office for pricing

ACA ALLA

DESIGN Bjorn Vande Vijvere

2021



ACA ALLA configuration 3

This configuration is built with the following parts

2 legs, 1 twist legs, 1 seat 60, 1 seat 120



ACA ALLA configuration 4

This configuration is built with the following parts

2 legs, 1 seat 60, 1 table

0 = product price in calculation - contact our office for pricing

ACA ALLA

DESIGN Bjorn Vande Vijvere
2021



ACA ALLA configuration 5

This configuration is built with the following parts
2 legs, 1 seat 120



ACA ALLA configuration 6

This configuration is built with the following parts
2 legs, 2 leg twist, 2 seat 60, 1 seat 180

0 = product price in calculation - contact our office for pricing

ACA ALLA

DESIGN Bjorn Vande Vijvere

2021



ACA ALLA configuration 7

This configuration is built with the following parts

2 legs, 2 leg twist, 2 seat 60, 1 seat 180



ACA ALLA configuration 8

This configuration is built with the following parts

2 legs, 1 seat 180

0 = product price in calculation - contact our office for pricing

ACA ALLA

DESIGN Bjorn Vande Vijvere

2021



0 = product price in calculation - contact our office for pricing



0 = product price in calculation - contact our office for pricing



As an ultimate communication tool, an bench setting creates a landscape of human interaction. Available in variable shapes — crosses, rectangles or meanders — these benches are multifunctional and modular, offering endless combination possibilities. By accident people meet each other as they take place on the bench and immediately look into the opponents eyes. Staying silent is no longer an option as it burdens you with an unpleasant feeling.

Verbal and social interaction, giving new energy and impulses, becomes the only standard in community life.

On the Single and Double bench, people receive glimpses of each other and start communicating out of curiosity. People get interwoven by interaction. They are forced to sit in an open atmosphere and cocooning is very much a memory from the past. Due to the philosophy behind them, benches are the ideal communication tools in public areas; musea, exhibitions, libraries, lounges, airports, waiting areas,...

Custom color or sizes are available upon request.

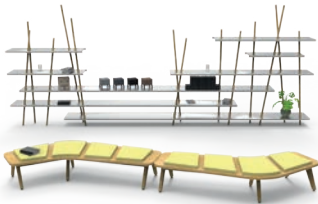

ABENCH SINGLE 01

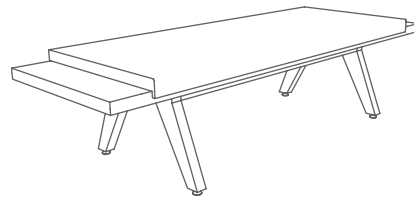
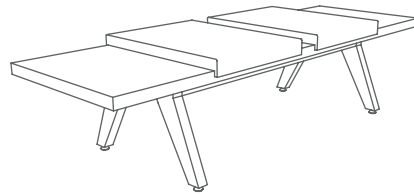

- A'bench - 01 Base - Oak fineer
- A'bench - 01 single seat integration - QM Foam skin
- A'bench - 01 single seat integration - QM Plus foamskin double
- A'bench - 01 single seat integration - QM Tex foamskin tex
- A'bench - 01 single seat integration - fabric CAT 1
- A'bench - 01 single seat integration - fabric CAT 2
- A'bench - 01 single seat integration - fabric CAT 0/COM
- A'bench - 01 double seat integration - QM Foam skin
- A'bench - 01 double seat integration - QM Plus foamskin double
- A'bench - 01 double seat integration - QM Tex foamskin tex
- A'bench - 01 double seat integration - fabric CAT 1
- A'bench - 01 double seat integration - fabric CAT 2
- A'bench - 01 double seat integration - fabric CAT 0/COM

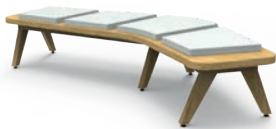

ABENCH SMALL BOOMERANG

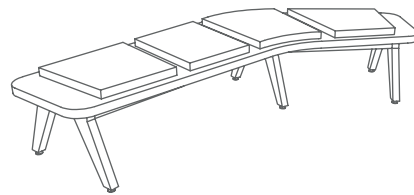

- A'bench - Small Boomerang incl. Cushions - QM Foam skin
- A'bench - Small Boomerang incl. Cushions - QM Plus foamskin double
- A'bench - Small Boomerang incl. Cushions - QM Tex foamskin tex
- A'bench - Small Boomerang incl. Cushions - fabric CAT 1
- A'bench - Small Boomerang incl. Cushions - fabric CAT 2
- A'bench - Small Boomerang incl. Cushions - fabric CAT 0/COM

All other models and variations of our Airbench, such as Airbench 02 and small cross are available on request. Please contact our sales office for the right pricing.

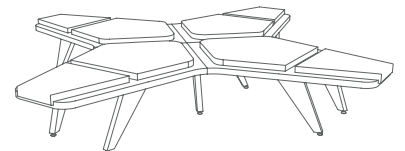
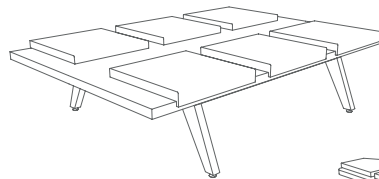
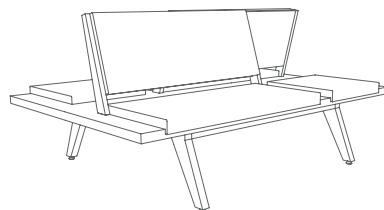
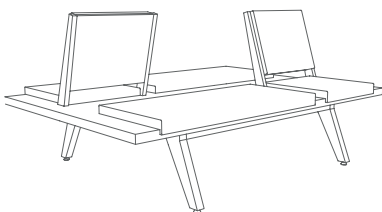

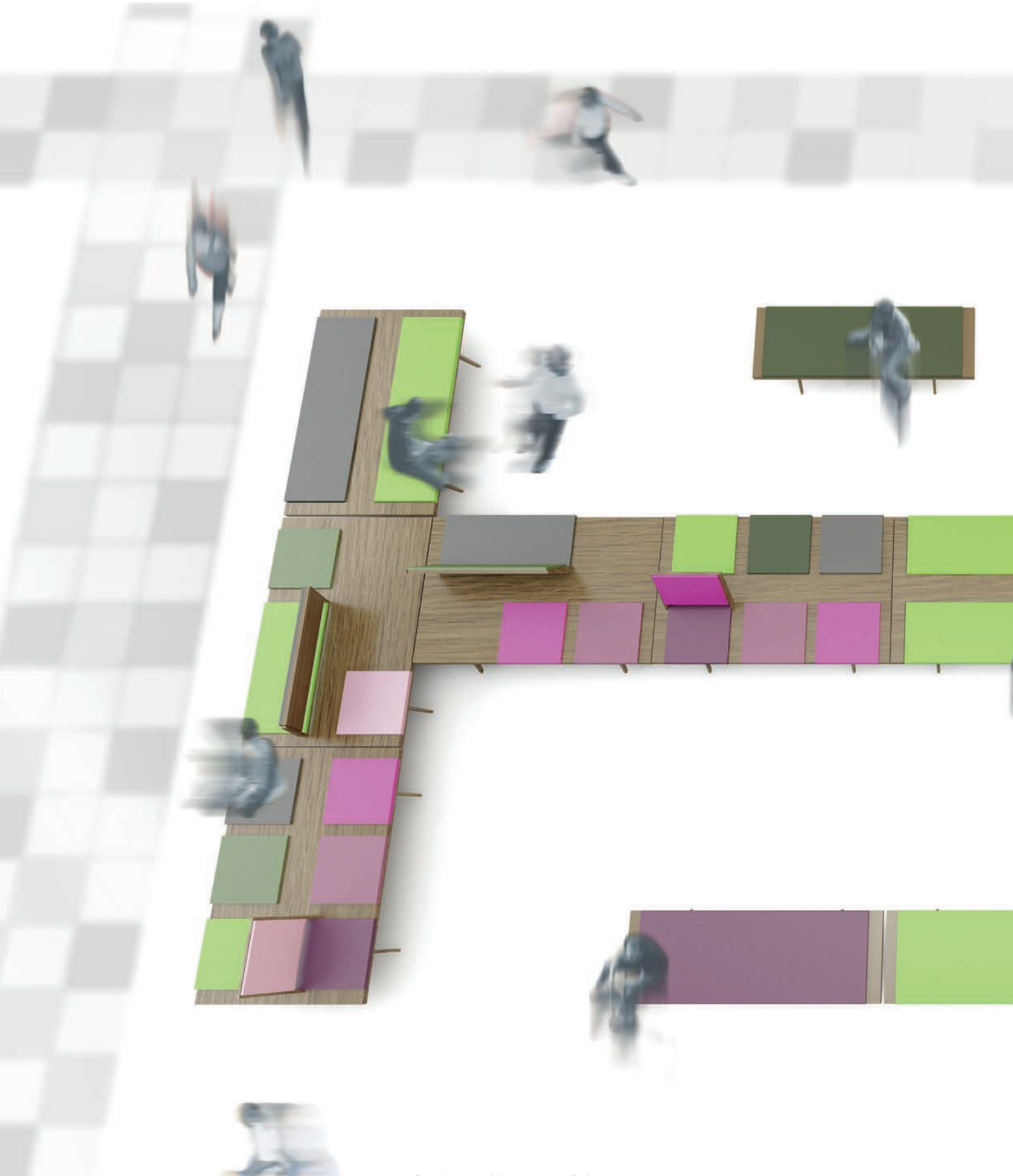

0 = product price in calculation - contact our office for pricing



0 = product price in calculation - contact our office for pricing



0 = product price in calculation - contact our office for pricing

ROOM 26 has a look that fuses the familiar and the timeless with 'something different', offering an extensive range of products that can transform an interior into a space that shouts '26' or, when used sparingly, can conjure up a room that barely whispers the word.

Key to the collection is oak, a material playfully combined with fabric, leather or Foamskin cushions.



CAMPING table 220
INNER or OUTER LEGS

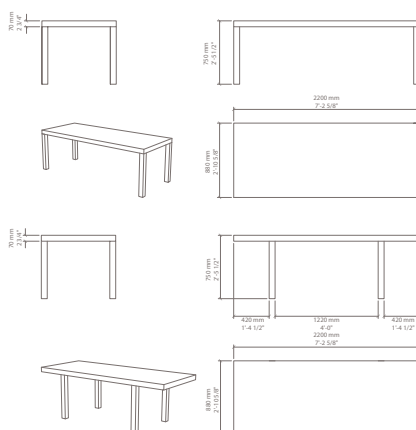

Camping Table 220 Massive Oak

CAMPING table 250
INNER or OUTER LEGS

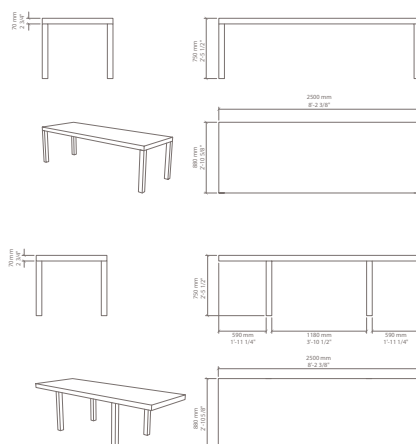

Camping Table 250 Massive oak

0 = product price in calculation - contact our office for pricing





Simple, plain, bold: three words that describe the body language of CLUB, a design that seems to say: 'If the basics are right, who needs ornament?' Made from our proprietary QM FOAM™, CLUB is happy indoors and out.

After many successful years, CLUB is now enhanced with a series of new shapes and solutions. Especially the loose cushions are important additions. The seating cushions are made of a combination of memory foam and wadding to create extreme softness and comfort in just a few centimeters of thickness. The back cushions are made of goose down. All loose cushions have removable covers.

The new lateral units standard come with a straight back on the inside. But versions with an inclined inside back are possible upon request. Drawings refer to the left version.

CLUB is also available upholstered in leather and fabric.
Custom color or sizes are available upon request.

CLUB SOFA 01

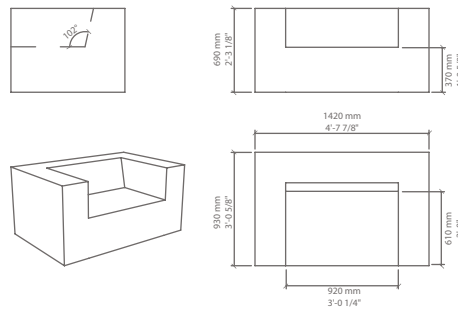
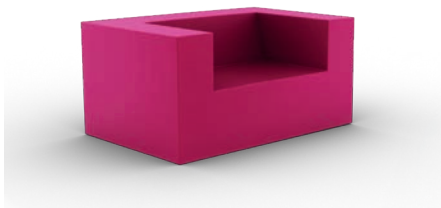

- Club sofa 01 QM Foam skin
- Club sofa 01 QM Plus foamskin double
- Club sofa 01 QM Tex foamskin Tex
- Club sofa 01 QM CAT 1
- Club sofa 01 QM CAT 2
- Club sofa 01 QM CAT 0/COM

CLUB OTTOMAN 01

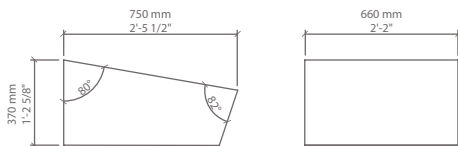

- Club ottoman 01 QM Foam skin
- Club ottoman 01 QM Plus foamskin double
- Club ottoman 01 QM Tex foamskin Tex
- Club ottoman 01 QM CAT 1
- Club ottoman 01 QM CAT 2
- Club ottoman 01 QM CAT 0/COM

CLUB SOFA 02

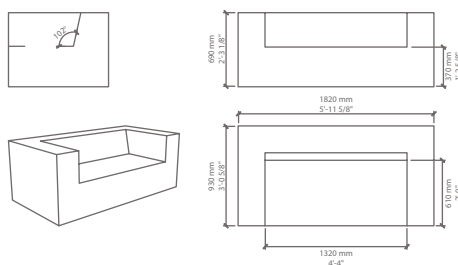

- Club sofa 02 QM Foam skin
- Club sofa 02 QM Plus foamskin double
- Club sofa 02 QM Tex foamskin Tex
- Club sofa 02 QM CAT 1
- Club sofa 02 QM CAT 2
- Club sofa 02 QM CAT 0/COM

CLUB OTTOMAN 02

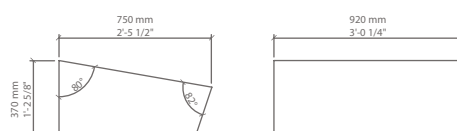

- Club ottoman 02 QM Foam skin
- Club ottoman 02 QM Plus foamskin double
- Club ottoman 02 QM Tex foamskin Tex
- Club ottoman 02 QM CAT 1
- Club ottoman 02 QM CAT 2
- Club ottoman 02 QM CAT 0/COM

0 = product price in calculation - contact our office for pricing

CLUB SOFA 03

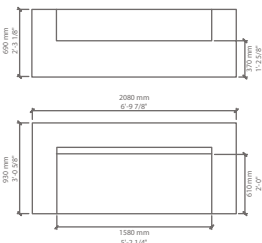
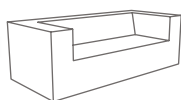

- Club sofa 03 QM Foam skin
- Club sofa 03 QM Plus foamskin double
- Club sofa 03 QM Tex foamskin
- Club sofa 03 QM CAT 1
- Club sofa 03 QM CAT 2
- Club sofa 03 QM CAT 0/COM

CLUB SOFA 04

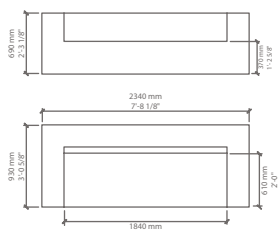
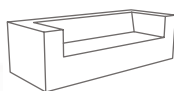

- Club sofa 04 QM Foam skin
- Club sofa 04 QM Plus foamskin double
- Club sofa 04 QM Tex foamskin Tex
- Club sofa 04 QM CAT 1
- Club sofa 04 QM CAT 2
- Club sofa 04 QM CAT 0/COM

CLUB SOFA 05

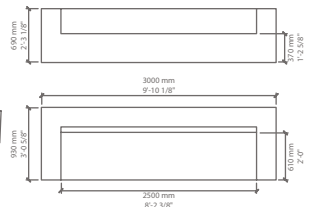
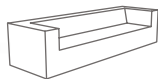

- Club sofa 05 QM Foam skin
- Club sofa 05 QM Plus foamskin double
- Club sofa 05 QM Tex foamskin Tex
- Club sofa 05 QM CAT 1
- Club sofa 05 QM CAT 2
- Club sofa 05 QM CAT 0/COM

CLUB POUF 01

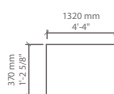
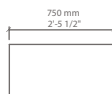

- Club pouf 01 QM Foam skin
- Club pouf 01 QM Plus foamskin double
- Club pouf 01 QM Tex foamskin Tex
- Club pouf 01 QM CAT 1
- Club pouf 01 QM CAT 2
- Club pouf 01 QM CAT 0/COM

CLUB POUF 02



- Club pouf 02 QM Foam skin
- Club pouf 02 QM Plus foamskin double
- Club pouf 02 QM Tex foamskin Tex
- Club pouf 02 QM CAT 1
- Club pouf 02 QM CAT 2
- Club pouf 02 QM CAT 0/COM

0 = product price in calculation - contact our office for pricing

CLUB SOFA 02 EXTENDED

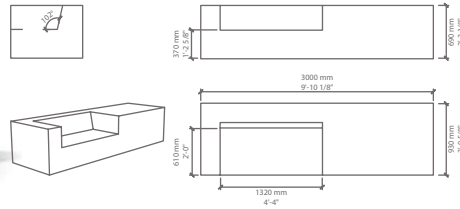

- Club sofa 02 extended QM Foam skin
- Club sofa 02 extended QM Plus foamskin double
- Club sofa 02 extended QM Tex foamskin Tex
- Club sofa 02 extended QM CAT 1
- Club sofa 02 extended QM CAT 2
- Club sofa 02 extended QM CAT 0/COM

CLUB SOFA 02 + 01 EXTENDED

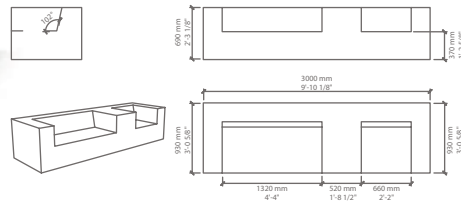

- Club sofa 02 + 01 extended QM Foam skin
- Club sofa 02 + 01 extended QM Plus foamskin double
- Club sofa 02 + 01 extended QM Tex foamskin Tex
- Club sofa 02 + 01 extended QM CAT 1
- Club sofa 02 + 01 extended QM CAT 2
- Club sofa 02 + 01 extended QM CAT 0/COM

CLUB LATERAL VARIATIONS

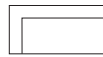

SOFA LATERAL 02

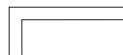

SOFA LATERAL 03



SOFA LATERAL 04

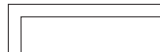

SOFA LATERAL 05

- Club sofa lateral 02 QM Foam skin
- Club sofa lateral 02 QM Plus foamskin double
- Club sofa lateral 02 QM Tex foamskin Tex
- Club sofa lateral 02 QM CAT 1
- Club sofa lateral 02 QM CAT 2
- Club sofa lateral 02 QM CAT 0/COM
- Club Lateral 03 QM Foam skin
- Club Lateral 03 QM Plus foamskin double
- Club Lateral 03 QM Tex foamskin Tex
- Club Lateral 03 QM CAT 1
- Club Lateral 03 QM CAT 2
- Club Lateral 03 QM CAT 0/COM
- Club sofa lateral 04 QM Foam skin
- Club sofa lateral 04 QM Plus foamskin double
- Club sofa lateral 04 QM Tex foamskin Tex
- Club sofa lateral 04 QM CAT 1
- Club sofa lateral 04 QM CAT 2
- Club sofa lateral 04 QM CAT 0/COM
- Club sofa lateral 05 QM Foam skin
- Club sofa lateral 05 QM Plus foamskin double
- Club sofa lateral 05 QM Tex foamskin Tex
- Club sofa lateral 05 QM CAT 1
- Club sofa lateral 05 QM CAT 2
- Club sofa lateral 05 QM CAT 0/COM

0 = product price in calculation - contact our office for pricing

DAI

DESIGN KAZUKO OKAMOTO

2009



Quinze & milan



0 = product price in calculation - contact our office for pricing

Kazuko Okamoto creates designs combining fun and function. Fun? A perfect cut out Dai Ottoman right out the Dai Sofa. Function? Extending the sofa with a table piece attached to the sofa. Put your laptop on your sofa! Put up your feet on the Ottoman! Recreation all in one piece of foam.

Drawings refer to the left version, the right version comes at the same price.

DAI SOFA is also available upholstered in leather and fabric.
Custom color or sizes are available upon request.

DAI SOFA 01

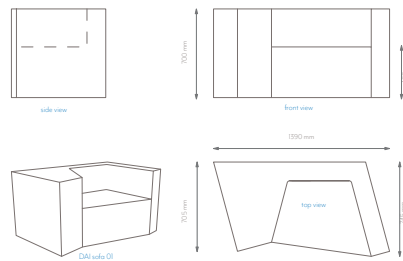
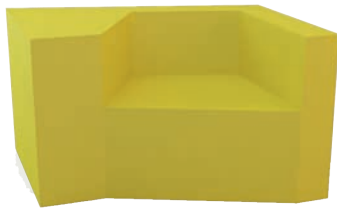

- Dai sofa 01 - QM Foam skin
- Dai sofa 01 - QM Plus foamskin double
- Dai sofa 01 - QM Tex foamskin Tex
- Dai sofa 01 - QM CAT 1
- Dai sofa 01 - QM CAT 2
- Dai sofa 01 - QM CAT 0/COM

*THE DRAWINGS REFER TO THE LEFT SIDE VERSION

DAI SOFA 01 angular backrest

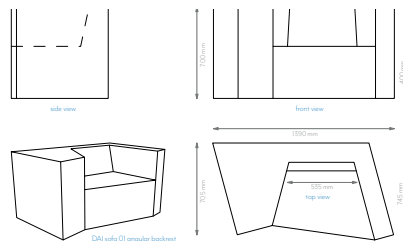

- Dai Sofa 01 angular backrest - QM Foam skin
- Dai Sofa 01 angular backrest - QM Plus foamskin double
- Dai Sofa 01 angular backrest - QM Tex foamskin Tex
- Dai Sofa 01 angular backrest - QM CAT 1
- Dai Sofa 01 angular backrest - QM CAT 2
- Dai Sofa 01 angular backrest - QM CAT 0/COM

DAI OTTOMAN

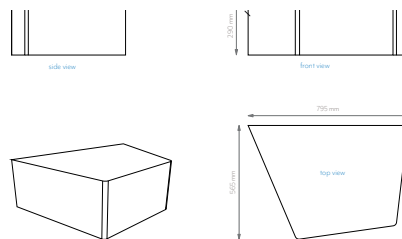

- Dai ottoman - QM Foam skin
- Dai ottoman - QM Plus foamskin double
- Dai ottoman - QM Tex foamskin Tex
- Dai ottoman - QM CAT 1
- Dai ottoman - QM CAT 2
- Dai ottoman - QM CAT 0/COM

DAI SOFA SOFA 02

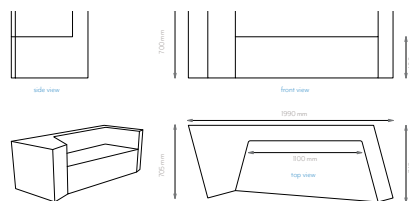

- Dai sofa 02 - QM Foam skin
- Dai sofa 02 - QM Plus foamskin double
- Dai sofa 02 - QM Tex foamskin Tex
- Dai sofa 02 - QM CAT 1
- Dai sofa 02 - QM CAT 2
- Dai sofa 02 - QM CAT 0/COM

0 = product price in calculation - contact our office for pricing



0 = product price in calculation - contact our office for pricing

DAI SOFA SOFA 03

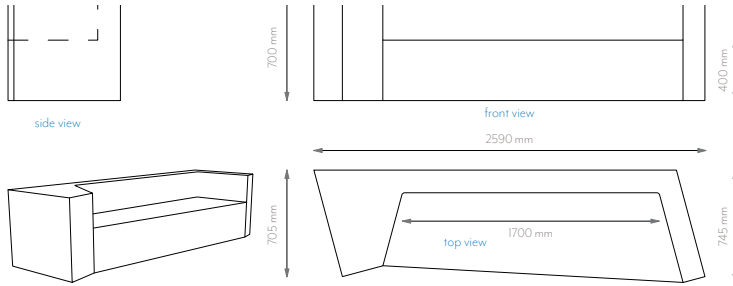

-
- Dai sofa 03 QM Foam skin
- Dai sofa 03 QM Plus foamskin double
- Dai sofa 03 QM Tex foamskin Tex
- Dai sofa 03 QM CAT 1
- Dai sofa 03 QM CAT 2
- Dai sofa 03 QM CAT 0/COM
-

DAI SOFA SOFA MIRROR

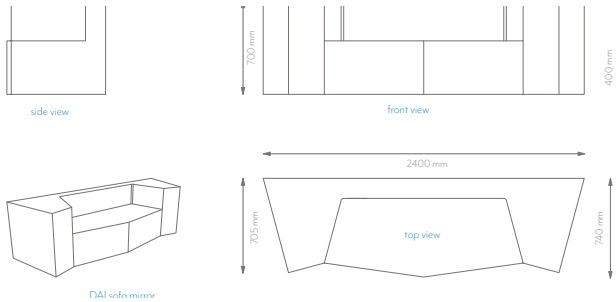
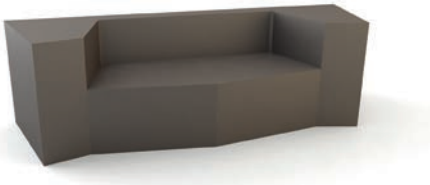

-
- Dai mirror QM Foam skin
- Dai mirror QM Plus foamskin double
- Dai mirror QM Tex foamskin Tex
- Dai mirror QM CAT 1
- Dai mirror QM CAT 2
- Dai mirror QM CAT 0/COM
-

DAI SOFA SOFA LATERAL

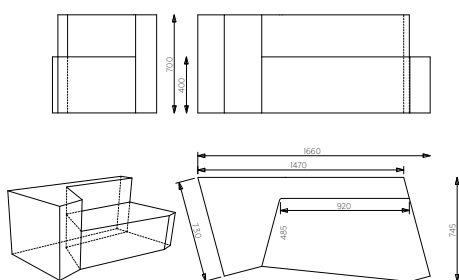

-
- Dai lateral QM Foam skin
- Dai lateral QM Plus foamskin double
- Dai lateral QM Tex foamskin Tex
- Dai lateral QM CAT 1
- Dai lateral QM CAT 2
- Dai lateral QM CAT 0/COM
-

0 = product price in calculation - contact our office for pricing

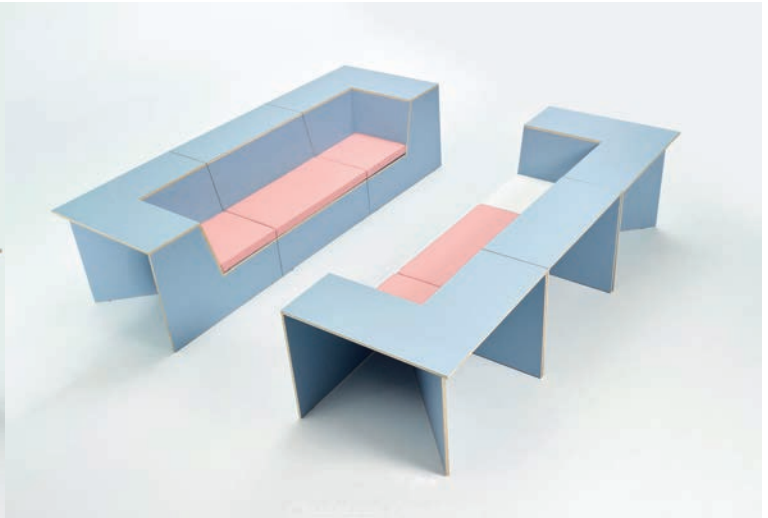

DOK furniture office system
 Why choosing between a table or seat, when you can combine both?
 DOK creates instant functionality where needed, in endless combinations.
 This seating and work space makes any environment productive, valuable and inspiring.
 Available in different materials for indoor & outdoor.
<http://www.fiveam.be/work/dok/>

DOK CUSHIONS are also available upholstered in leather and fabric.
 Custom color or sizes are available upon request.



DOK CORNER

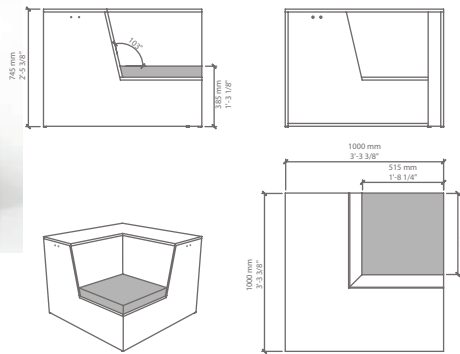

DOK IN corner Multiplex birch

DOK IN corner Polyrey Finishing

DOK STRAIGHT

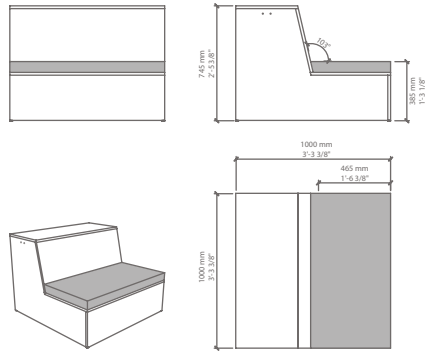

DOK IN straight Multiplex birch

DOK IN straight Polyrey Finishing

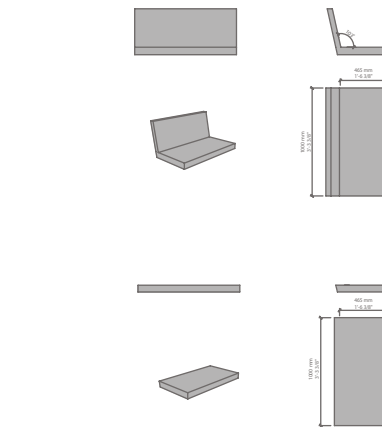

DOK Cushion straight no back QM Foam skin

DOK Cushion straight no back QM Plus foamskin double

DOK Cushion straight no back QM Tex foamskin Tex

DOK Cushion straight no back QM CAT 1

DOK Cushion straight no back QM CAT 2

DOK Cushion straight no back QM CAT 0 / COM

DOK Cushion corner no back QM Foam skin

DOK Cushion corner no back QM Plus foamskin double

DOK Cushion corner no back QM Tex foamskin Tex

DOK Cushion corner no back QM CAT 1

DOK Cushion corner no back QM CAT 2

DOK Cushion corner no back QM CAT 0 / COM

DOK Cushion straight with back QM Foam skin

DOK Cushion straight with back QM Plus foamskin double

DOK Cushion corner with back QM Foam skin

DOK Cushion corner with back QM Plus foamskin double



0 = product price in calculation - contact our office for pricing

DEER

DESIGN SAQ

2005



Quinze & milan

An informal waiting system, inspired by the forms of nature.

Three modules with different geometric forms can be composed in countless ways and form islands of seats designed for large public spaces and of a destructured home.

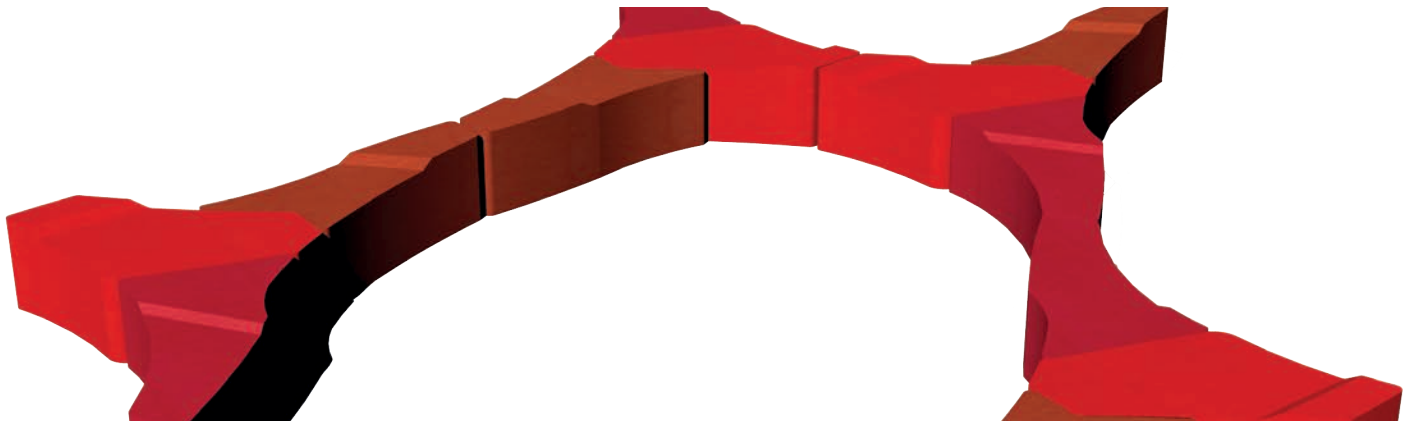

DEER 01

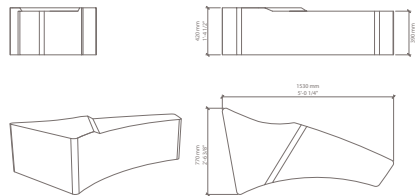

DEER 02

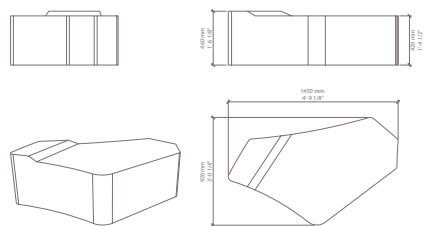

DEER 03

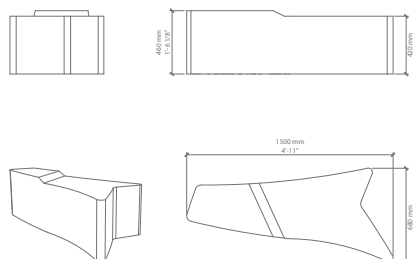

-
- Deer Set QM Foam skin
-
- Deer Set QM Plus foamskin double
-
- Deer Set QM CAT 1
-
- Deer Set QM CAT 2
-
- Deer Set QM CAT 0/COM
-

-
- Deer 1 QM Foam skin
-
- Deer 1 QM Plus foamskin double
-
- Deer 1 QM CAT 1
-
- Deer 1 QM CAT 2
-
- Deer 1 QM CAT 0/COM
-

-
- Deer 2 QM Foam skin
-
- Deer 2 QM Plus foamskin double
-
- Deer 2 QM CAT 1
-
- Deer 2 QM CAT 2
-
- Deer 2 QM CAT 0/COM
-

-
- Deer 3 QM Foam skin
-
- Deer 3 QM Plus foamskin double
-
- Deer 3 QM CAT 1
-
- Deer 3 QM CAT 2
-
- Deer 3 QM CAT 0/COM
-

0 = product price in calculation - contact our office for pricing



GALETTE

DESIGN SDC lab

2016



GALETTE

a simple square, rectangular or round cushion with a minimum thickness of 6cm, provides the ideal color swatch for your projects.

Contact our sales office for more pricing options.

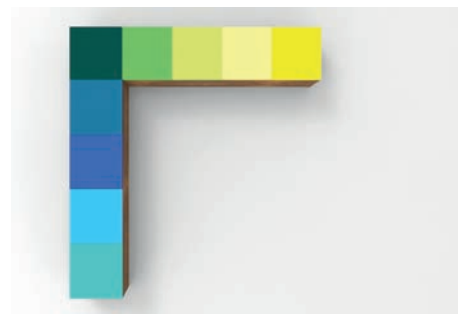

GALETTE ROUND

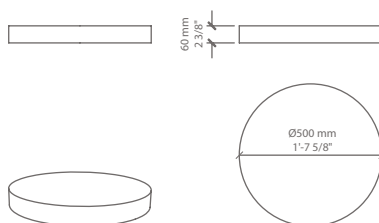

Galettes - round diam 50cm x H6cm - QM Foam skin

Galettes - round diam 50cm x H6cm - QM Plus foamskin double

Galettes - round diam 50cm x H6cm - QM Tex foamskin Tex

Galettes - round diam 50cm x H6cm - fabric CAT 1

Galettes - round diam 50cm x H6cm - fabric CAT 2

Galettes - round diam 50cm x H6cm - fabric CAT 0/COM

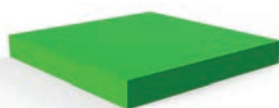

GALETTE SQUARE

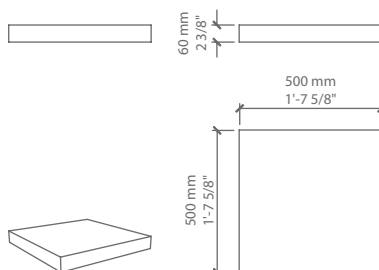

Galettes - square 50cm x H6cm - QM Foam skin

Galettes - square 50cm x H6cm - QM Plus foamskin double

Galettes - square 50cm x H6cm - QM Tex foamskin Tex

Galettes - square 50cm x H6cm - fabric CAT 1

Galettes - square 50cm x H6cm - fabric CAT 2

Galettes - square 50cm x H6cm - fabric CAT 0/COM

0 = product price in calculation - contact our office for pricing

GAP

DESIGN Kazuko Okamoto

2018



✓ product price in consultation | contact our service for pricing



GAP SEAT

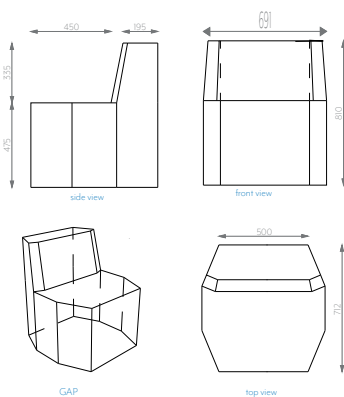

- GAP - seat - QM Foam skin
- GAP - seat - QM Plus foamskin double

GAP POUF

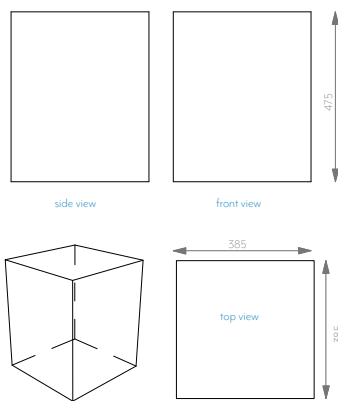

- GAP - pouf - QM Foam skin
- GAP - pouf - QM Plus foamskin double

GAP TRIANGLE

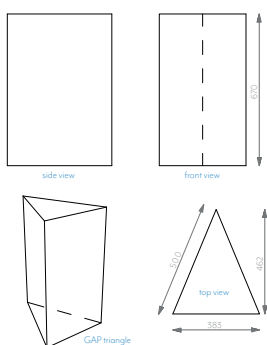

- Gap Triangle pouf QM Foam skin
- Gap Triangle pouf QM Plus foamskin double

0 = product price in calculation - contact our office for pricing

GAP

DESIGN Kazuko Okamoto

2018

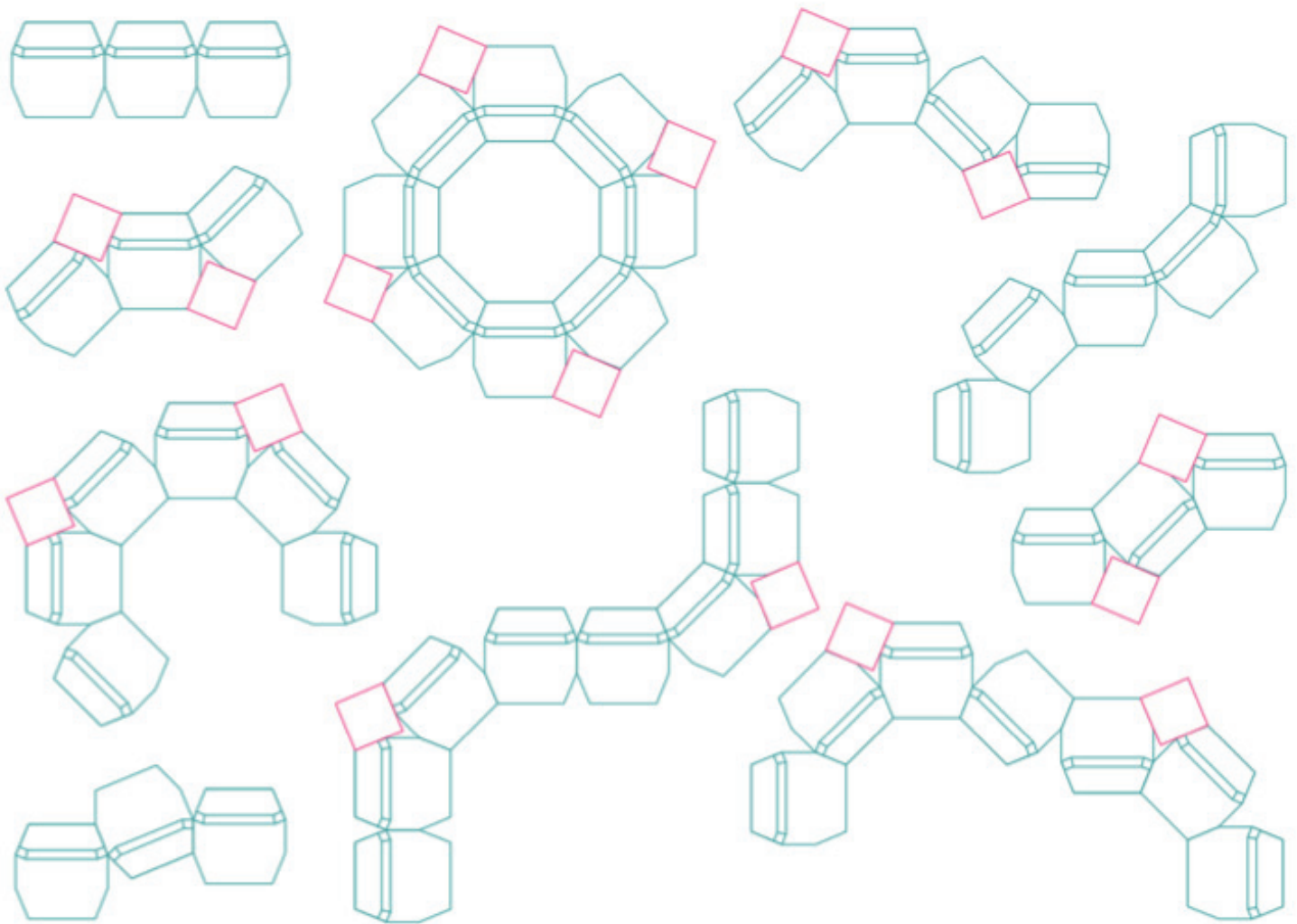
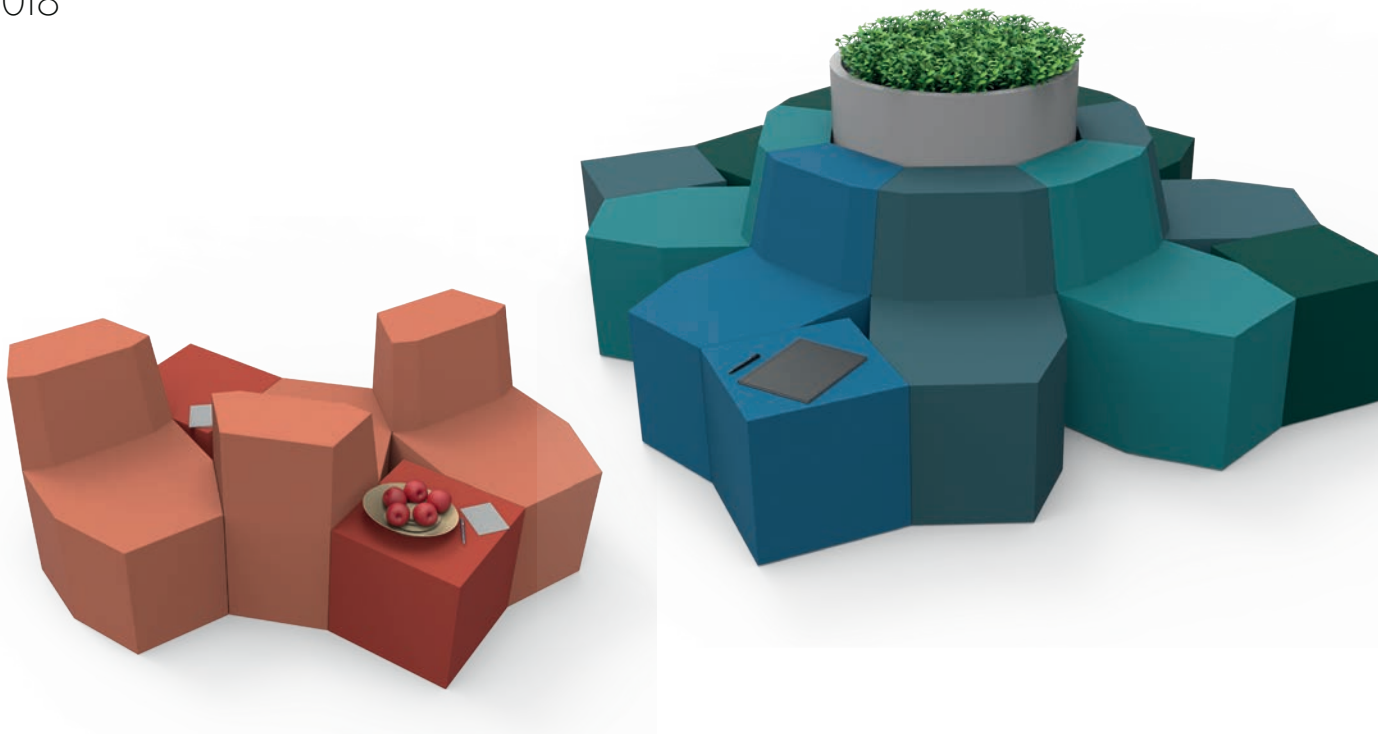

0 = product price in calculation - contact our office for pricing

FRAME

DESIGN QUINZE & MILAN

2004



Quinze & milan



0 = product price in calculation - contact our office for pricing

FRAME

DESIGN QUINZE & MILAN

2004



Quinze & milan

Part of moving forward is looking backward. FRAME is a 21st-century remake of the old-fashioned armchair.

Familiar and fascinating at the same time, FRAME combines a stationary tubular-metal frame with Foamskin or upholstered in leather or fabric all for matchless comfort.

Its fresh, distinctive look complements any contemporary setting, while blending with equal ease into a more classic environment. FRAME includes one and two seater settees with and without armrests.



FRAME ARM 75

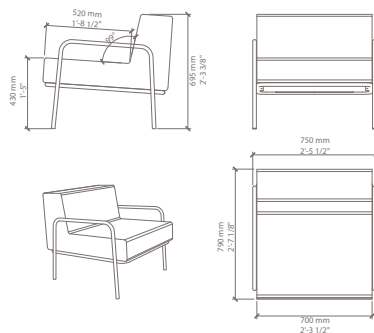

-
-
-
-
-
-
-
-
-
-

FRAME ARM 100

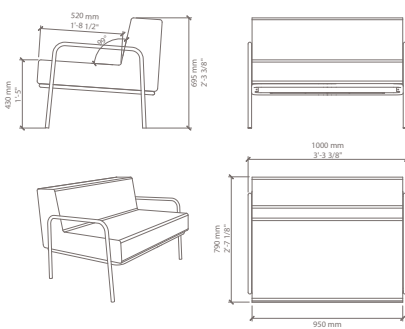

-
-
-
-
-
-
-
-
-
-

FRAME 100

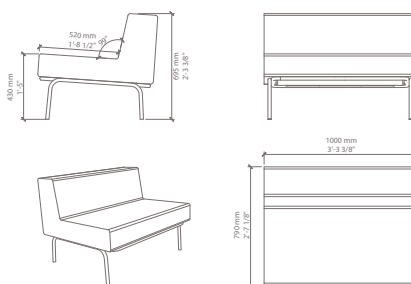

-
-
-
-
-
-
-
-
-
-

0 = product price in calculation - contact our office for pricing



0 = product price in calculation - contact our office for pricing

A collection of seating elements that can be combined into... that's right... INFINITY. These pieces are perfect for large public spaces – lounges, lobbies, waiting rooms – or for any spot that will benefit from being divided and subdivided ad infinitum. Those who live in less spacious quarters can stack INFINITY modules to make partition walls. The possibilities are infinite.

INFINITY is also available upholstered in leather and fabric.
Custom color or sizes are available upon request.



INFINITY STRAIGHT S

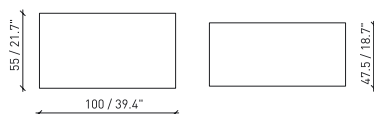

- Infinity Straight S QM Foam skin
- Infinity Straight S QM Plus foamskin double
- Infinity Straight S QM Tex foamskin Tex
- Infinity Straight S QM CAT 1
- Infinity Straight S QM CAT 2
- Infinity Straight S QM CAT 0/COM



INFINITY STRAIGHT L

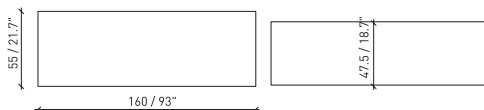

- Infinity Straight L QM Foam skin
- Infinity Straight L QM Plus foamskin double
- Infinity Straight L QM Tex foamskin Tex
- Infinity Straight L QM CAT 1
- Infinity Straight L QM CAT 2
- Infinity Straight L QM CAT 0/COM



INFINITY STRAIGHT XL

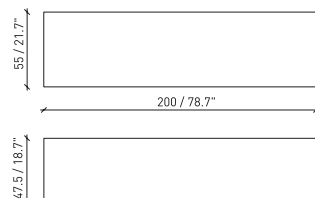

- Infinity Straight XL QM Foam skin
- Infinity Straight XL QM Plus foamskin double
- Infinity Straight XL QM Tex foamskin Tex
- Infinity Straight XL QM CAT 1
- Infinity Straight XL QM CAT 2
- Infinity Straight XL QM CAT 0/COM

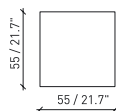

- Infinity Cube S QM Foam skin
- Infinity Cube S QM Plus foamskin double
- Infinity Cube S QM Tex foamskin Tex
- Infinity Cube S QM CAT 1
- Infinity Cube S QM CAT 2
- Infinity Cube S QM CAT 0/COM



INFINITY CUBE XL

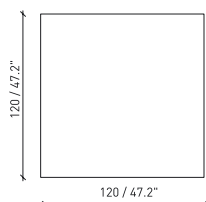

- Infinity Cube XL QM Foam skin
- Infinity Cube XL QM Plus foamskin double
- Infinity Cube XL QM Tex foamskin Tex
- Infinity Cube XL QM CAT 1
- Infinity Cube XL QM CAT 2
- Infinity Cube XL QM CAT 0/COM

0 = product price in calculation - contact our office for pricing

INFINITY DESIGN SAQ 2000



Quinze & milan

INFINITY

Infinity allows you to play with basic shapes. Besides the most common straight version, the following connection pieces offers you to create a versatile and dynamic setting.

Contact our sales office for more pricing options.



INFINITY CORNER



Infinity corner QM FOAM

INFINITY L-SEAT



Infinity L-seat QM FOAM

INFINITY Z-SEAT

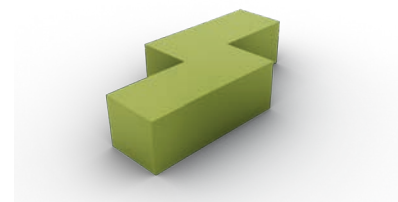

Infinity Z-seat QM FOAM

All pricing in other finishings, such as QM Plus, QM Upholstering is available. Please check our sales office for detailed prices and send us your needs, so we can provide you with the right quote

INFINITY CURVE S



Infinity curve S QM FOAM

INFINITY CURVE M



Infinity curve M QM FOAM

INFINITY CURVE L



Infinity curve L QM FOAM

All pricing in other finishings, such as QM Plus, QM Upholstering is available. Please check our sales office for detailed prices and send us your needs, so we can provide you with the right quote

INFINITY CURVE XL



Infinity curve XL QM FOAM

CHOOSE YOUR TOPVIEW:

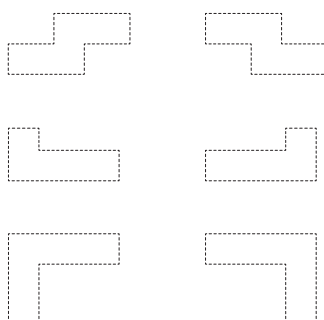

IMPORTANT / QM AIR VENT

Upon ordering, please mention on which side Air Vents have to be integrated.

By allowing the QM FOAM to breathe the inside pressure remains controlled, which gives enhanced seating comfort throughout the cushion. Aerating PU foam extends its flexibility, reduces the stress on the individual cells which therefore keep their elasticity much longer. This keeps the foam from wrinkling or loosing its shape.

0 = product price in calculation - contact our office for pricing

LEAF bench

DESIGN Kazuko Okamoto

2018

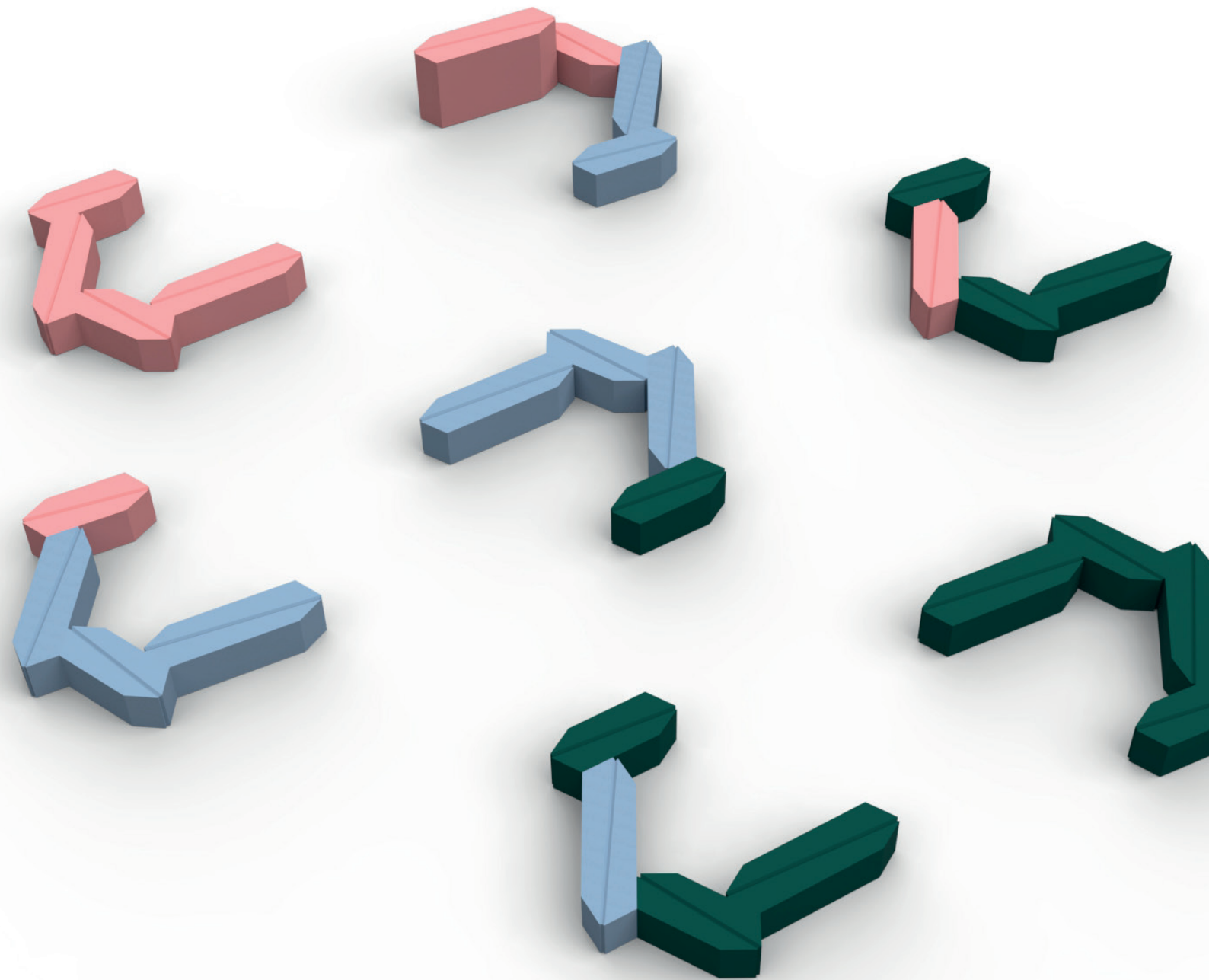

0 = product price in calculation - contact our office for pricing

LEAF bench

DESIGN Kazuko Okamoto

2018

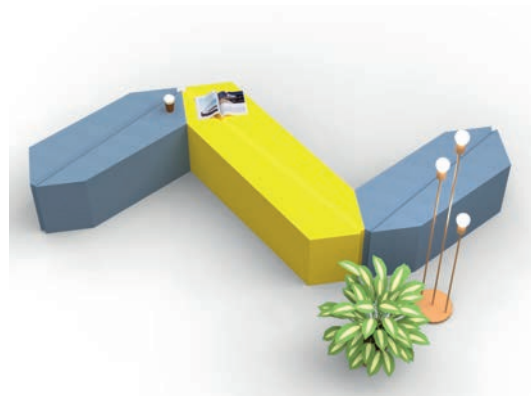

LEAF BENCH SMALL

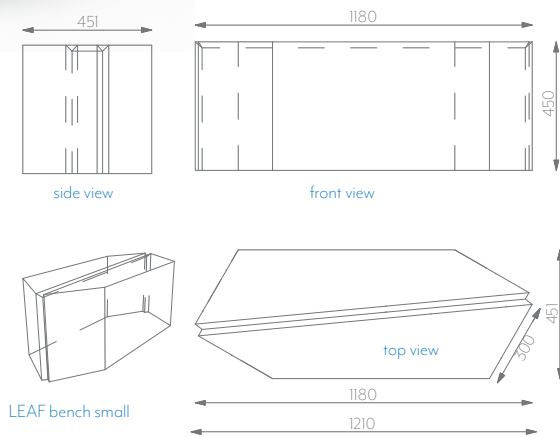
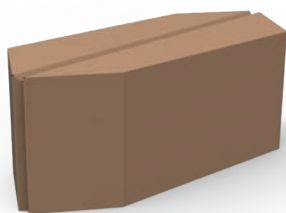

LEAF - small - QM Foam skin

LEAF - small - QM Plus foamskin double

LEAF BENCH LARGE

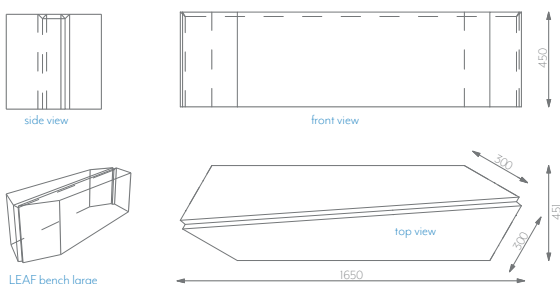
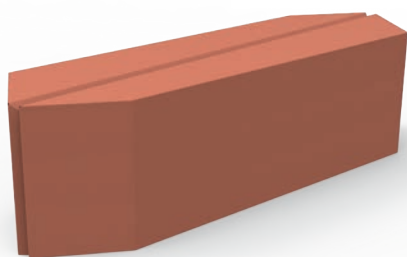

LEAF - large - QM Foam skin

LEAF - large - QM Plus foamskin double

0 = product price in calculation - contact our office for pricing



PLATFORM
FOR
FURNITURE

A large section of the page containing 30 horizontal lines for writing or drawing, spaced evenly down the page.

LEAF bench

DESIGN Kazuko Okamoto

2018

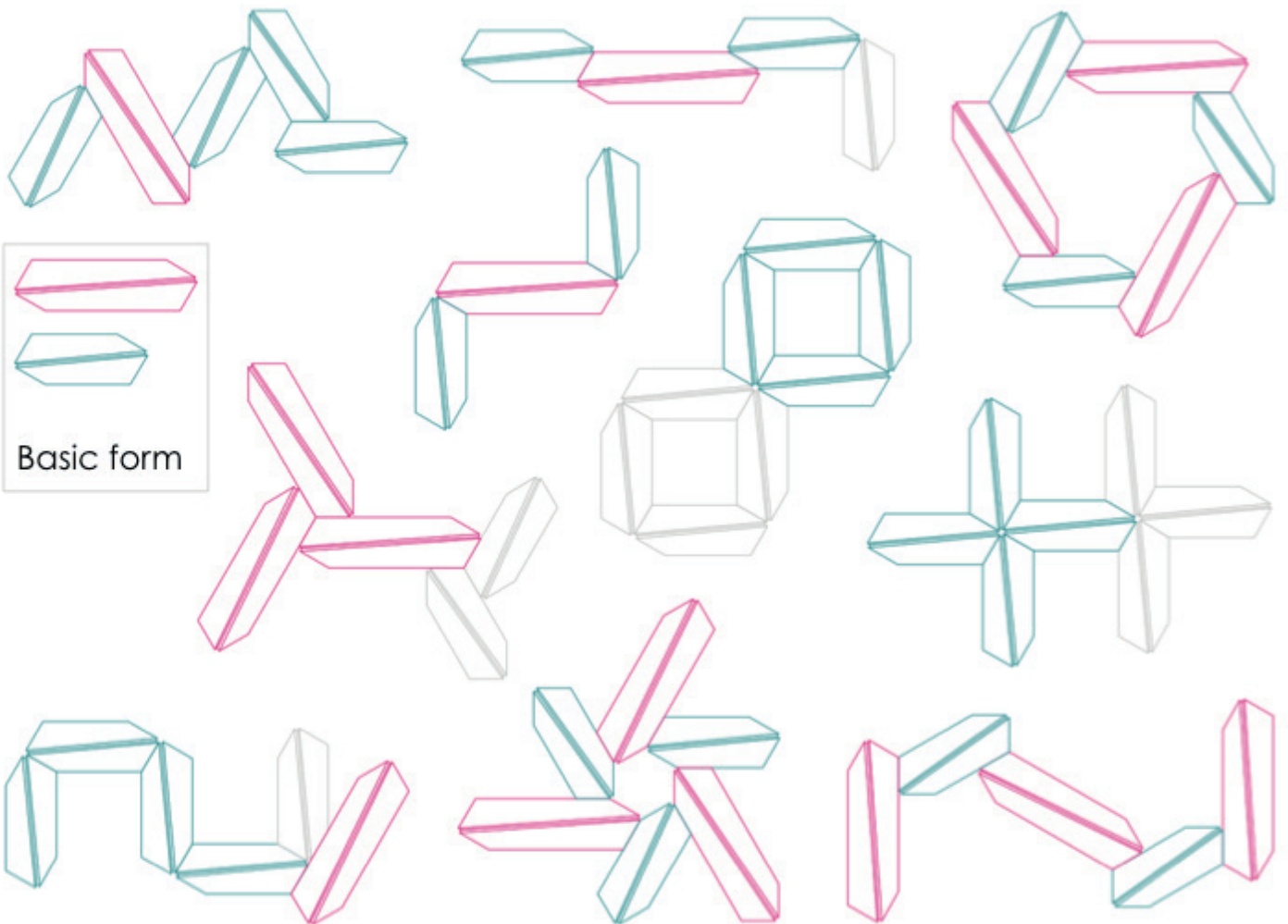
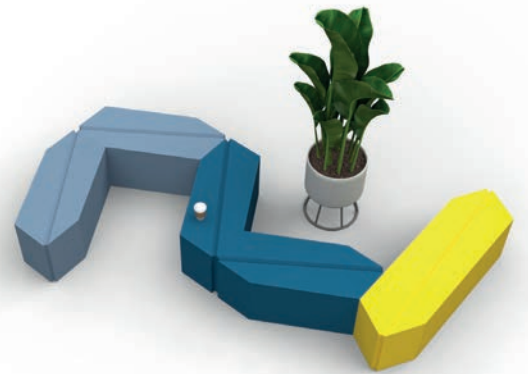
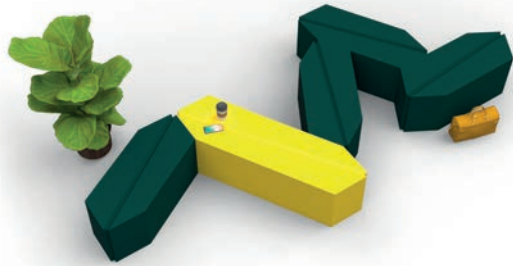

0 = product price in calculation - contact our office for pricing



0 = product price in calculation - contact our office for pricing

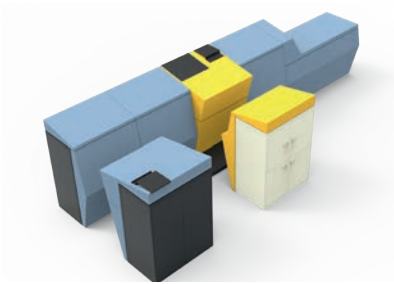

LEAN is multifunctional furniture system that responds to the needs of a contemporary workday-life, stimulating both body and mind, while overlaying different functions in the office environment. With the aim to avoid sitting for long periods of time while working, this modular furniture arrangement provides a dynamic exchange between sitting, standing and leaning to encourage movement and posture change as well as provide social interaction.

By developing versatile ergonomic uses, the system allows comfortable standing or elevated seating. The designs are ideal for leaning and lounging, and the furniture invites people to move out of the static sitting routine during temporary working, relaxing, phoning, meeting and communicating.



LEAN MODULE B

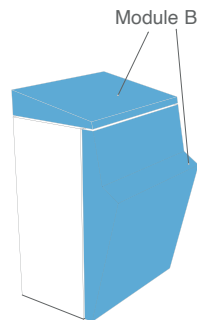

Development of this product is still in progress.
Discover some of our pricing options for existing models
for more information contact our sales office

Lean - foam module A - QM Foam skin

Lean foam module A - QM Plus foamskin double

Lean - foam module B - QM Foam skin

Lean foam module B - QM Plus foamskin double

Lean - foam module C - QM Foam skin

Lean foam module C - QM Plus foamskin double

Lean - foam module D - QM Foam skin

Lean foam module D - QM Plus foamskin double

Lean - foam module E - QM Foam skin

Lean foam module E - QM Plus foamskin double

The pricing is for the foam module only.

Pricing for cupboard system is depending on the chosen storage units.

LEAN MODULE C

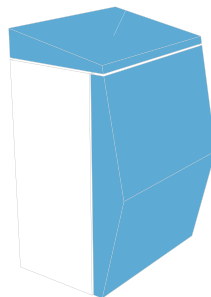
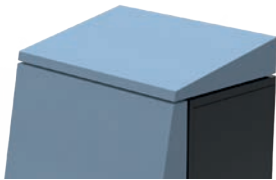

LEAN MODULE E

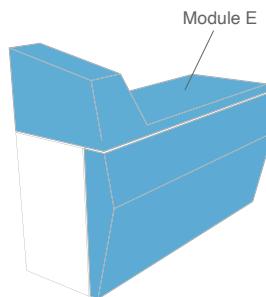

LITTLE MISS O
DESIGN CONCRETE AMSTERDAM



Quinze & milan



0 = product price in calculation - contact our office for pricing

LITTLE MISS O

DESIGN CONCRETE AMSTERDAM



Quinze & milan

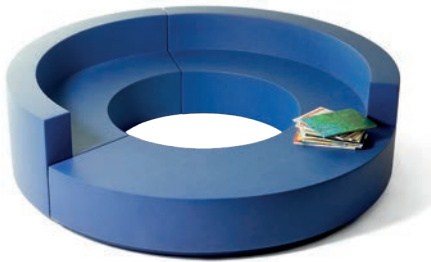

When UN Studio asked them to design certain areas for their major project, the Mercedes Benz Museum in Stuttgart, Germany, CONCRETE AMSTERDAM based all its designwork, down to the very detail on the specific identity of the owner. Their aim was to create identity within a total space experience: create individual worlds where a single visitor identifies with and which invites him to stay. The dishes, table linen and silverware in the restaurant as well as the division of the spaces are all in a way renditions of the three-pointed Mercedes Benz logo. LITTLE MISS O, which is placed in the children island, is a result from that research and provides an ideal playground where to nurse children and play with them.

Custom color or sizes are available upon request.

LITTLE MISS O SMALL

*DELIVERY KNOCK DOWN IN THREE PIECES

LITTLE MISS O SMALL COMPLETE

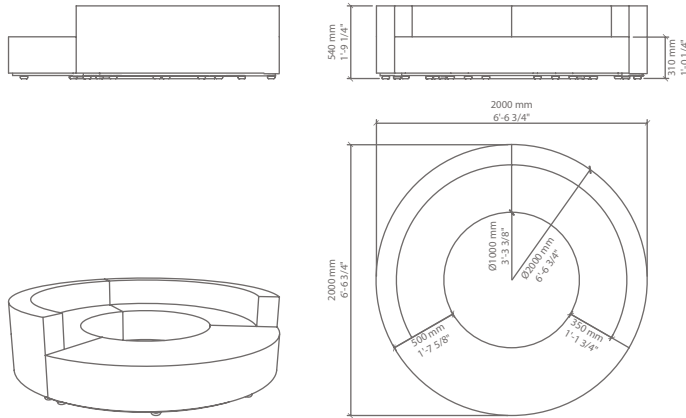

- Little Miss O small complete (no floor) QM Foam skin
- Little Miss O small complete (no floor) QM Plus foamskin double
- Little Miss O small complete (no floor) QM Tex foamskin Tex
- Little Miss O small complete (no floor) QM CAT 1
- Little Miss O small complete (no floor) QM CAT 2
- Little Miss O small complete (no floor) QM CAT 0/COM

LITTLE MISS O SMALL - bench with backrest

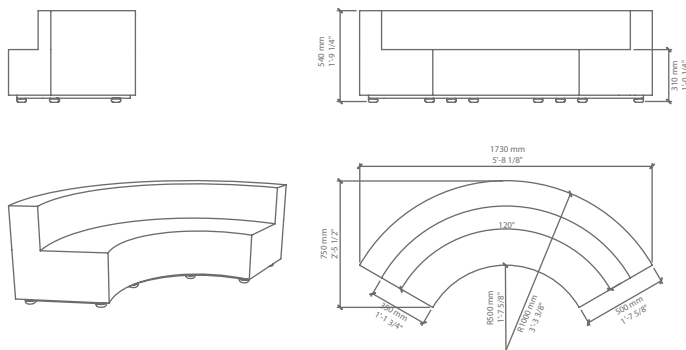

- Little Miss O small - bench with backrest QM Foam skin
- Little Miss O small - bench with backrest QM Plus foamskin double
- Little Miss O small - bench with backrest QM Tex foamskin Tex
- Little Miss O small - bench with backrest QM CAT 1
- Little Miss O small - bench with backrest QM CAT 2
- Little Miss O small - bench with backrest QM CAT 0/COM

LITTLE MISS O SMALL - bench without backrest

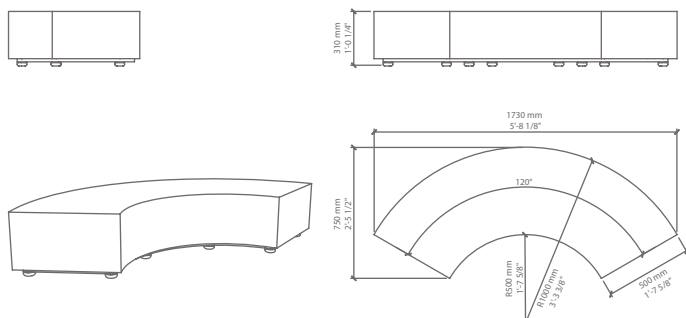

- Little Miss O small - bench QM Foam skin
- Little Miss O small - bench QM Plus foamskin double
- Little Miss O small - bench QM Tex foamskin Tex
- Little Miss O small - bench QM CAT 1
- Little Miss O small - bench QM CAT 2
- Little Miss O small - bench QM CAT 0/COM

0 = product price in calculation - contact our office for pricing

LITTLE MISS O

DESIGN CONCRETE AMSTERDAM



Quinze & milan



When UN Studio asked them to design certain areas for their major project, the Mercedes Benz Museum in Stuttgart, Germany, CONCRETE AMSTERDAM based all its designwork, down to the very detail on the specific identity of the owner. Their aim was to create identity within a total space experience: create individual worlds where a single visitor identifies with and which invites him to stay. The dishes, table linen and silverware in the restaurant as well as the division of the spaces are all in a way renditions of the three-pointed Mercedes Benz logo. LITTLE MISS O, which is placed in the children island, is a result from that research and provides an ideal playground where to nurse children and play with them.

Custom color or sizes are available upon request.

LITTLE MISS O LARGE

*DELIVERY KNOCK DOWN IN FOUR PIECES

LITTLE MISS O LARGE COMPLETE

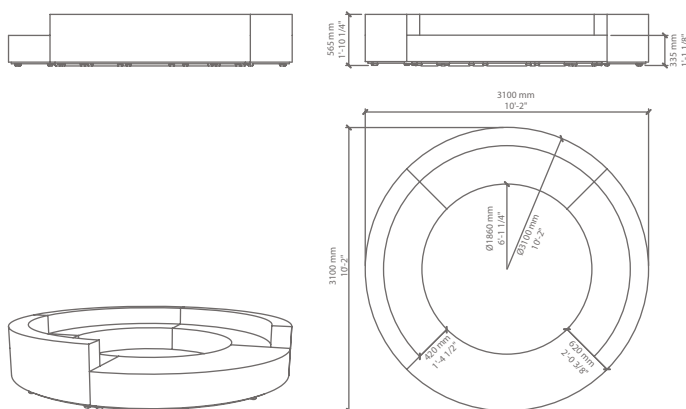

- Little Miss O large complete (no floor) QM Foam skin
- Little Miss O large complete (no floor) QM Plus foamskin double
- Little Miss O large complete (no floor) QM Tex foamskin Tex
- Little Miss O large complete (no floor) QM CAT 1
- Little Miss O large complete (no floor) QM CAT 2
- Little Miss O large complete (no floor) QM CAT 0/COM

LITTLE MISS O LARGE - bench with backrest

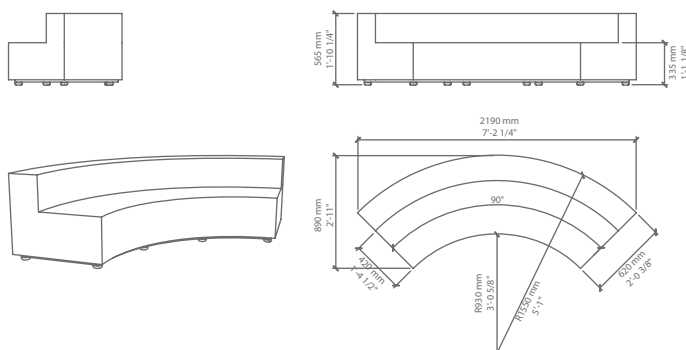

- Little Miss O large - bench with backrest QM Foam skin
- Little Miss O large - bench with backrest QM Plus foamskin double
- Little Miss O large - bench with backrest QM Tex foamskin Tex
- Little Miss O large - bench with backrest QM CAT 1
- Little Miss O large - bench with backrest QM CAT 2
- Little Miss O large - bench with backrest QM CAT 0/COM

LITTLE MISS O LARGE - bench without backrest

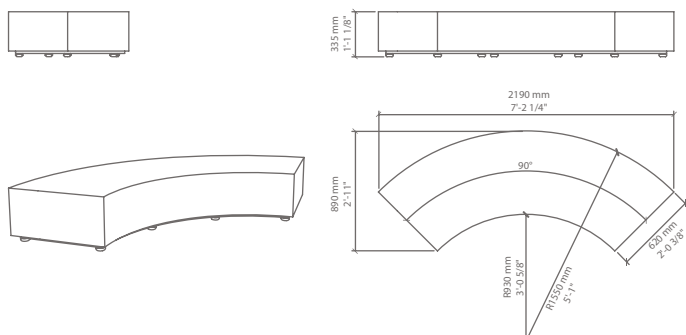

- Little Miss O large - bench QM Foam skin
- Little Miss O large - bench QM Plus foamskin double
- Little Miss O large - bench QM Tex foamskin Tex
- Little Miss O large - bench QM CAT 1
- Little Miss O large - bench QM CAT 2
- Little Miss O large - bench QM CAT 0/COM

0 = product price in calculation - contact our office for pricing

M2

DESIGN SCOTT WILSON

2003



Quinze & milan



0 = product price in calculation - contact our office for pricing

M2

DESIGN SCOTT WILSON

2003



Quinze & milan

Flexible by nature and ideal for large public spaces, the M2 is a modular seating system designed by Scott Wilson for Quinze & Milan. Three basic units (corner, linear and level units), each 1m2, supported by powder-coated steel frames fit together to form the desired configuration. Components can be interconnected or can stand alone. Light fittings can be integrated into the seating elements. M2 has received enthusiastic reviews, as well as honourable mentions at the ISDA Awards and the prestigious ID Design Awards.

Steel elements are powder-coated in standard grey (RAL 9007) and black (RAL 9005). Sidetable standard grey or black.

M2 FLAT

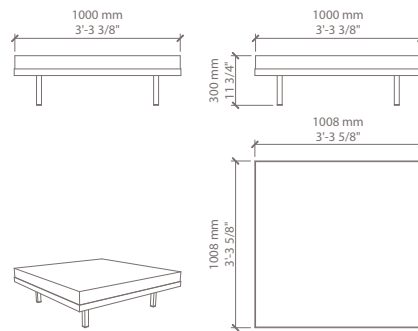

- M2 incl. Base flat QM Foam skin
- M2 incl. Base flat QM Plus foamskin double
- M2 incl. base flat QM Tex foamskin Tex
- M2 incl. Base flat QM CAT 1
- M2 incl. Base flat CAT 2
- M2 incl. Base flat QM CAT 0/COM

M2 CORNER

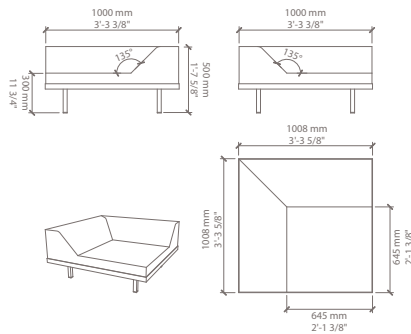

- M2 incl. Base corner QM Foam skin
- M2 incl. Base corner QM Plus foamskin double
- M2 incl. Base corner QM Tex foamskin Tex
- M2 incl. Base corner QM CAT 1
- M2 incl. Base corner CAT 2
- M2 incl. Base corner QM CAT 0/COM

M2 STRAIGHT

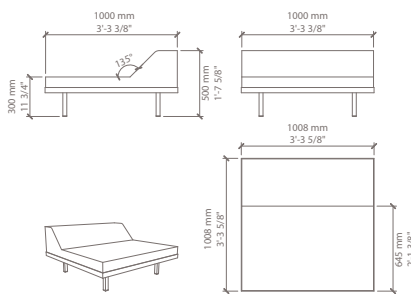

- M2 incl. Base straight QM Foam skin
- M2 incl. Base straight QM Plus foamskin double
- M2 incl. Base straight QM Tex foamskin Tex
- M2 incl. Base straight QM CAT 1
- M2 incl. Base straight CAT 2
- M2 incl. Base straight QM CAT 0/COM

M2 SIDE TABLE

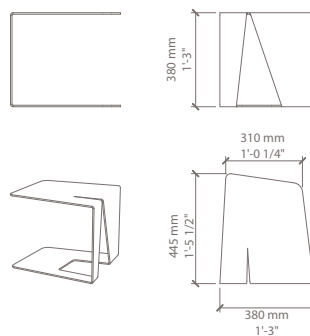

M2 side table Metal powdercoated

0 = product price in calculation - contact our office for pricing

MATRASS
DESIGN SAQ
2000



Quinze & milan



0 = product price in calculation - contact our office for pricing

MATRASS

DESIGN SAQ

2000



Quinze & milan



MATRASS, an offspring of PRIMARY that was purpose-designed for lounge settings, is available in four sizes, with or without backrests. All pieces can be mixed and matched to create unique arrangements. MATRASS fits right into any number of environments. Tuck it into a corner of the loft or living room. Use it in the children's room. Park it next to the swimming pool, or add an extra level of comfort to the wellness space.

MATRASS is also available upholstered in leather and fabric.
Custom color or sizes are available upon request.

MATRASS SEAT 75

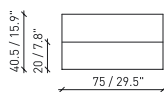
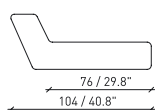

Matrass SEAT 75 QM Foam skin

Matrass SEAT 75 QM Plus foamskin double

MATRASS SEAT 150

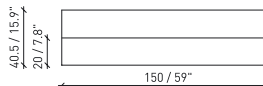
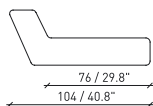

Matrass SEAT 150 QM Foam skin

Matrass SEAT 150 QM Plus foamskin double

MATRASS MAT 75

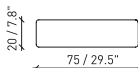
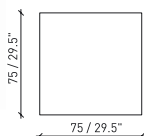

Matrass MAT 75 QM Foam skin

Matrass MAT 75 QM Plus foamskin double

MATRASS MAT 150

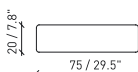
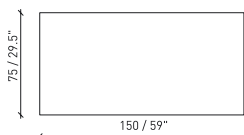

Matrass MAT 150 QM Foam skin

Matrass MAT 150 QM Plus foamskin double

0 = product price in calculation - contact our office for pricing

NORA

DESIGN Lionel DOYEN

2017



ALSO
AVAILABLE IN
OUTDOOR
VERSION



0 = product price in calculation - contact our office for pricing

NORA

DESIGN Lionel DOYEN

2017



NORA allows you to play with seats, backrests and armrests.

Each sofa is modular and is built up based on 4 standard frames.

All elements are fixed to a base plate, but can easily be re-arranged. All cushions can be upholstered with different fabrics of your choice.

The baseframe is aluminum with a powdercoating and the feet are wooden legs in oak natural. The complete sofa can be adapted to outdoor use, by changing the wooden feet to acacia, cushions and fabrics in outdoor suitable materials.

Contact our sales office for more pricing options.

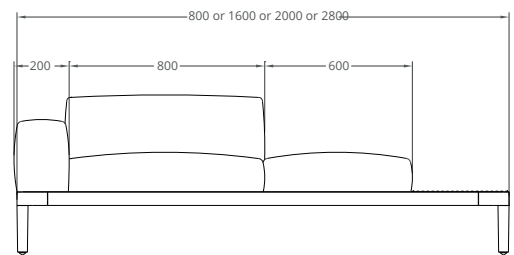
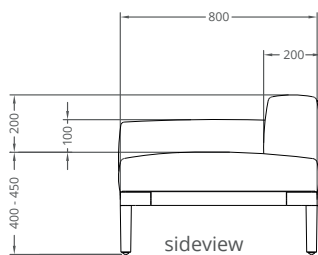

Frontview

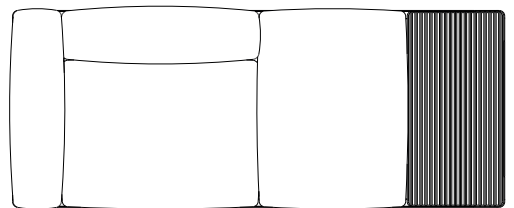
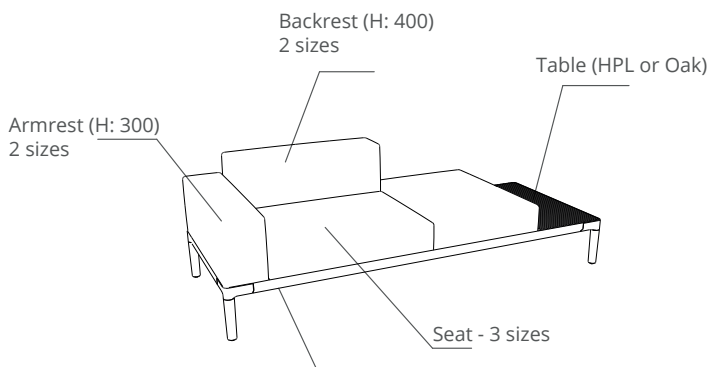

Topview

0 = product price in calculation - contact our office for pricing

NORA

NORA allows you to play with seats, backrests and armrests.

Each sofa is modular and is built up based on 4 standard frames.

Contact our sales office for more pricing options.



Frames

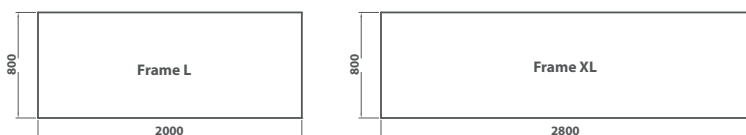
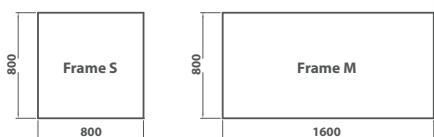

Nora - frame s 80 - Metal powdercoated/oak legs

Nora - frame M 160 - Metal powdercoated/oak legs

Nora - frame L 200 - Metal powdercoated/oak legs

Nora - frame XL 280 - Metal powdercoated/oak legs

Seats

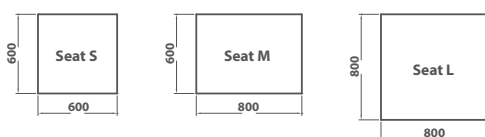

Nora - Seat S 60x60 - fabric CAT 0/COM

Nora - Seat S 60x60 - fabric CAT 1

Nora - Seat S 60x60 - fabric CAT 2

Nora - Seat M 80x60 - fabric CAT 0/COM

Nora - Seat M 80x60 - fabric CAT 1

Nora - Seat M 80x60 - fabric CAT 2

Nora - Seat L 80x80 - fabric CAT 0/COM

Nora - Seat L 80x80 - fabric CAT 1

Nora - Seat L 80x80 - fabric CAT 2

Armrests

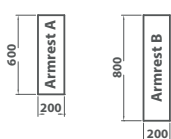

Nora - Armrest A - fabric CAT 0/COM

Nora - Armrest A - fabric CAT 1

Nora - Armrest A - fabric CAT 2

Nora - Armrest B - fabric CAT 0/COM

Nora - Armrest B - fabric CAT 1

Nora - Armrest B - fabric CAT 2

Backrests



Nora - Backrest A - fabric CAT 0/COM

Nora - Backrest A - fabric CAT 1

Nora - Backrest A - fabric CAT 2

Nora - Backrest B - fabric CAT 0/COM

Nora - Backrest B - fabric CAT 1

Nora - Backrest B - fabric CAT 2

Tables

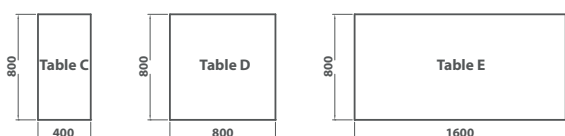
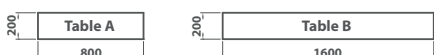

Nora - table A - HPL 20*80cm

Nora - table B - HPL 160*20cm

Nora - table C - HPL 80*40cm

Nora - table D - HPL 80*80cm

Nora - table A - wood 20*80cm - oak pattern

Nora - table B - wood 20*160cm - oak pattern

Nora - table C - wood 80*40cm - oak pattern

Nora - table D - wood 80*80cm - oak pattern

0 = product price in calculation - contact our office for pricing

some proposals based on **frame S**

MODEL S_01

Nora - Model S01 - CAT 0/COM

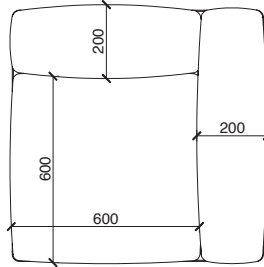

parts list:
Frame S
Seat S
Armrest B
Backrest A

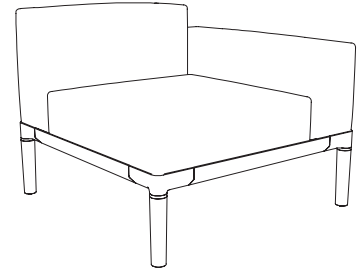

MODEL S_02

Nora - Model S02 - CAT 0/COM

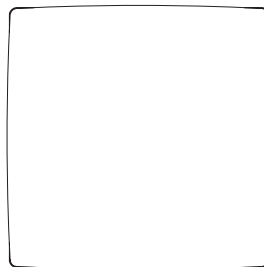

parts list:
Frame S
Seat L

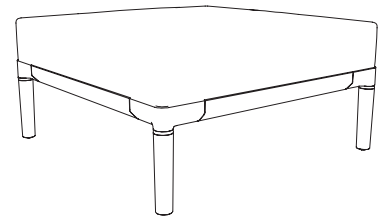

MODEL S_03

Nora - Model S03 - CAT 0/COM

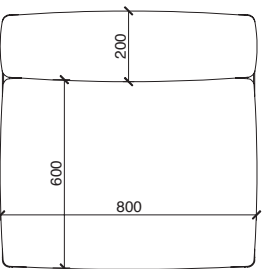

parts list:
Frame S
Seat M
Armrest B

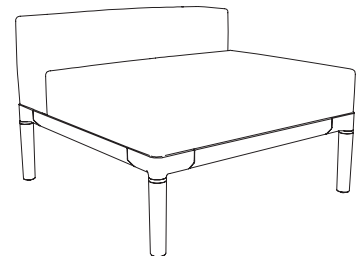

MODEL S_04

Nora - Model S04 - CAT 0/COM

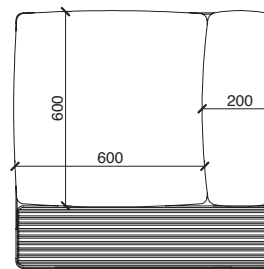

parts list:
Frame S
Seat S
backrest A
Table HPL or Oak

pricing for version with HPL table
not like on the image (oak table, price on request)

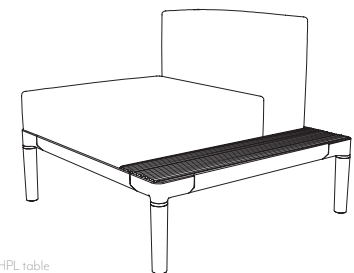

MODEL S_05

Nora - Model S05 - CAT 0/COM

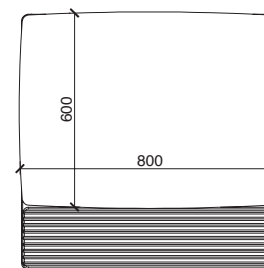

parts list:
Frame S
Seat M
Table HPL or Oak

pricing for version with HPL table
not like on the image (oak table, price on request)



0 = product price in calculation - contact our office for pricing

NORA

DESIGN Lionel DOYEN

2017



MODEL S_06

Nora - Model S06 - table oak pattern

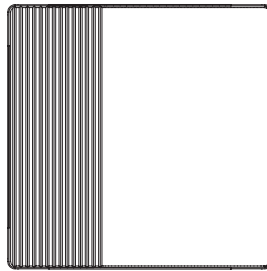

parts list:
Frame S
Table HPL or Oak

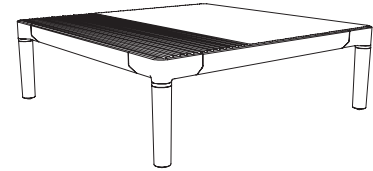

some proposals based on [frame M](#)

MODEL M_01

Nora - Model M01 - CAT 0/COM



parts list:
Frame M
2 x Seat S
2 x Armrest B
2 x Backrest A

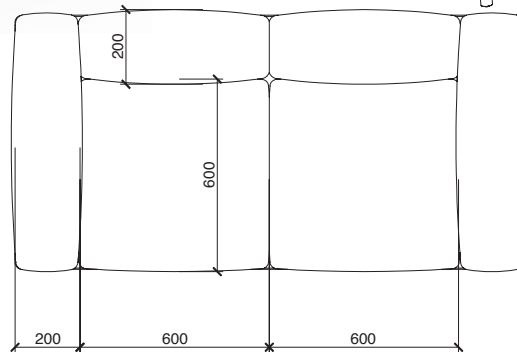
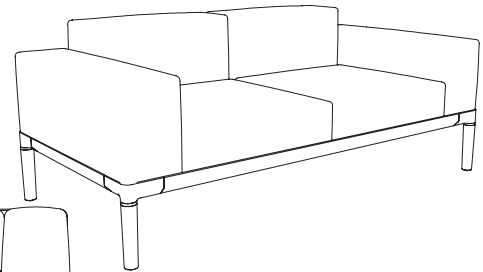

MODEL M_02

Nora - Model M02 - CAT 0/COM



parts list:
Frame M
2 x Seat L

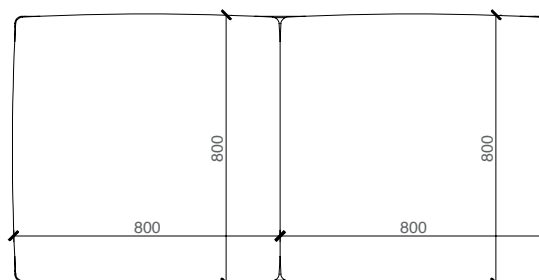
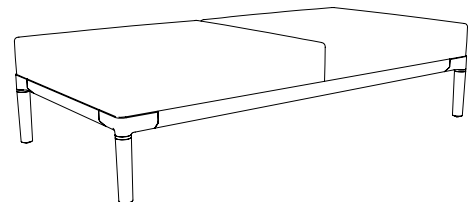

0 = product price in calculation - contact our office for pricing

NORA

DESIGN Lionel DOYEN

2017



MODEL M_03

- parts list:
Frame M
2 x Seat M
Wooden table HPL or Oak

Nora - Model M03 - CAT 0/COM

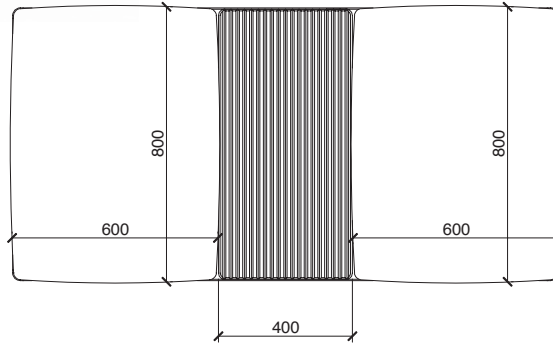
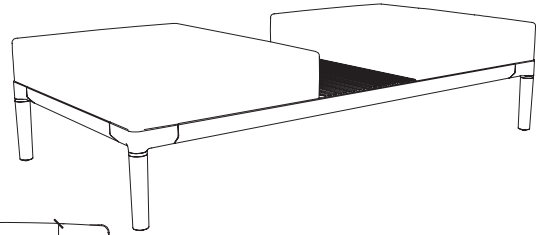

MODEL M_04

- parts list:
Frame M
2 x Seat M
2 x Armrest B

Nora - Model M04 - CAT 0/COM

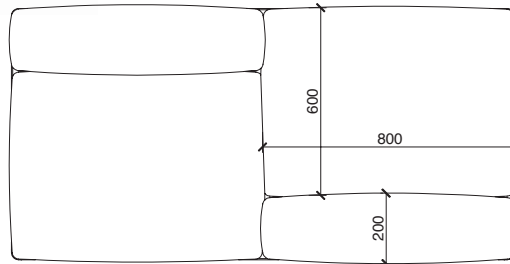
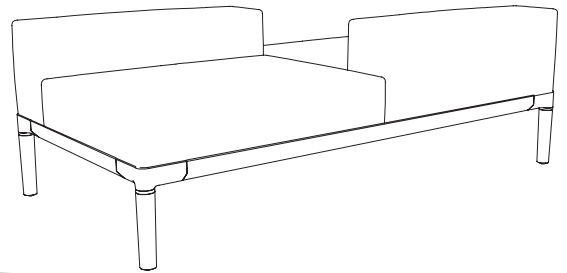

MODEL M_05

- parts list:
Frame M
Seat S
Seat M
2 x Armrest B

Nora - Model M05 - CAT 0/COM

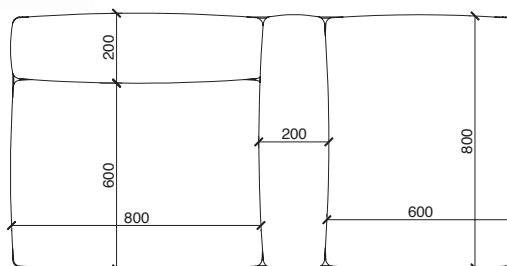
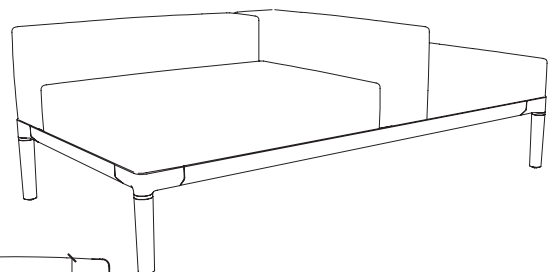

0 = product price in calculation - contact our office for pricing

MODEL M_06

- parts list:
 Frame M
 Seat M
 Seat S
 Backrest A

Nora - Model M06 - CAT 0/COM

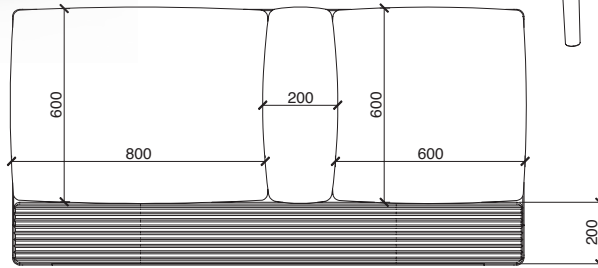
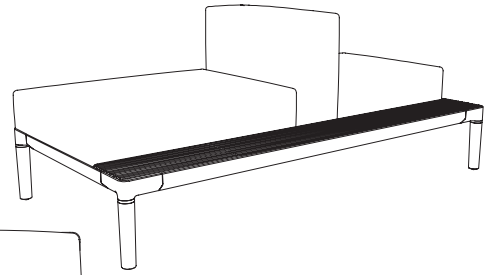

MODEL M_07

- parts list:
 Frame M
 2 x Seat S
 2 x Backrest A
 Wooden table HPL or Oak

Nora - Model M07 - CAT 0/COM

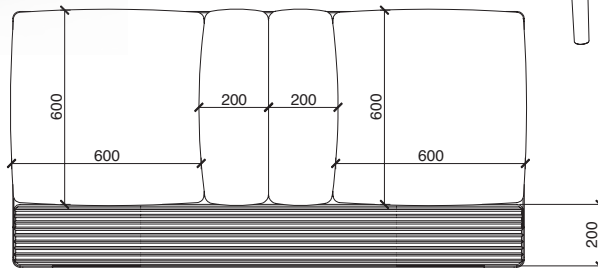
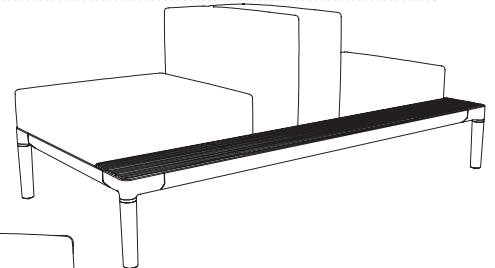

MODEL M_08

- parts list:
 Frame M
 2 x Seat S
 2 x Backrest A
 Wooden table HPL or Oak

Nora - Model M08 - CAT 0/COM

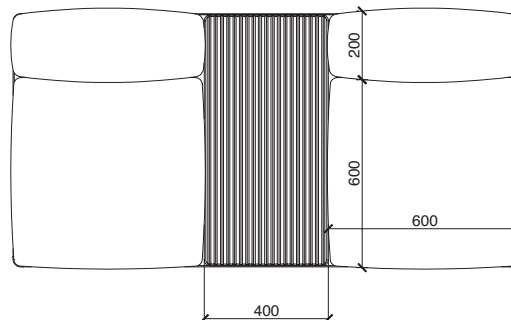
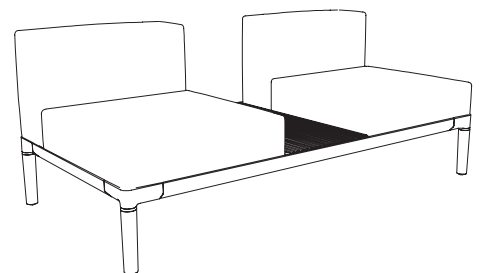

0 = product price in calculation - contact our office for pricing

MODEL L_01

Nora - Model L01 - CAT 0/COM

- parts list:
 Frame L
 2 x Seat L
 2 x Armrest B
 2 x Backrest B

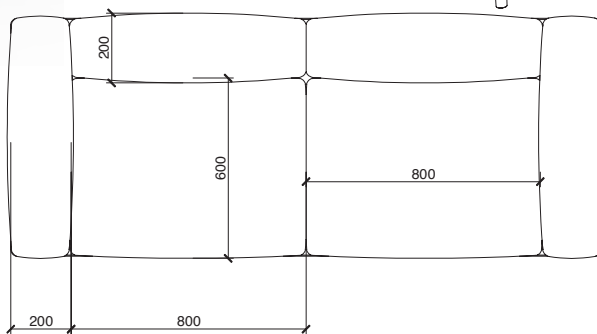
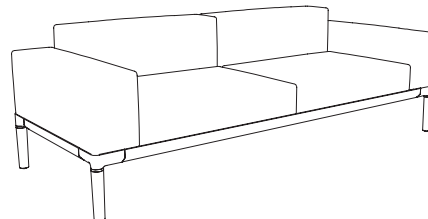

MODEL L_02

Nora - Model L02 - CAT 0/COM

- parts list:
 Frame L
 2 x Seat S
 2 x Backrest A
 2 x Armrest B

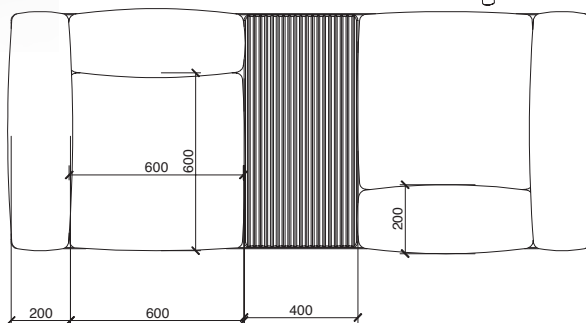
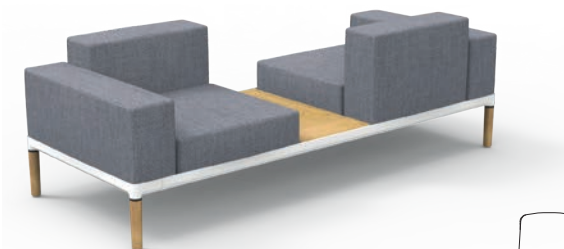
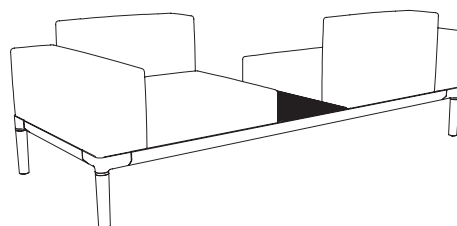

MODEL L_03

Nora - Model L03 - CAT 0/COM

- parts list:
 Frame L
 3 x Seat S
 3 x Backrest A
 Armrest B

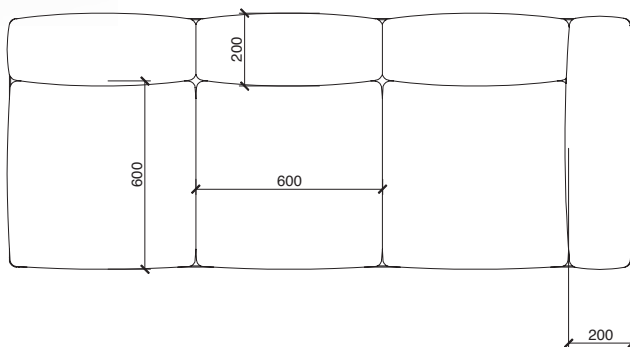
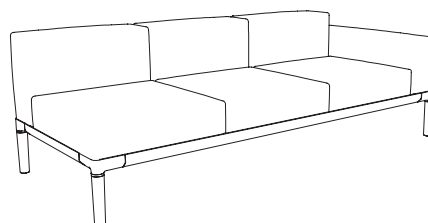

0 = product price in calculation - contact our office for pricing

NORA

DESIGN Lionel DOYEN

2017



MODEL L_04

Nora - Model L04 - CAT 0/COM

- parts list:
 Frame L
 3 x Seat S
 3 x Backrest A
 armrest B

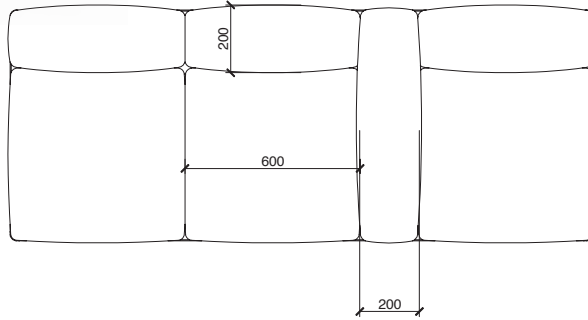
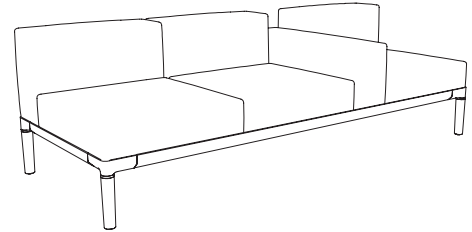

MODEL L_05

Nora - Model L05 - CAT 0/COM

- parts list:
 Frame L
 2 x Seat L
 4 x armrest B

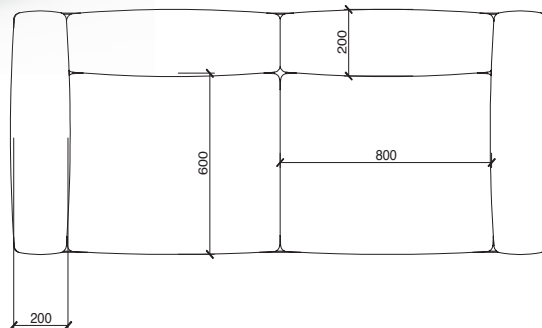
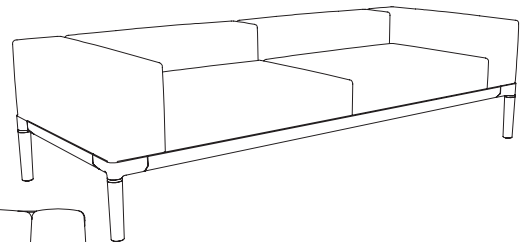

MODEL L_06

Nora - Model L06 - CAT 0/COM

- parts list:
 Frame L
 2 X Seat M
 2 x armrest A
 table C

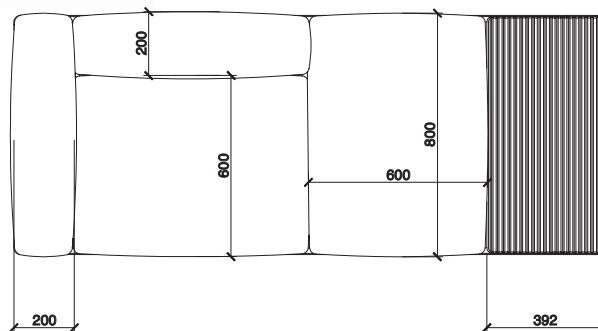
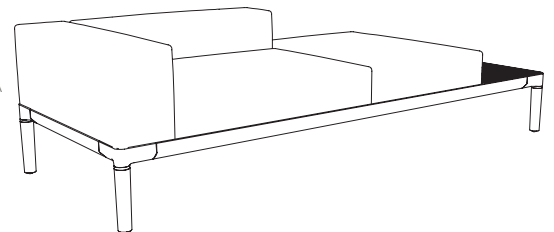

0 = product price in calculation - contact our office for pricing

NORA

DESIGN Lionel DOYEN

2017



MODEL XL_01

parts list:
Frame XL
3 x Seat S
3 x Backrest A
2 x armrest B

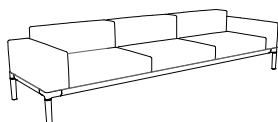
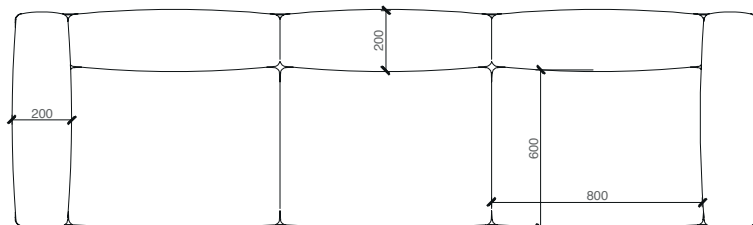
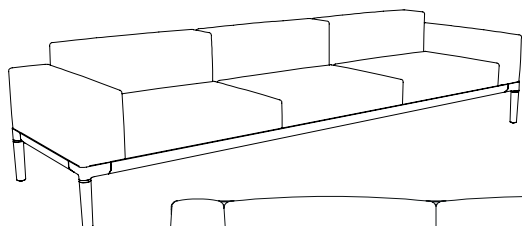

Nora XL 01

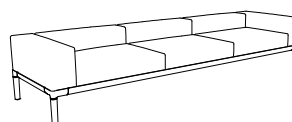

Nora XL 02

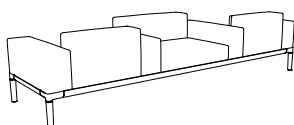

Nora XL 03

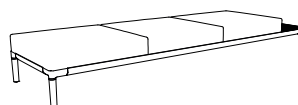

Nora XL 04

0 = product price in calculation - contact our office for pricing



0 = product price in calculation - contact our office for pricing



0 = product price in calculation - contact our office for pricing

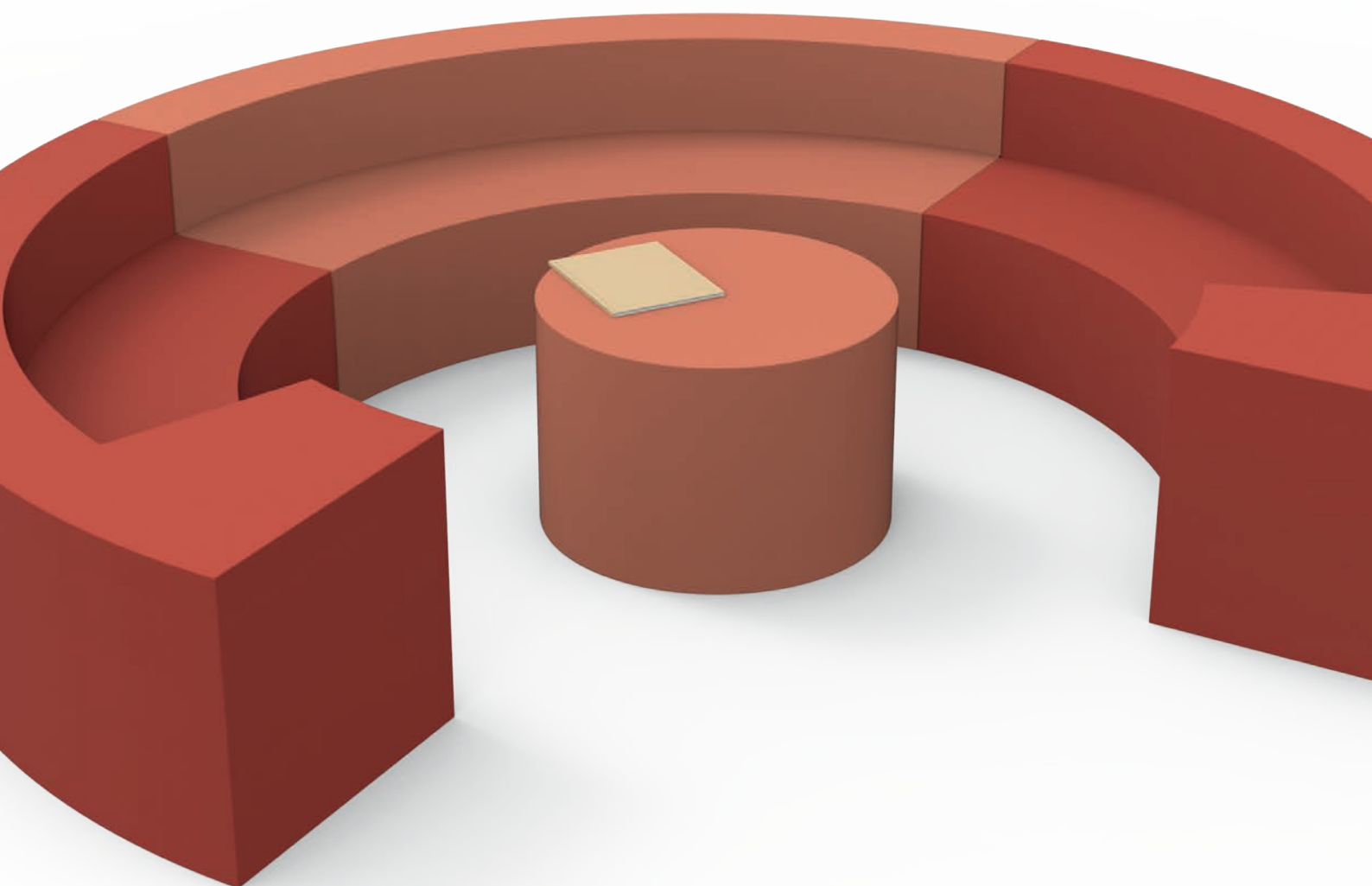



OSAKA is the new circular bench system. Gathering around a curved bench increases interaction and social communication.

This system is built up out of 4 standard modules: a curved bench without backrest, a curved bench with backrest, a curved bench with backrest and armrest (left or right) and a circular bench with extra seating at the outside.

Custom color or sizes are available upon request.

OSAKA BENCH WITH BACKREST & ARMREST (LEFT OR RIGHT)

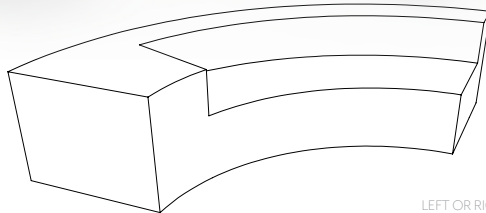
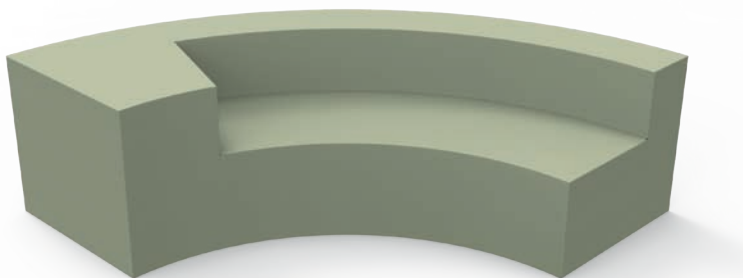

LEFT OR RIGHT VERSION

-
- Osaka - Bench WITH backrest & armrest - QM Foam skin
-
- Osaka - Bench WITH backrest & armrest - QM Plus foamskin double
-
- Osaka - Bench WITH backrest & armrest - QM Tex foamskin Tex
-
- Osaka - Bench WITH backrest & armrest - fabric CAT 0/COM
-
- Osaka - Bench WITH backrest & armrest - fabric CAT 1
-
- Osaka - Bench WITH backrest & armrest - fabric CAT 2
-

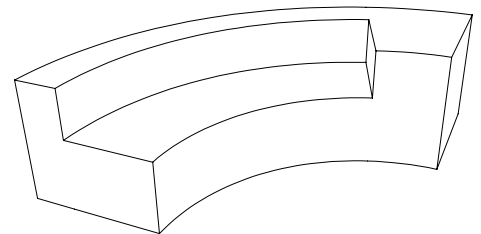

OSAKA BENCH WITH BACKREST AND MIRRORED SEAT

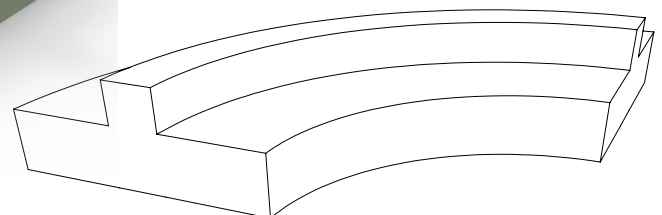
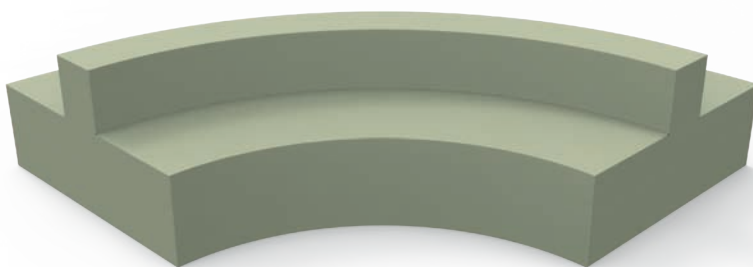

-
- Osaka - Bench mirror WITH backrest - QM Foam skin
-
- Osaka - Bench mirror WITH backrest - QM Plus foamskin double
-
- Osaka - Bench mirror WITH backrest - QM Tex foamskin Tex
-
- Osaka - Bench mirror WITH backrest - fabric CAT 0/COM
-
- Osaka - Bench mirror WITH backrest - fabric CAT 1
-
- Osaka - Bench mirror WITH backrest - fabric CAT 2
-

0 = product price in calculation - contact our office for pricing

OSAKA BENCH

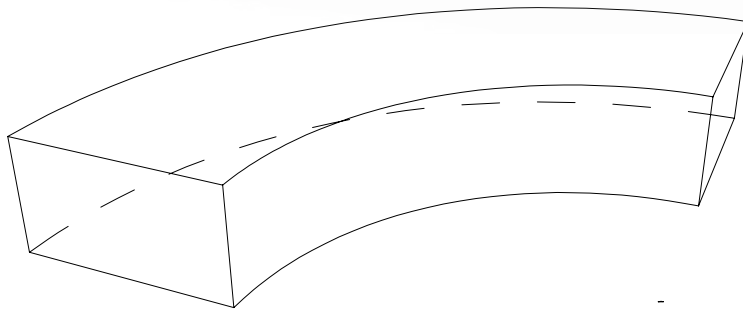
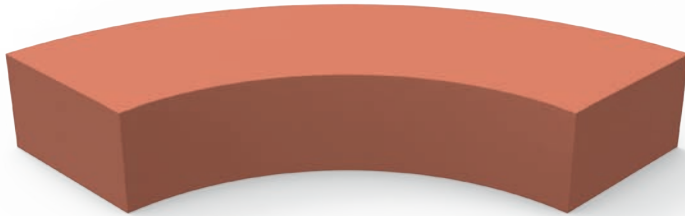

-
- Osaka - Bench NO backrest - QM Foam skin
-
- Osaka - Bench NO backrest - QM Plus foamskin double
-
- Osaka - Bench NO backrest - QM Tex foamskin Tex
-
- Osaka - Bench NO backrest - fabric CAT 0/COM
-
- Osaka - Bench NO backrest - fabric CAT 1
-
- Osaka - Bench NO backrest - fabric CAT 2
-

OSAKA BENCH WITH BACKREST

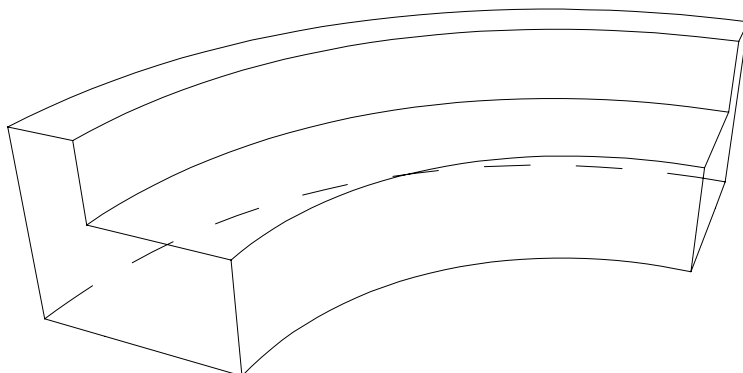
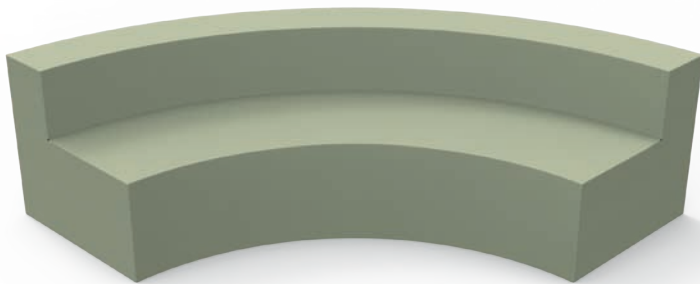

-
- Osaka - Bench WITH backrest - QM Plus foamskin double
-
- Osaka - Bench WITH backrest - QM Tex foamskin Tex
-
- Osaka - Bench WITH backrest - fabric CAT 0/COM
-
- Osaka - Bench WITH backrest - fabric CAT 1
-
- Osaka - Bench WITH backrest - fabric CAT 2
-

0 = product price in calculation - contact our office for pricing

PENTAGON

DESIGN THOMAS TRITSCH

2007



Quinze & milan

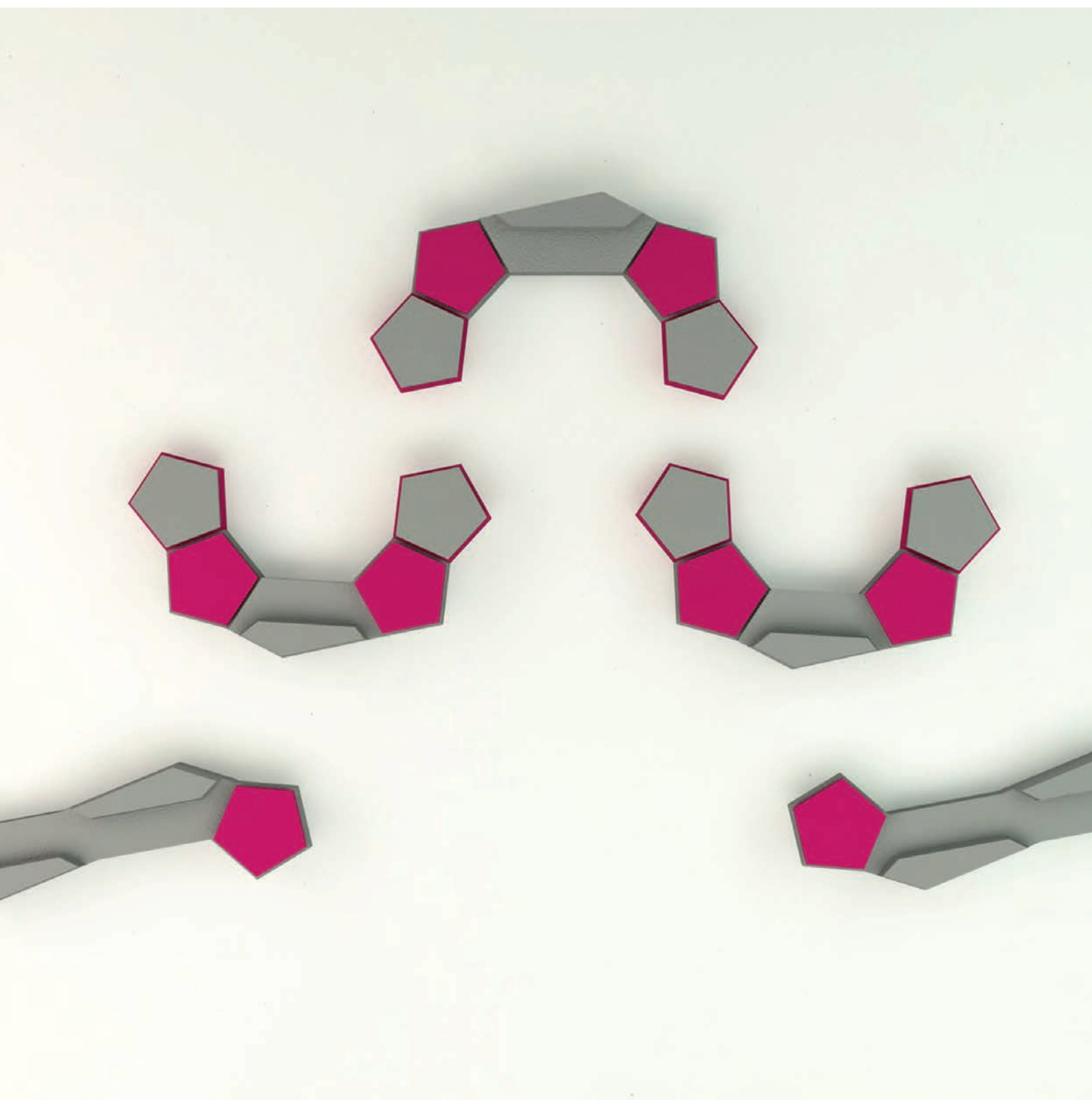

0 = product price in calculation - contact our office for pricing

PENTAGON

DESIGN THOMAS TRITSCH

2007



Quinze & milan

STEAMSHIP

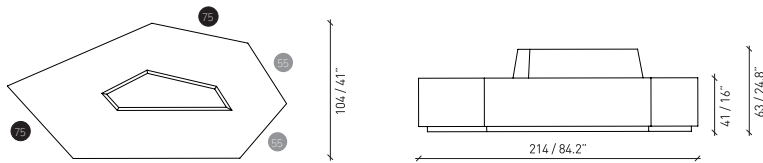

-
- Pentagon Steamship QM Foam skin
-
- Pentagon Steamship QM Plus foamskin double
-
- Pentagon Steamship QM Tex foamskin Tex
-
- Pentagon Steamship QM CAT 1
-
- Pentagon Steamship QM CAT 2
-
- Pentagon Steamship QM CAT 0/COM
-

SOFA SMALL

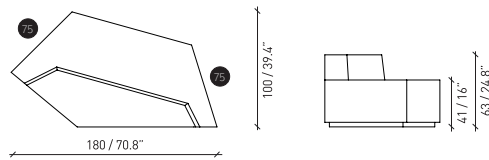

-
- Pentagon sofa small QM Foam skin
-
- Pentagon sofa small QM Plus foamskin double
-
- Pentagon sofa small QM Tex foamskin Tex
-
- Pentagon sofa small QM CAT 1
-
- Pentagon sofa small QM CAT 2
-
- Pentagon sofa small QM CAT 0/COM
-

SOFA LARGE

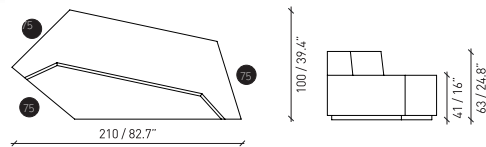

-
- Pentagon sofa Large QM Foam skin
-
- Pentagon sofa Large QM Plus foamskin double
-
- Pentagon sofa Large QM Tex foamskin Tex
-
- Pentagon sofa Large QM CAT 1
-
- Pentagon sofa Large QM CAT 2
-
- Pentagon sofa Large QM CAT 0/COM
-

LINKING PIECE

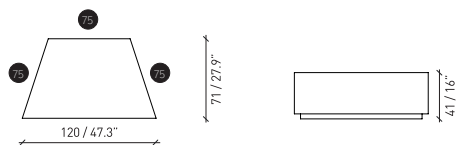
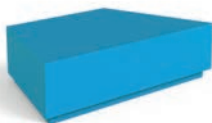

-
- Pentagon linking piece QM Foam skin
-
- Pentagon linking piece QM Plus foamskin double
-
- Pentagon linking piece QM Tex foamskin Tex
-
- Pentagon linking piece QM CAT 1
-
- Pentagon linking piece QM CAT 2
-
- Pentagon linking piece QM CAT 0/COM
-

0 = product price in calculation - contact our office for pricing

PILOT

DESIGN Patrick Rampelotto & Fritz Pernkopf
2012



Quinze & milan



0 = product price in calculation - contact our office for pricing

PILOT COLLECTION

The design of the stool is based on traditional archetypes, their basic simplicity in form and function. The organically shade seat is supported by tapered legs made of oiled European oak. The seat itself is generously proportioned for comfort, its material tactile and contemporary. The ends of the legs are threaded and screwed into the seat, a connection that is both simple and sophisticated given the two very different materials of the joint.

Contact our sales office for more pricing options.



PILOT LOW STOOL

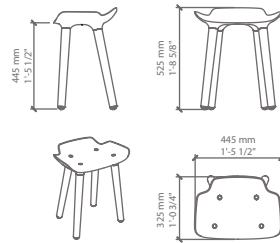

Pilot stool PPE + oak legs

Pilot low stool outdoor PPE + acacia legs



PILOT KITCHEN STOOL

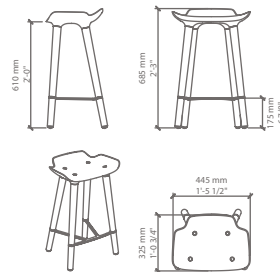

Pilot kitchen stool PPE + oak legs

Pilot kitchen outdoor PPE + acacia legs



PILOT BAR STOOL

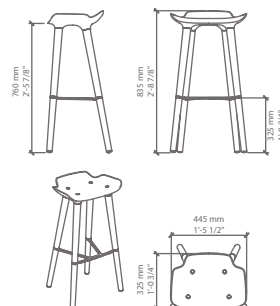

Pilot bar stool PPE + oak legs

Pilot bar stool outdoor PPE + acacia legs

0 = product price in calculation - contact our office for pricing

PILOT COLLECTION

The design of the stool is based on traditional archetypes, their basic simplicity in form and function. The organically shade seat is supported by tapered legs made of oiled European oak. The seat itself is generously proportioned for comfort, its material tactile and contemporary. The ends of the legs are threaded and screwed into the seat, a connection that is both simple and sophisticated given the two very different materials of the joint.

Contact our sales office for more pricing options.



PILOT LOW TABLE

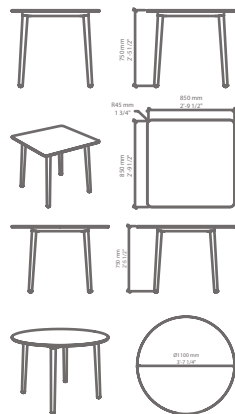

- Pilot table square 85 x 85cm HPL top + oak legs
- Pilot table square 85 x 85cm outdoor HPL top + acacia legs
- Pilot table round diam. 110cm HPL top + oak legs
- Pilot table round diam. 110cm outdoor HPL top + acacia legs



PILOT KITCHEN/BAR TABLE

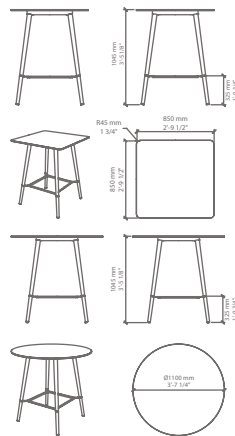

- Pilot kitchen/bar table 85 x 85cm HPL top + oak legs
- Pilot kitchen/bar table 85 x 85cm outdoor HPL top + acacia legs
- Pilot kitchen/bar table round HPL top + oak legs
- Pilot kitchen/bar table round outdoor HPL top + acacia legs

PILOT SIDE TABLE



- Pilot sidetable low + oak legs
- Pilot sidetable High + oak legs
- Pilot sidetable high/low mpX laminated MPX laminated + oak legs
- Pilot sidetable high/low oak finish + oak legs
- Pilot sidetable high/low oak finish fishbone MPX laminated + oak legs

0 = product price in calculation - contact our office for pricing

PODIUM SEAT

DESIGN SAQ

2016



0 = product price in calculation - contact our office for pricing

PODIUM SEAT

DESIGN SAQ

2016



PODIUM SEAT HIGH backrest



Podiumseat high QM Foam skin

Podiumseat high QM Plus foamskin double

Podiumseat high QM Tex foamskin Tex

PODIUM SEAT LOW backrest

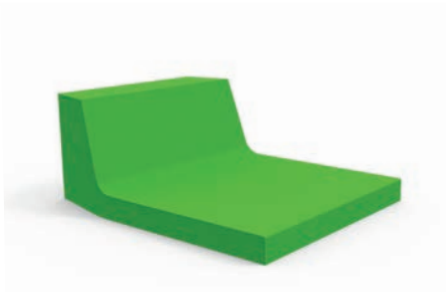

Podiumseat low QM Foam skin

Podiumseat low QM Plus foamskin double

QMTex Podiumseat Low

0 = product price in calculation - contact our office for pricing

PRIMARY
DESIGN SAQ
1999



Quinze & milan



“Our designs are never the end of a thought process,
but the beginning of a dialogue, an exchange of ideas.”

Primary Pouf was honored with some of the most prestigious global design awards.

0 = product price in calculation - contact our office for pricing

PRIMARY DESIGN SAQ 1999



Quinze & milan

Stripped to the essence, PRIMARY is the first comprehensive Quinze & Milan collection and a line that deserves to be called a Quinze & Milan classic.

The pieces in this collection include stools with and without legs (POUF 01, POUF 02, POUF 03 AND POUF 04); one-, two-, three- and four-seater settees (SOLO, DUO, TRIO and QUATTRO); and a chaise longue (LOUNGE).

Soft materials and a simple design language are a tried-and-true formula for a happy marriage. Not only did POUF 01 receive a triple Henry van de Velde Award (Belgium, 2001), but the sassy character of this comfortable, water-repellent collection has made it a hit worldwide: look for PRIMARY in prestigious public spaces from San Francisco and Detroit to Cannes and Porto. The pieces in this collection also lend themselves to residential projects.

PRIMARY is also available upholstered in leather and fabric. Custom color or sizes are available upon request.



PRIMARY POUF 01



- Primary Pouf 01 QM Foam skin
- Primary Pouf 01 QM Plus foamskin double
- Primary Pouf 01 QM Tex foamskin Tex
- Primary Pouf 01 QM CAT 1
- Primary Pouf 01 QM CAT 2
- Primary Pouf 01 QM CAT 0/COM



PRIMARY POUF 02



- Primary Pouf 02 QM Foam skin
- Primary Pouf 02 QM Plus foamskin double
- Primary Pouf 02 QM Tex foamskin Tex
- Primary Pouf 02 QM CAT 1
- Primary Pouf 02 QM CAT 2
- Primary Pouf 02 QM CAT 0/COM



PRIMARY POUF 03



- Primary Pouf 03 QM Foam skin
- Primary Pouf 03 QM Plus foamskin double
- Primary Pouf 03 QM Tex foamskin Tex
- Primary Pouf 03 QM CAT 1
- Primary Pouf 03 QM CAT 2
- Primary Pouf 03 QM CAT 0/COM



PRIMARY POUF 04 / NATURAL OAK LEGS



- Primary Pouf 04 QM Foam skin
- Primary Pouf 04 QM Plus foamskin double
- Primary Pouf 04 QM Tex foamskin Tex
- Primary Pouf 04 QM CAT 1
- Primary Pouf 04 QM CAT 2
- Primary Pouf 04 QM CAT 0/COM



PRIMARY POUF 05

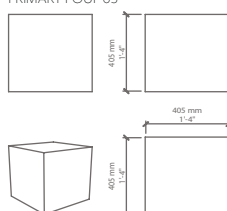

- Primary Pouf 05 QM Foam skin
- Primary Pouf 05 QM Plus foamskin double
- Primary Pouf 05 QM Tex foamskin Tex
- Primary Pouf 05 QM CAT 1
- Primary Pouf 05 QM CAT 2
- Primary Pouf 05 QM CAT 0/COM

0 = product price in calculation - contact our office for pricing

Considering the amount of projects with different sized mirror- and wall solutions (straight back), and with corners more standard solutions have been added. The straight back versions and the corners can easily be placed against the wall.

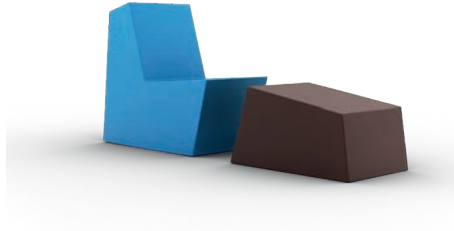

PRIMARY SOLO

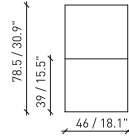
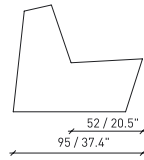

SOLO VARIATIONS



SOLO STRAIGHT BACK



SOLO MIRROR

- Primary Solo QM Foam skin
- Primary Solo QM Plus foamskin double
- Primary Solo QM Tex foamskin Tex
- Primary Solo QM CAT 1
- Primary Solo QM CAT 2
- Primary Solo QM CAT 0/COM
- Primary solo straight back QM Foam skin
- Primary solo straight back QM Plus foamskin double
- Primary solo straight back QM Tex foamskin Tex
- Primary solo straight back QM CAT 1
- Primary solo straight back QM CAT 2
- Primary solo straight back QM CAT 0/COM
- Primary solo mirror QM Foam skin
- Primary solo mirror QM Plus foamskin double
- Primary solo mirror QM Tex foamskin Tex
- Primary solo mirror QM CAT 1
- Primary solo mirror QM CAT 2
- Primary solo mirror QM CAT 0/COM



PRIMARY SOLO OTTOMAN

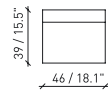
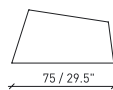

- Primary solo ottoman QM Foam skin
- Primary solo ottoman QM Plus foamskin double
- Primary solo ottoman QM Tex foamskin Tex
- Primary solo ottoman QM CAT 1
- Primary solo ottoman QM CAT 2
- Primary solo ottoman QM CAT 0/COM

PRIMARY DUO

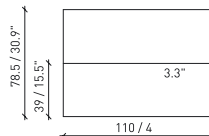
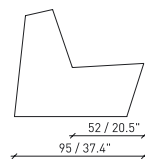

DUO VARIATIONS



DUO STRAIGHT BACK



DUO MIRROR

- Primary duo QM Foam skin
- Primary duo QM Plus foamskin double
- Primary duo QM Tex foamskin Tex
- Primary duo QM CAT 1
- Primary duo QM CAT 2
- Primary duo QM CAT 0/COM
- Primary duo straight back QM Foam skin
- Primary duo straight back QM Plus foamskin double
- Primary duo straight back QM Tex foamskin Tex
- Primary duo straight back QM CAT 1
- Primary duo straight back QM CAT 2
- Primary duo straight back QM CAT 0/COM
- Primary duo mirror QM Foam skin
- Primary duo mirror QM Plus foamskin double
- Primary duo mirror QM Tex foamskin Tex
- Primary duo mirror QM CAT 1
- Primary duo mirror QM CAT 2
- Primary duo mirror QM CAT 0/COM

0 = product price in calculation - contact our office for pricing

PRIMARY
DESIGN SAQ
1999



Quinze & milan



PRIMARY TRIO

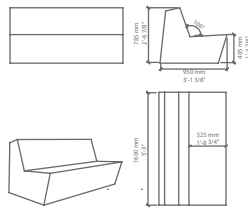

TRIO VARIATIONS

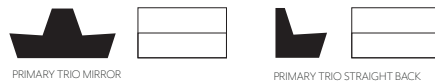

PRIMARY TRIO MIRROR

PRIMARY TRIO STRAIGHT BACK

- Primary trio QM Foam skin
- Primary trio QM Plus foamskin double
- Primary trio QM Tex foamskin Tex
- Primary trio QM CAT 1
- Primary trio QM CAT 2
- Primary trio QM CAT 0/COM
- Primary trio straight back QM Foam skin
- Primary trio straight back QM Plus foamskin double
- Primary trio straight back QM Tex foamskin Tex
- Primary trio straight back QM CAT 1
- Primary trio straight back QM CAT 2
- Primary trio straight back QM CAT 0/COM
- Primary trio mirror QM Foam skin
- Primary trio mirror QM Plus foamskin double
- Primary trio mirror QM Tex foamskin Tex
- Primary trio mirror QM CAT 1
- Primary trio mirror QM CAT 2
- Primary trio mirror QM CAT 0/COM



PRIMARY QUATTRO

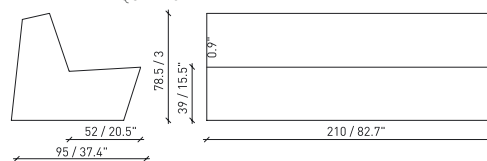

QUATTRO VARIATIONS

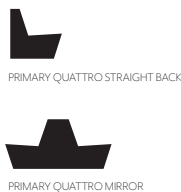

PRIMARY QUATTRO STRAIGHT BACK

PRIMARY QUATTRO MIRROR

- Primary quattro QM Foam skin
- Primary quattro QM Plus foamskin double
- Primary quattro QM Tex foamskin Tex
- Primary quattro QM CAT 1
- Primary quattro QM CAT 2
- Primary quattro QM CAT 0/COM
- Primary quattro straight back QM Foam skin
- Primary quattro straight back QM Plus foamskin double
- Primary quattro straight back QM Tex foamskin Tex
- Primary quattro straight back QM CAT 1
- Primary quattro straight back QM CAT 2
- Primary quattro straight back QM CAT 0/COM
- Primary quattro mirror QM Foam skin
- Primary quattro mirror QM Plus foamskin double
- Primary quattro mirror QM Tex foamskin Tex
- Primary quattro mirror QM CAT 1
- Primary quattro mirror QM CAT 2
- Primary quattro mirror QM CAT 0/COM



PRIMARY LOUNGE

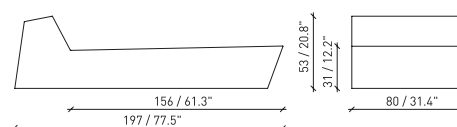

- Primary lounge QM Foam skin
- Primary lounge QM Plus foamskin double
- Primary lounge QM Tex foamskin Tex
- Primary lounge QM CAT 1
- Primary lounge QM CAT 2
- Primary lounge QM CAT 0/COM

0 = product price in calculation - contact our office for pricing

QUARTZ
DESIGN QUINZE & MILAN
2007



Quinze & milan



0 = product price in calculation - contact our office for pricing

QUARTZ

DESIGN QUINZE & MILAN

2007



Quinze & milan

Quinze & Milan tackles geometry once again and has furthered its work on forms and faceting, seeking new effects from the wood and creating a chair whose design is a combination of the past and future. Using the most classic of materials, Quinze & Milan has successfully made an object with a symbolic shape in which the material gains qualities of luminosity.

Quartz is an object of the future that retains the intrinsic value of wood - strong and hard-wearing, comfortable and basic. "We wanted to give the material a different look without however ignoring its natural qualities. The facets give a dynamic and vibrant appeal, while the surface plays with the light, creating a sparkling effect. Just like Quartz.



QUARTZ CHAIR

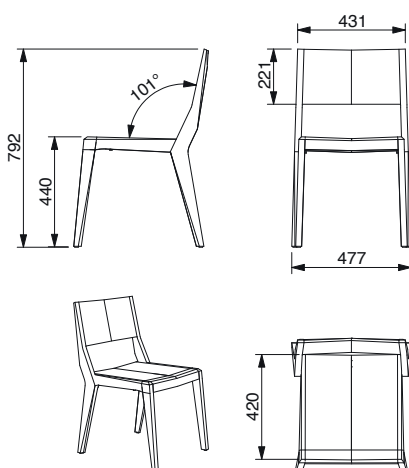

Quartz Chair black

0 = product price in calculation - contact our office for pricing

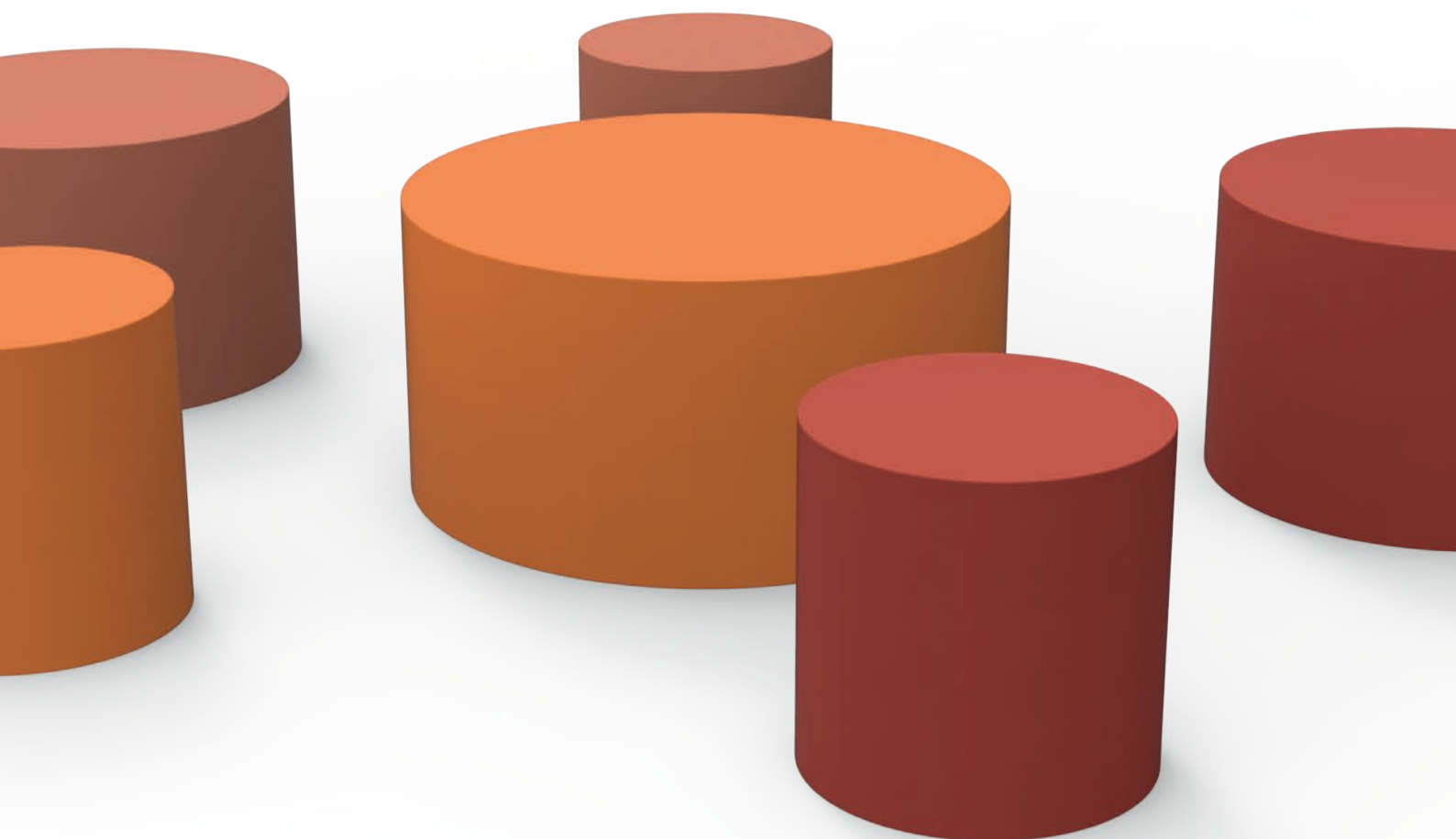

0 = product price in calculation - contact our office for pricing

RONDO IS THE NEW SIZABLE CILLINDAR BLOCK.

Sizable in width, depth and height.

We offer some standard sizes but these blocks can easily be customized in all directions.

We offer some standard sizes for your convenience; keeping a standard seating height from 47,5cm and depth 47,5cm the standard steps are 95 - 142,5 - 190cm

Round 01 starts from w95 x D 47,5 x h 47,5

Round 02 is then w142,5 x d47,5 x h 47,5

Round 03 is w190 x d47,5 x h47,5cm

Of course you can add your specific size to the blocks, keeping the base shape rectangular and seating height at 47,5cm

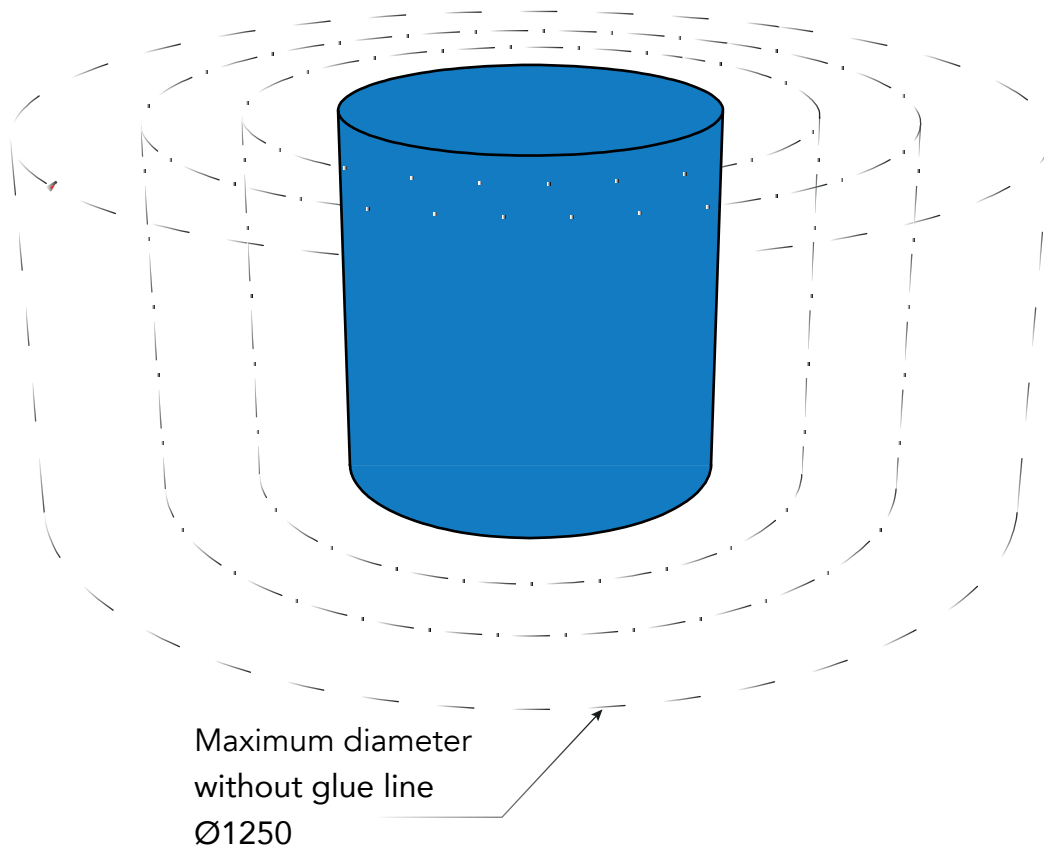



RONDO 01

Ø 47,5cm
Height 47,5 cm

Rondo - 01 - QM Foam skin

Rondo - 01 - QM Plus foamskin double

Rondo - 01 - QM Tex foamskin Tex

Rondo - 01 - fabric CAT 0/COM

Rondo - 01 - fabric CAT 1

Rondo - 01 - fabric CAT 2

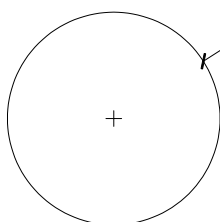
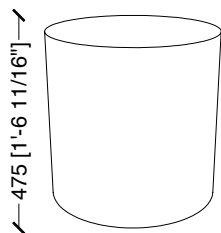

RONDO 02

Ø 71cm
Height 47,5cm

Rondo - 02 - QM Foam skin

Rondo - 02 - QM Plus foamskin double

Rondo - 02 - QM Tex foamskin Tex

Rondo - 02 - fabric CAT 0/COM

Rondo - 02 - fabric CAT 1

Rondo - 02 - fabric CAT 2

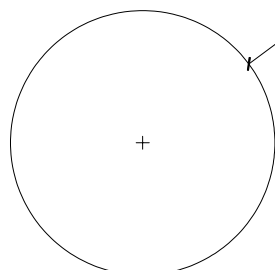
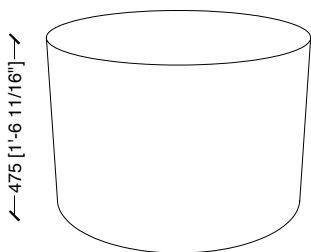

RONDO 03

Ø 95cm
Height 47,5cm

Rondo - 03 - QM Foam skin

Rondo - 03 - QM Plus foamskin double

Rondo - 03 - QM Tex foamskin Tex

Rondo - 03 - fabric CAT 0/COM

Rondo - 03 - fabric CAT 1

Rondo - 03 - fabric CAT 2

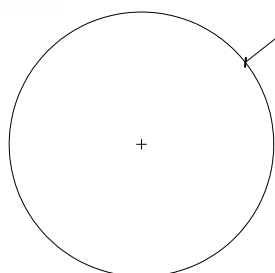
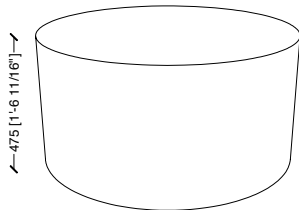

ROOM 26

DESIGN QUINZE & MILAN

2004



*Quinze & milan*TM



0 = product price in calculation - contact our office for pricing

ROOM 26

DESIGN QUINZE & MILAN 2004



Quinze & milan™

ROOM 26 has a look that fuses the familiar and the timeless with 'something different', offering an extensive range of products that can transform an interior into a space that shouts '26' or, when used sparingly, can conjure up a room that barely whispers the word.

Key to the collection is oak, a material playfully combined with fabric, leather or foamskin cushions.

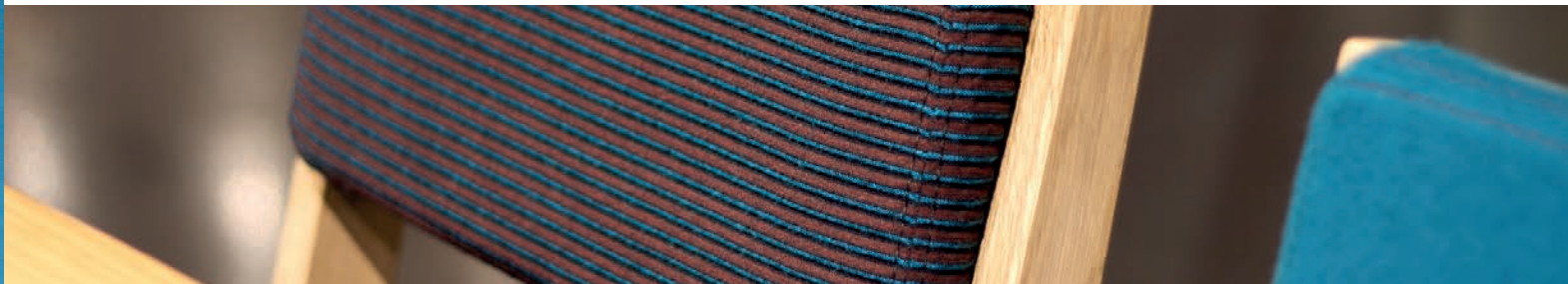

ROOM 26 CHAIR 01

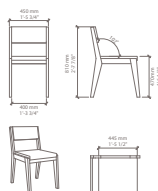

ROOM 26 CHAIR 02

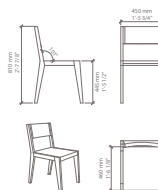

ROOM 26 CHAIR 04

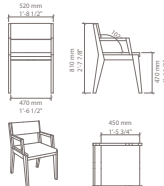

ROOM 26 SEAT 01

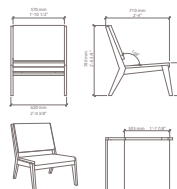

ROOM 26 CHAIR - AMPHI

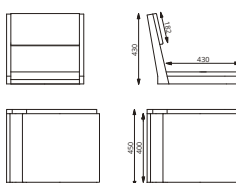

0 = product price in calculation - contact our office for pricing

ROUND CAKE

DESIGN DISSING+WEITLING

2008



Quinze & milan



0 = product price in calculation - contact our office for pricing

ROUND CAKE

DESIGN DISSING+WEITLING

2008



Quinze & milan



Round was originally designed for the University Library, a part of the Danish Royal Library, Copenhagen. Round was created to cater for easy socializing in the lounge areas. By composing the various basic elements it is easy to create a relaxed landscape of seating and socializing possibilities. The new humanities faculty library offers the students a well designed, functional library building designed with singular focus on creating the optimum facility based on users' needs. The architects from Dissing+Weitling's project group have liaised closely throughout the entire process with a user group of Royal Library employees.

ROUND CAKE is also available upholstered in leather and fabric.
Custom color or sizes are available upon request.

CAKE



Ø 180cm
Seating height 42cm
Total height 67cm

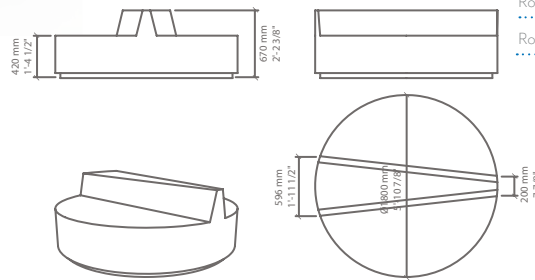

- Round Cake QM Foam skin
- Round Cake QM Plus foamskin double
- Round Cake QM Tex foamskin Tex
- Round Cake QM CAT 1
- Round Cake QM CAT 2
- Round Cake QM CAT 0/COM

HALF CAKE



Ø 180cm
Seating height 42cm
Total height 67cm

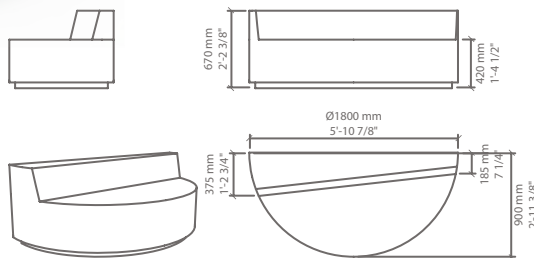

- Round half cake QM Foam skin
- Round half cake QM Plus foamskin double
- Round half cake QM Tex foamskin Tex
- Round half cake QM CAT 1
- Round half cake QM CAT 2
- Round half cake QM CAT 0/COM

0 = product price in calculation - contact our office for pricing

RPBW - Athens collection

DESIGN RENZO PIANO BUILDING WORKSHOP

2016



0 = product price in calculation - contact our office for pricing

RPBW - Athens collection

DESIGN RENZO PIANO BUILDING WORKSHOP

2016



RPBW

SDC lab worked in close partnership with the staff of the Renzo Piano Building Workshop from Paris in order to develop tailor made furniture.

The result is a number of timeless pieces for special areas in libraries or museums.

Contact our sales office for more pricing options.



RPBW sofa ottoman

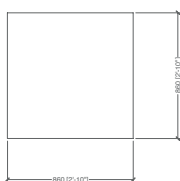

RPBW - Sofa ottoman - QM Foam skin

RPBW - Sofa ottoman - QM Plus foamskin double

RPBW - Sofa ottoman - QM Tex foamskin Tex

RPBW - Sofa ottoman - fabric CAT 1

RPBW - Sofa ottoman - fabric CAT 2

RPBW - Sofa ottoman - fabric CAT 0/COM

RPBW sofa straight

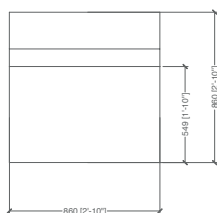
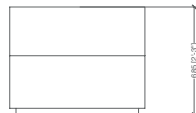
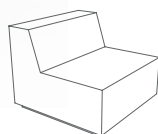
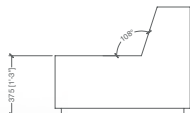

RPBW - Sofa straight - QM Foam skin

RPBW - Sofa straight - QM Plus foamskin double

RPBW - Sofa straight - QM Tex foamskin Tex

RPBW - Sofa straight - fabric CAT 1

RPBW - Sofa straight - fabric CAT 2

RPBW - Sofa straight - fabric CAT 0/COM

RPBW sofa corner

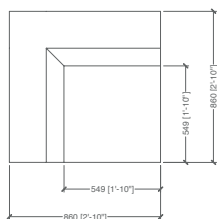
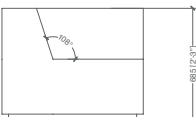
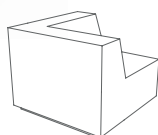
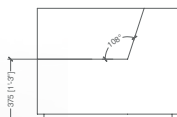

RPBW - Sofa corner - QM Foam skin

RPBW - Sofa corner - QM Plus foamskin double

RPBW - Sofa corner - QM Tex foamskin Tex

RPBW - Sofa corner - fabric CAT 1

RPBW - Sofa corner - fabric CAT 2

RPBW - Sofa corner - fabric CAT 0/COM

0 = product price in calculation - contact our office for pricing

RPBW - Athens collection

DESIGN RENZO PIANO BUILDING WORKSHOP

2016



RPBW sofa armchair

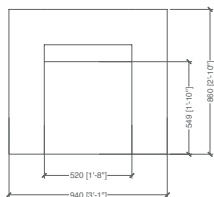
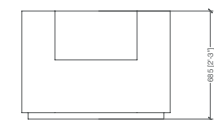
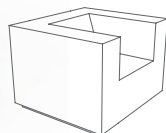
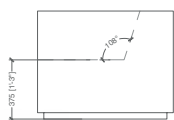
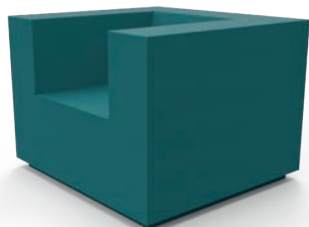

..... RPBW - Sofa armchair - QM Foam skin

..... RPBW - Sofa armchair - QM Plus foamskin double

..... RPBW - Sofa armchair - QM Tex foamskin Tex

..... RPBW - Sofa armchair - fabric CAT 1

..... RPBW - Sofa armchair - fabric CAT 2

..... RPBW - Sofa armchair - fabric CAT 0/COM

RPBW sofa armchair large

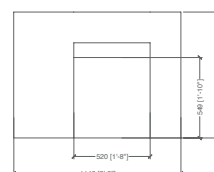
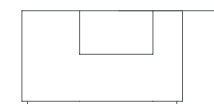
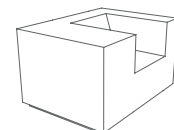
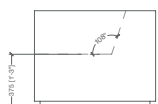
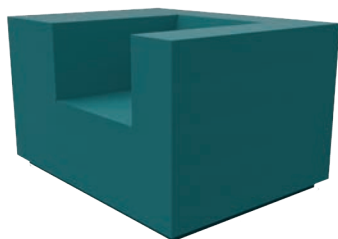

..... RPBW - Sofa armchair large - QM Foam skin

..... RPBW - Sofa armchair large - QM Plus foamskin double

..... RPBW - Sofa armchair large - QM Tex foamskin Tex

..... RPBW - Sofa armchair large - fabric CAT 1

..... RPBW - Sofa armchair large - fabric CAT 2

..... RPBW - Sofa armchair large - fabric CAT 0/COM

0 = product price in calculation - contact our office for pricing

RPBW - Athens collection

DESIGN RENZO PIANO BUILDING WORKSHOP

2016

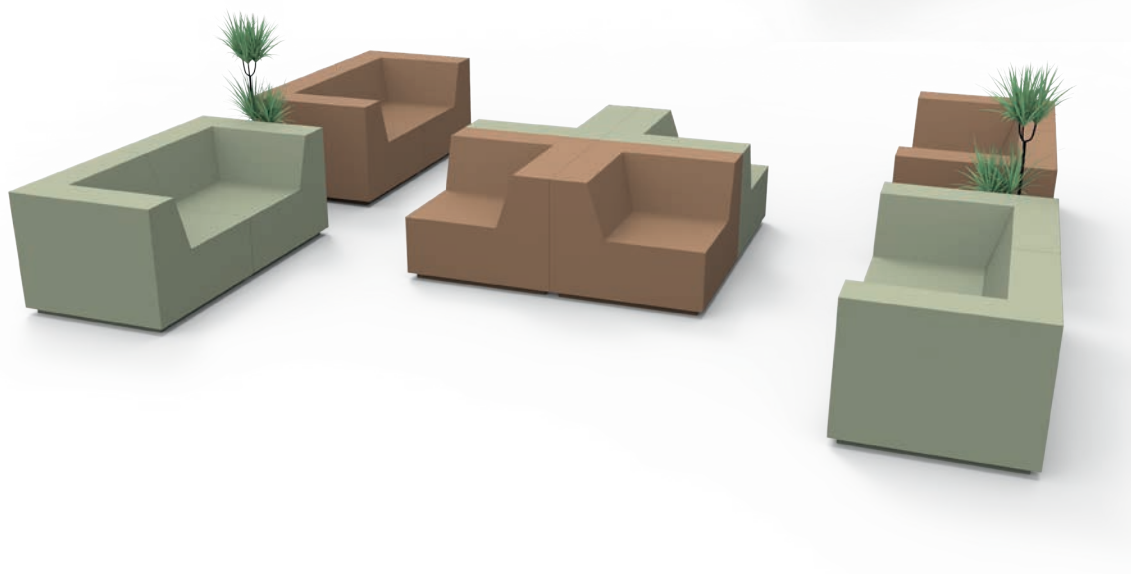
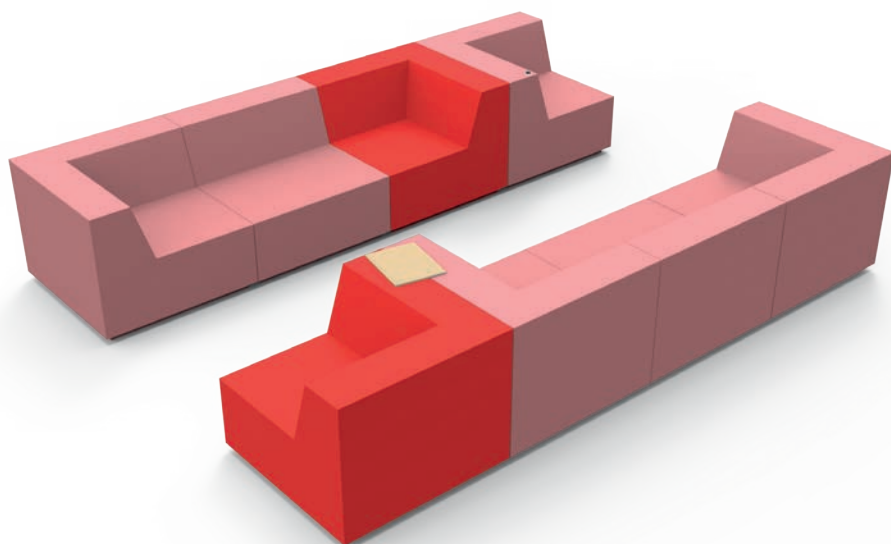

0 = product price in calculation - contact our office for pricing

SCONE

DESIGN KAZUKO OKAMOTO

2018

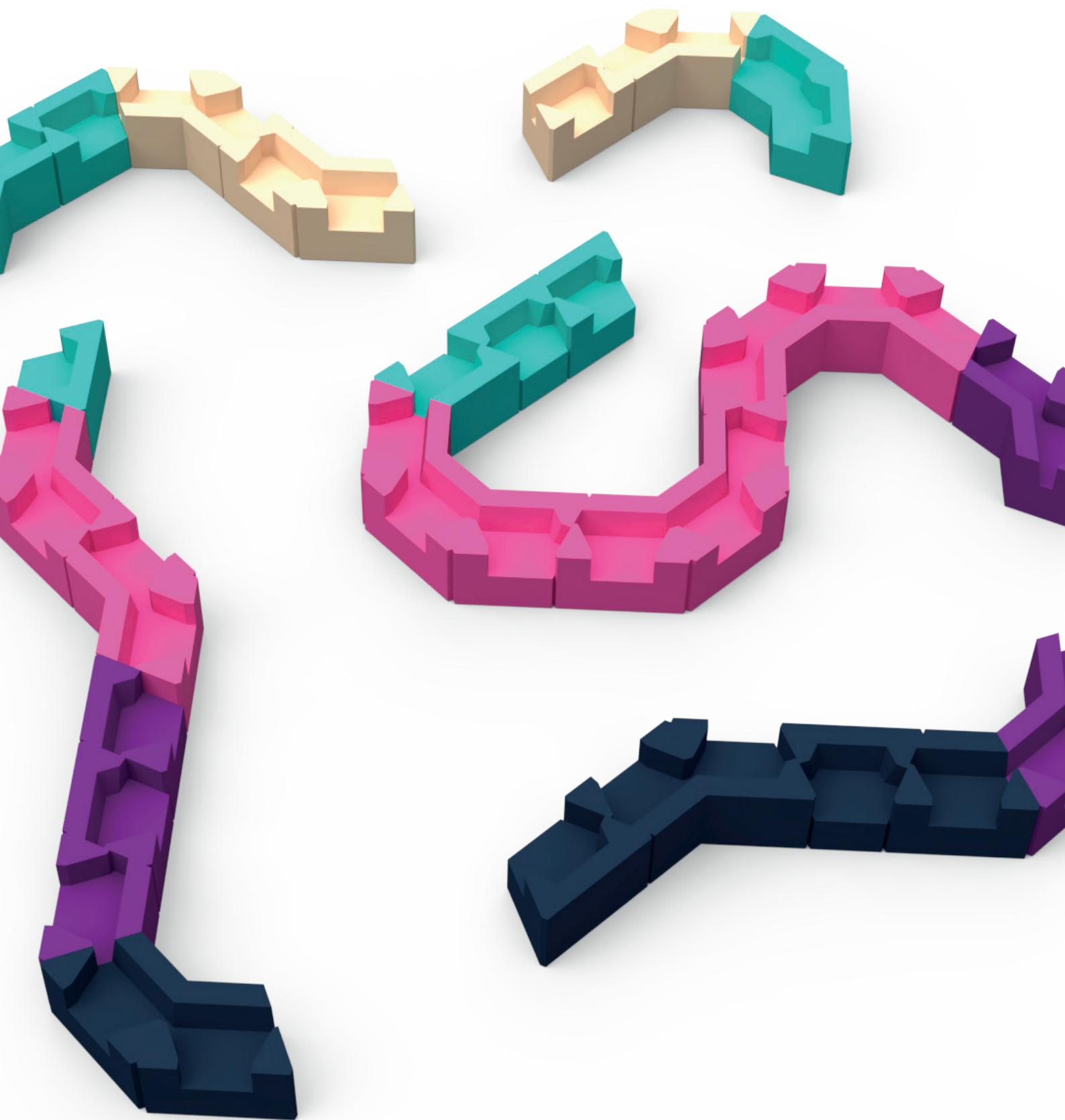

0 = product price in calculation - contact our office for pricing

SCONE is a thrilling modular sofa designed by Kazuko Okamoto, a Japanese designer with her roots in Japan. Scone is a design idea that gives you the possibility to combine, turn, create unexpected twists to your project.

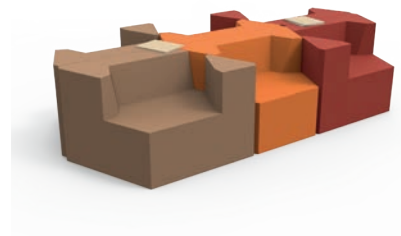
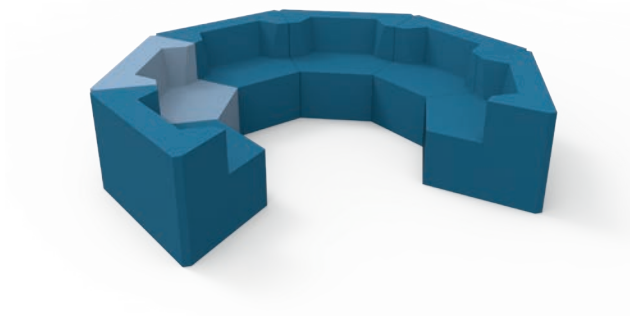

SCONE narrow

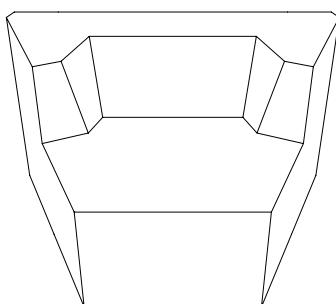

SCONE - narrow no arm - QM Foam skin

SCONE - narrow no arm - QM Plus foamskin double

SCONE wide

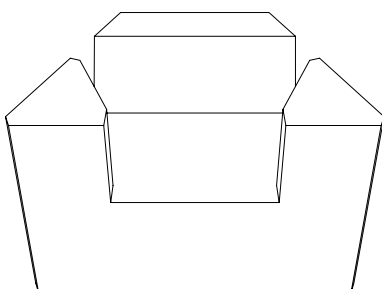
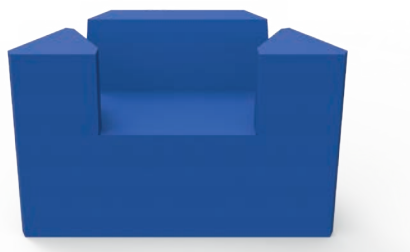

SCONE - wide double arm - QM Foam skin

SCONE - wide double arm - QM Plus foamskin double

SCONE left & right

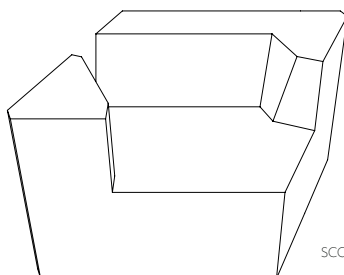

SCONE left

SCONE - left - QM Foam skin

SCONE - left - QM Plus foamskin double

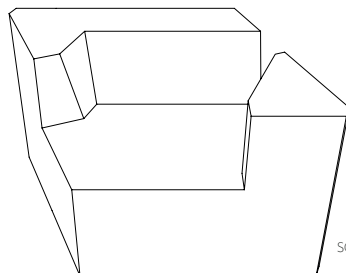
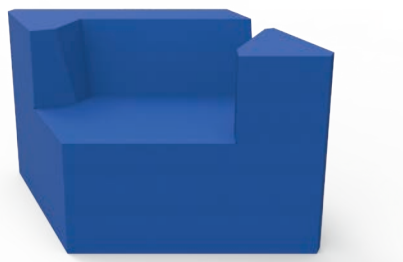

SCONE right

SCONE - right - QM Foam skin

SCONE - right - QM Plus foamskin double

0 = product price in calculation - contact our office for pricing

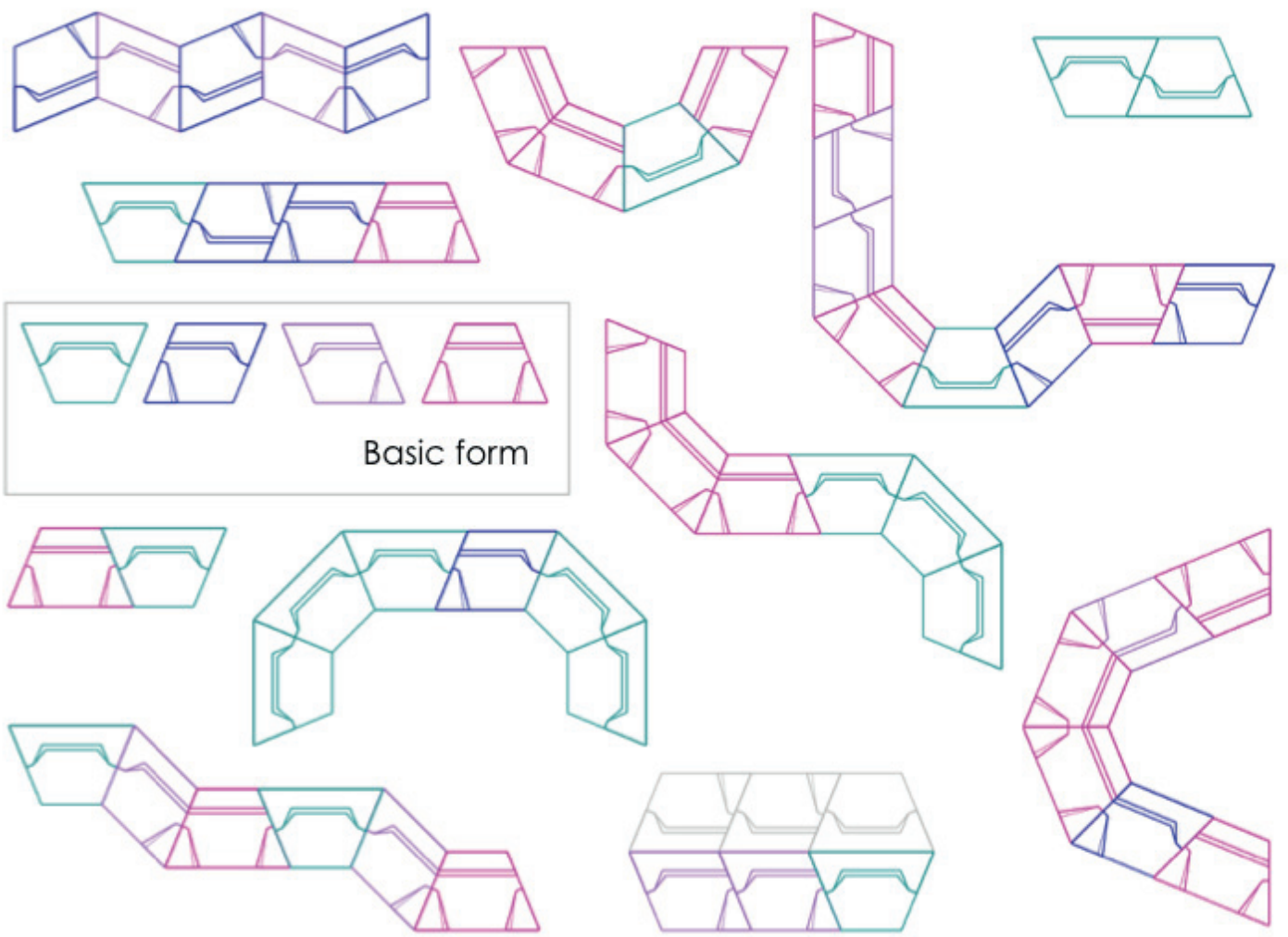
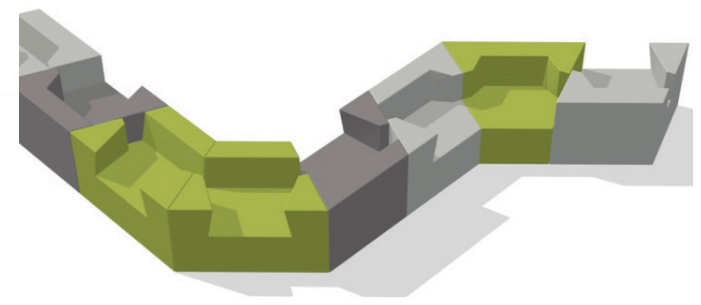
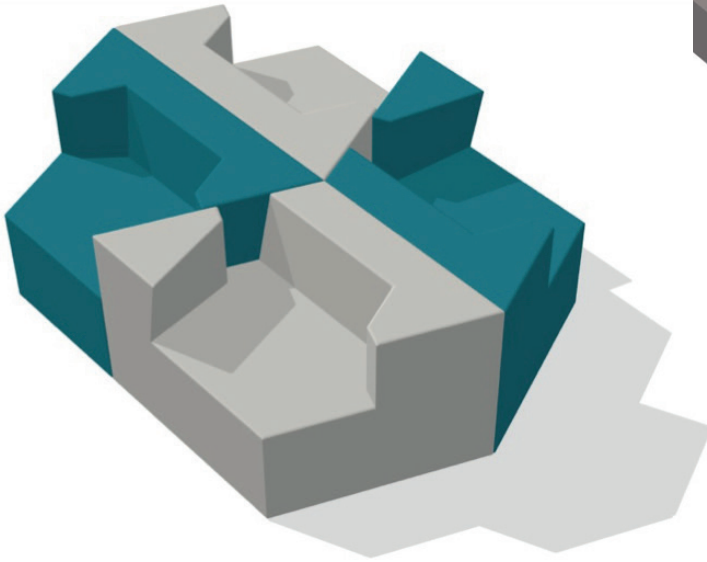

Basic form

0 = product price in calculation - contact our office for pricing

SEATTLE CROSS
DESIGN SCOTT WILSON
2004



Quinze & milan



0 = product price in calculation - contact our office for pricing

SEATTLE CROSS DESIGN SCOTT WILSON 2004



Quinze & milan



OMA (Office for Metropolitan Architecture) commissioned Quinze & Milan to furnish the Seattle Public Library, a project for which the seating system had to comply with the strict standards of the ISDA.

SEATTLE CROSS is also available upholstered in leather and fabric.

Custom color or sizes are available upon request.

SEATTLE CROSS 01

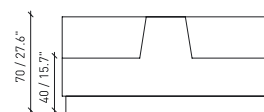
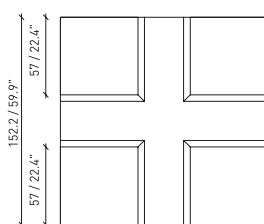
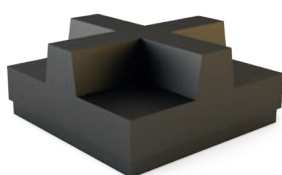

Seattle cross 01 QM Foam skin

Seattle cross 01 QM Plus foamskin double

Seattle cross 01 QM Tex foamskin Tex

Seattle cross 01 QM CAT 1

Seattle cross 01 QM CAT 2

Seattle cross 01 QM CAT 0/COM

> TOPVIEW VARIATIONS

PRICING OF THESE VARIATIONS IS IDENTICAL AS SEATTLE CROSS 01



02

Seattle cross 02 QM Foam skin

Seattle cross 02 QM Plus foamskin double

Seattle cross 02 QM Tex foamskin Tex

Seattle cross 02 QM CAT 1

Seattle cross 02 QM CAT 2

Seattle cross 02 QM CAT 0/COM

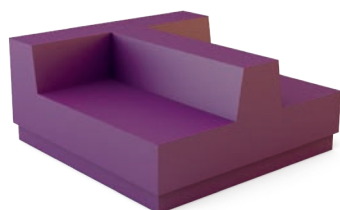

03

Seattle cross 03 QM Foam skin

Seattle cross 03 QM Plus foamskin double

Seattle cross 03 QM Tex foamskin Tex

Seattle cross 03 QM CAT 1

Seattle cross 03 QM CAT 2

Seattle cross 03 QM CAT 0/COM

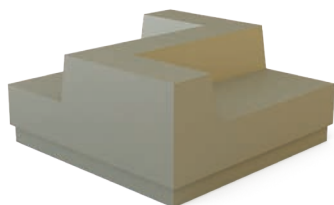

04

Seattle cross 04 QM Foam skin

Seattle cross 04 QM Plus foamskin double

Seattle cross 04 QM Tex foamskin Tex

Seattle cross 04 QM CAT 1

Seattle cross 04 QM CAT 2

Seattle cross 04 QM CAT 0/COM

0 = product price in calculation - contact our office for pricing

SHAPES & CURVES

DESIGN SDC_lab

2016

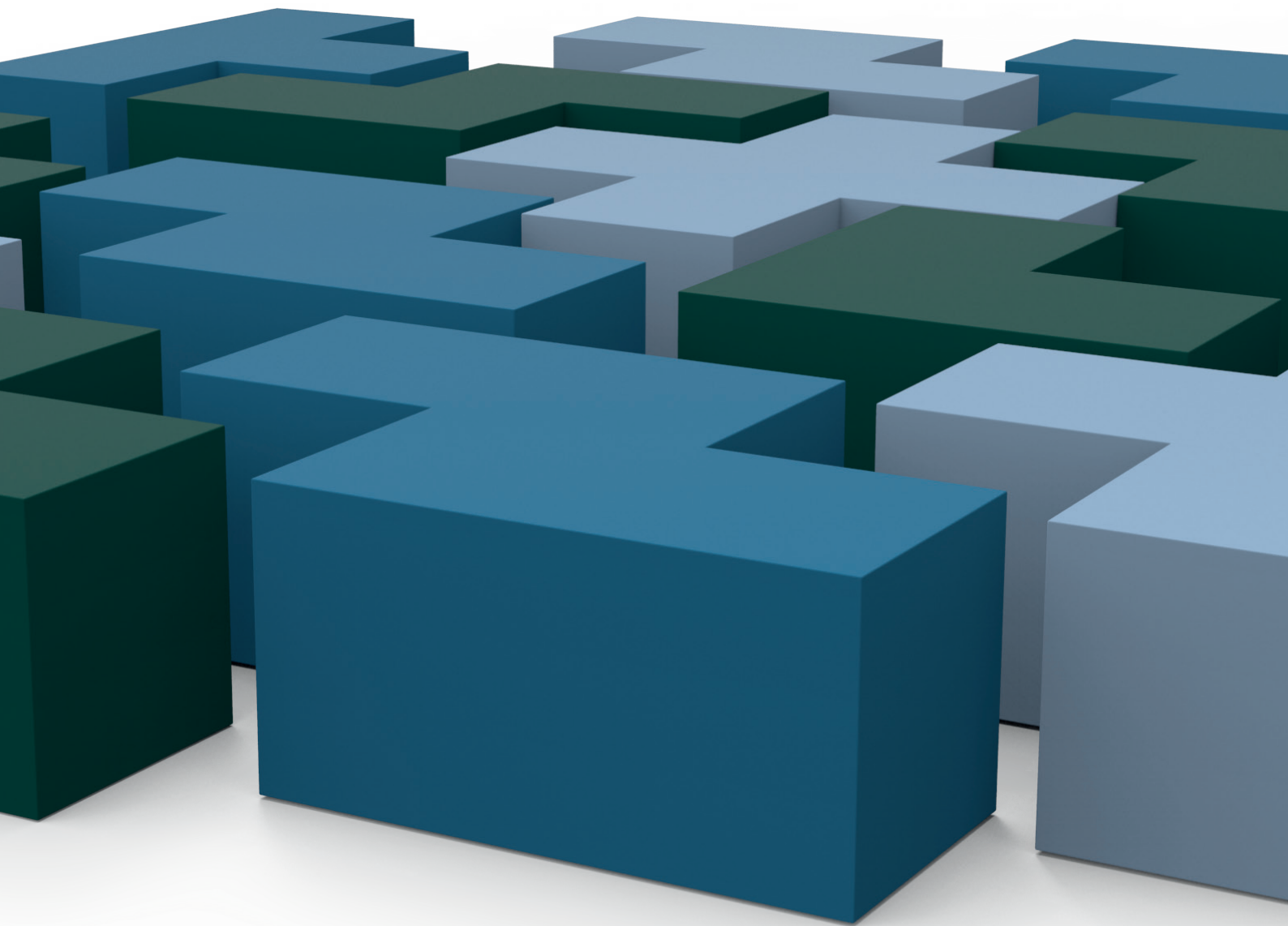

0 = product price in calculation - contact our office for pricing

SHAPES & CURVES

DESIGN SDC lab

2016



S SHAPE

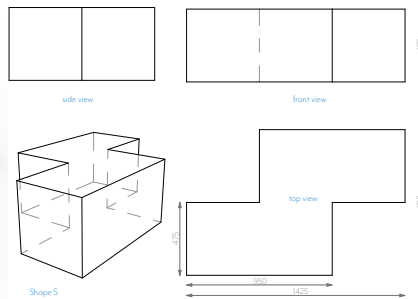
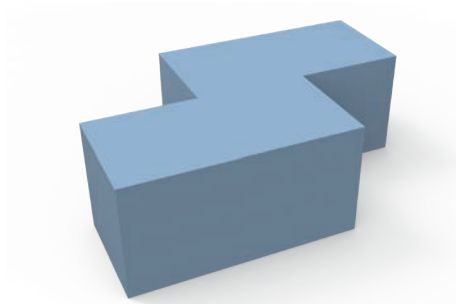

- Shapes - S-shape - QM Foam skin
- Shapes - S-shape - QM Plus foamskin double
- Shapes - S-shape - QM Tex foamskin Tex
- Shapes - S-shape - fabric CAT 1
- Shapes - S-shape - fabric CAT 2
- Shapes - S-shape - fabric CAT 0/COM

Z SHAPE

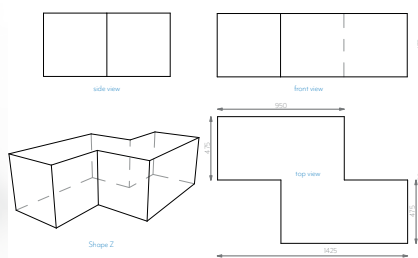
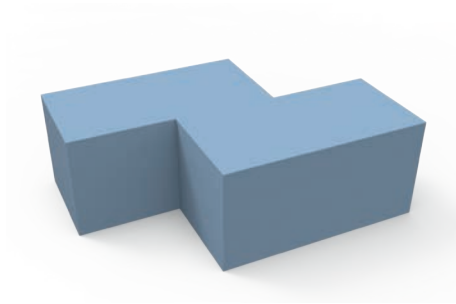

- Shapes - Z-shape - QM Foam skin
- Shapes - Z-shape - QM Plus foamskin double
- Shapes - Z-shape - QM Tex foamskin Tex
- Shapes - Z-shape - fabric CAT 1
- Shapes - Z-shape - fabric CAT 2
- Shapes - Z-shape - fabric CAT 0/COM

L SHAPE

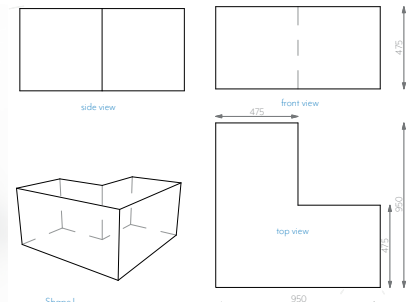
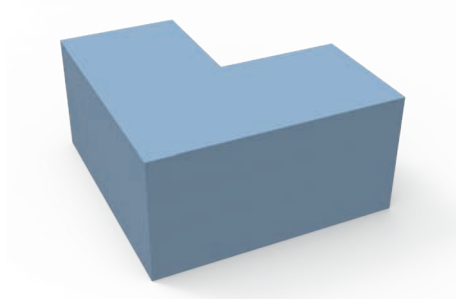

- Shapes - L-shape - QM Foam skin
- Shapes - L-shape - QM Plus foamskin double
- Shapes - L-shape - QM Tex foamskin Tex
- Shapes - L-shape - fabric CAT 1
- Shapes - L-shape - fabric CAT 2
- Shapes - L-shape - fabric CAT 0/COM

T SHAPE

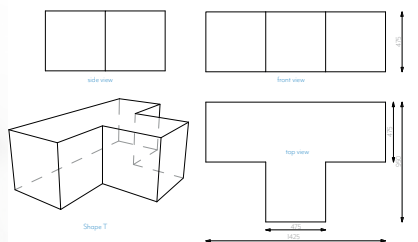
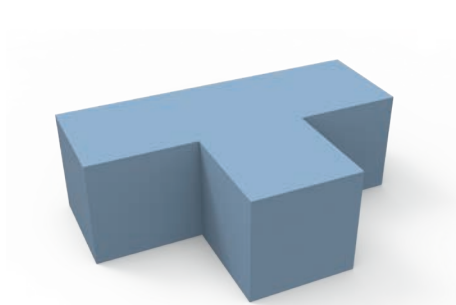

- Shapes - T-shape - QM Foam skin
- Shapes - T-shape - QM Plus foamskin double
- Shapes - T-shape - QM Tex foamskin Tex
- Shapes - T-shape - fabric CAT 1
- Shapes - T-shape - fabric CAT 2
- Shapes - T-shape - fabric CAT 0/COM

X SHAPE

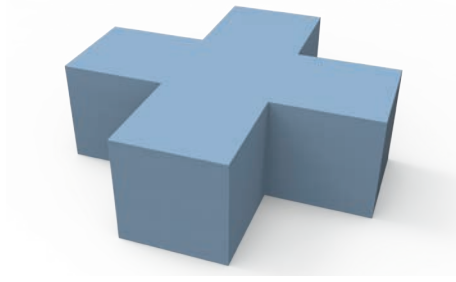

- Shapes - X-shape - QM Foam skin
- Shapes - X-shape - QM Plus foamskin double
- Shapes - X-shape - QM Tex foamskin Tex
- Shapes - X-shape - fabric CAT 1
- Shapes - X-shape - fabric CAT 2
- Shapes - X-shape - fabric CAT 0/COM

0 = product price in calculation - contact our office for pricing

PENTAGON SHAPE

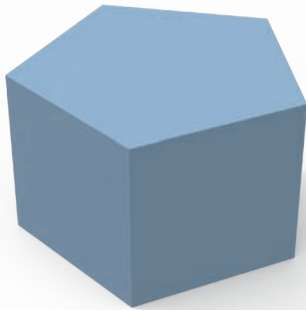

side view

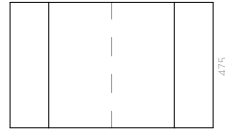

front view

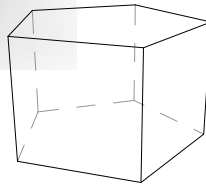

Shape Pentagon

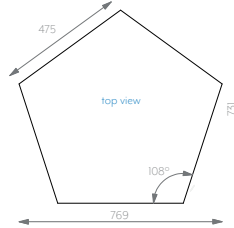

top view

-
- Shapes - Pentagon - QM Foam skin
- Shapes - Pentagon - QM Plus foamskin double
- Shapes - Pentagon - QM Tex foamskin Tex
- Shapes - Pentagon - fabric CAT 1
- Shapes - Pentagon - fabric CAT 2
- Shapes - Pentagon - fabric CAT 0/COM
-

HEXAGON SHAPE

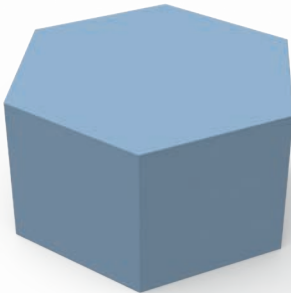

side view

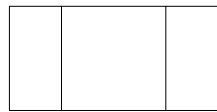

front view

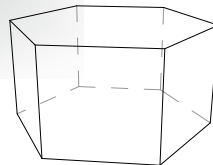

Shape Hexagon

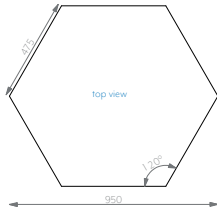

top view

-
- Shapes - Hexagon - QM Foam skin
- Shapes - Hexagon - QM Plus foamskin double
- Shapes - Hexagon - QM Tex foamskin Tex
- Shapes - Hexagon - fabric CAT 1
- Shapes - Hexagon - fabric CAT 2
- Shapes - Hexagon - fabric CAT 0/COM
-

TRIANGLE SHAPE

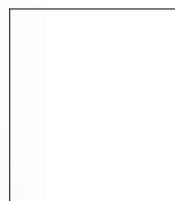
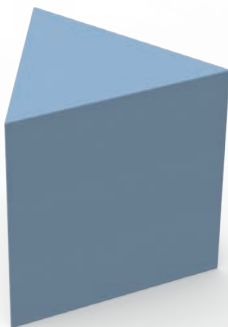

side view

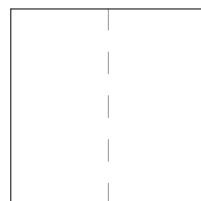

front view

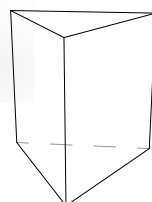

Shape Triangle

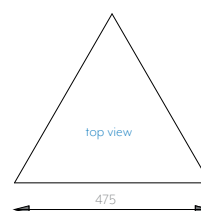

top view

-
- Shapes - Triangle - QM Foam skin
- Shapes - Triangle - QM Plus foamskin double
- Shapes - Triangle - QM Tex foamskin Tex
- Shapes - Triangle - fabric CAT 1
- Shapes - Triangle - fabric CAT 2
- Shapes - Triangle - fabric CAT 0/COM
-

0 = product price in calculation - contact our office for pricing

CURVE 90

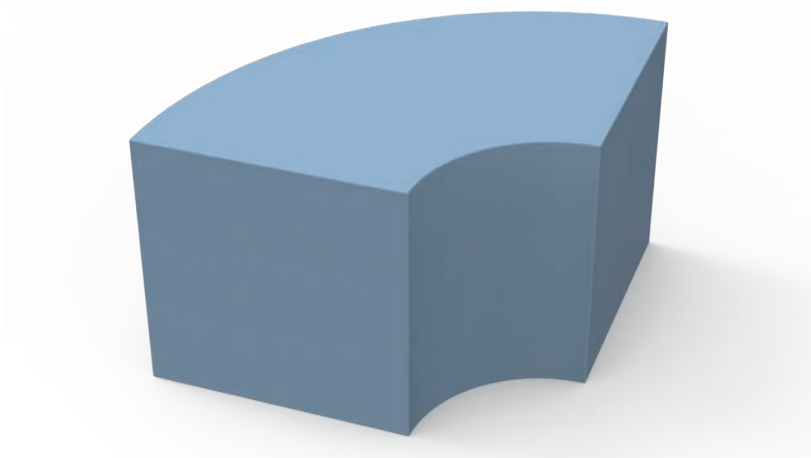

-
- Curves - Curve 90 - QM Foam skin
-
- Curves - Curve 90 - QM Plus foamskin double
-
- Curves - Curve 90 - QM Tex foamskin Tex
-
- Curves - Curve 90 - fabric CAT 0/COM
-
- Curves - Curve 90 - fabric CAT 1
-
- Curves - Curve 90 - fabric CAT 2
-

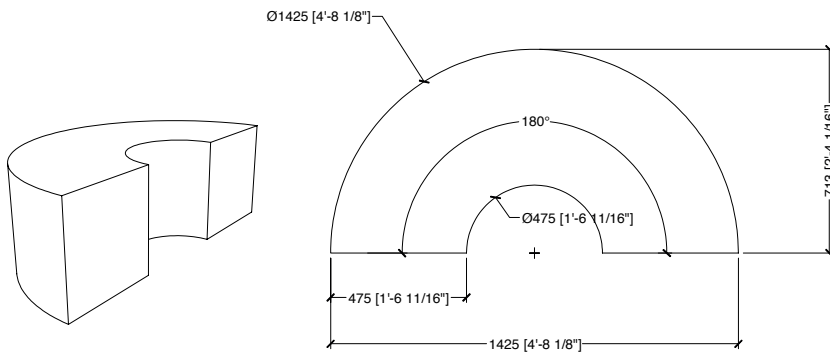

CURVE 180

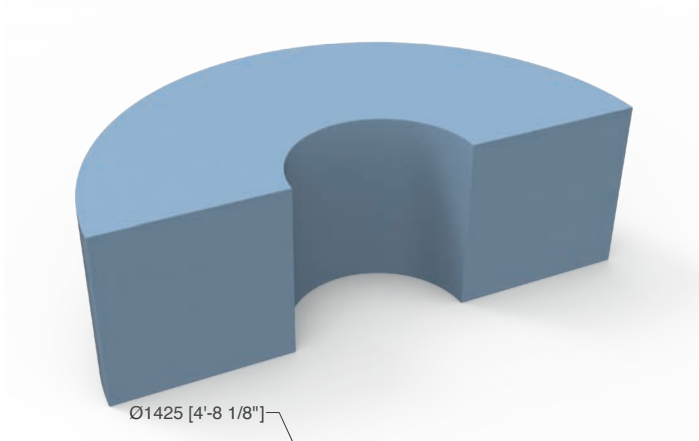

-
- Curves - Curve 180 - QM Foam skin
-
- Curves - Curve 180 - QM Plus foamskin double
-
- Curves - Curve 180 - QM Tex foamskin Tex
-
- Curves - Curve 180 - fabric CAT 0/COM
-
- Curves - Curve 180 - fabric CAT 1
-
- Curves - Curve 180 - fabric CAT 2
-

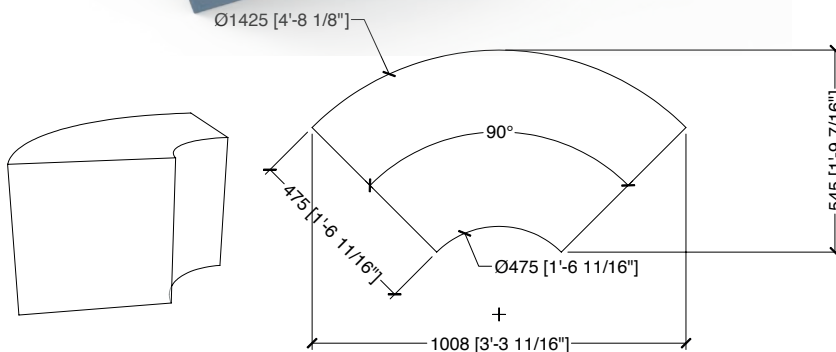

0 = product price in calculation - contact our office for pricing



0 = product price in calculation - contact our office for pricing

CURVE HALF ROUND

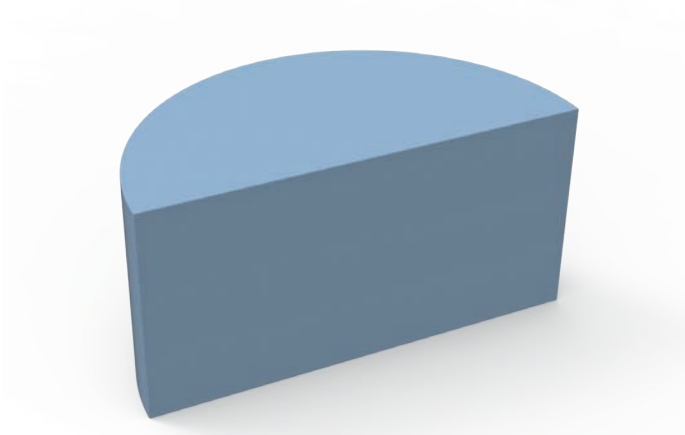

-
- Curves - half round - QM Foam skin
- Curves - half round - QM Plus foamskin double
- Curves - half round - QM Tex foamskin Tex
- Curves - half round - fabric CAT 0/COM
- Curves - half round - fabric CAT 1
- Curves - half round - fabric CAT 2
-

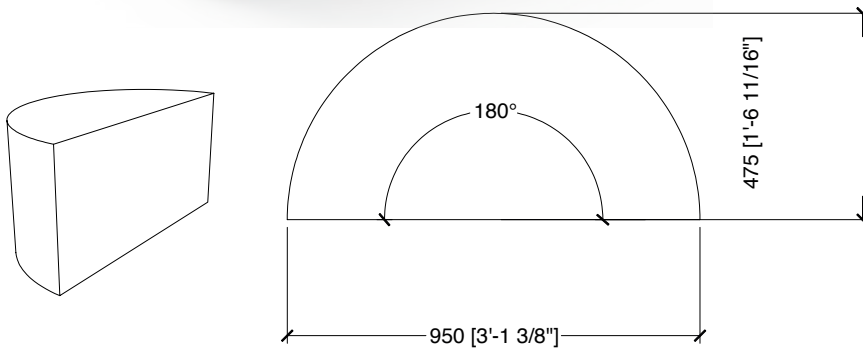

CURVE QUARTER R

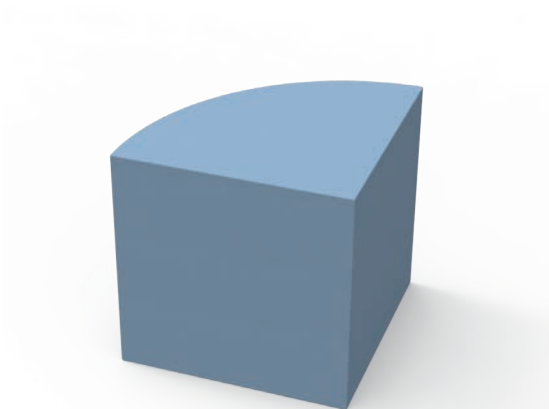

-
- Curves - quarter round - QM Foam skin
- Curves - quarter round - QM Plus foamskin double
- Curves - quarter round - QM Tex foamskin Tex
- Curves - quarter round - fabric CAT 0/COM
- Curves - quarter round - fabric CAT 1
- Curves - quarter round - fabric CAT 2
-

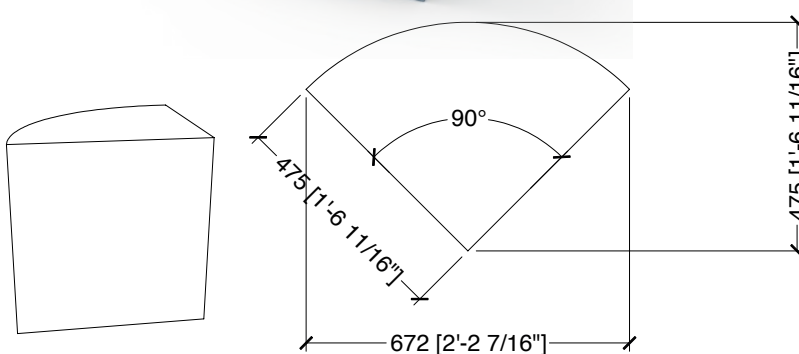

0 = product price in calculation - contact our office for pricing

SKEW
DESIGN KAZUKO OKAMOTO
2014



0 = product price in calculation - contact our office for pricing

SKEW

DESIGN KAZUKO OKAMOTO

2014



SKEW is a thrilling modular sofa designed by Kazuko Okamoto, a Japanese designer with her roots in Japan. Skew is a design idea that gives you the possibility to combine, turn, create unexpected twists to your project.

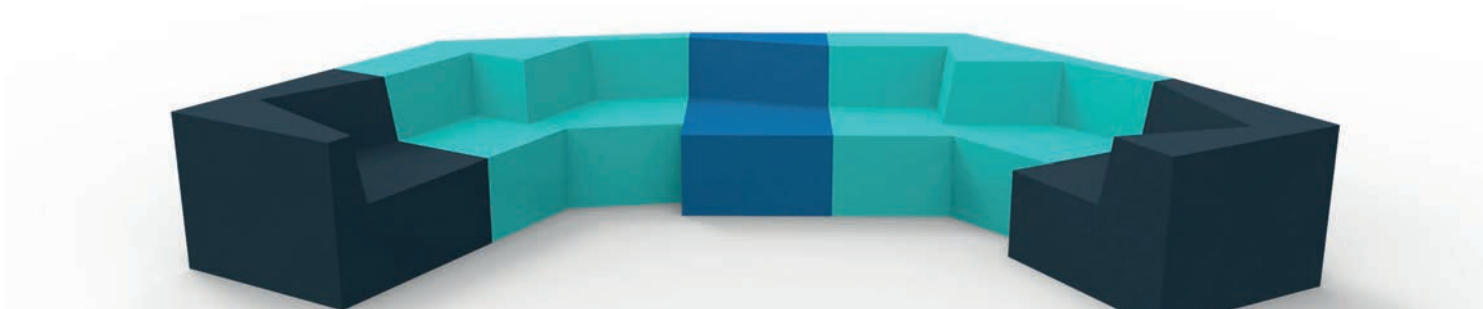

SKEW CHAIR CORNER

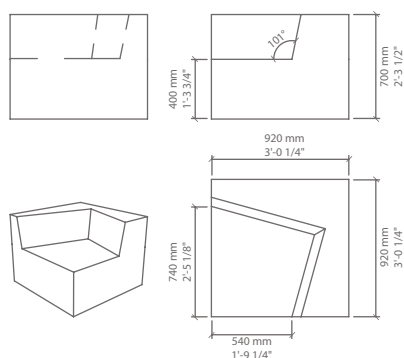

- Skew - chair corner - QM Foam skin
- Skew - chair corner - QM Plus foamskin double

SKEW CHAIR STRAIGHT

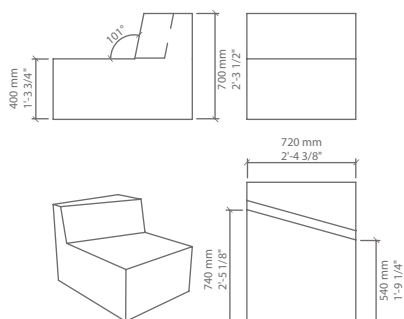

- Skew - chair straight - QM Foam skin
- Skew - chair straight - foamskin double

SKEW SOFA

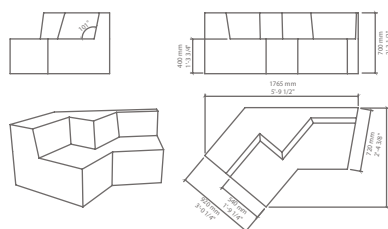

- Skew - sofa - QM Foam skin
- Skew - sofa - QM Plus foamskin double

0 = product price in calculation - contact our office for pricing

SLING

DESIGN Patrick Rampelotto

2021



0 = product price in calculation - contact our office for pricing

SLING

DESIGN Patrick Rampelotto

2021



> SLING

> Design by Patrick Rampelotto, 2021

> The SLING collection offers a bistro table in powder coated steel for use outdoor. A solide metal frame with some clever solutions to range chairs and tables when not in use. Perfectly made for your bistro terrace. Optional seat and back cushions can be applied.

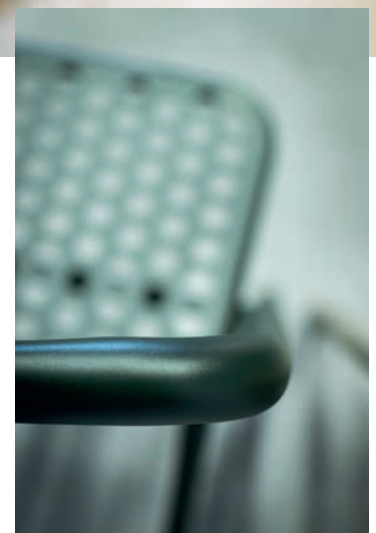
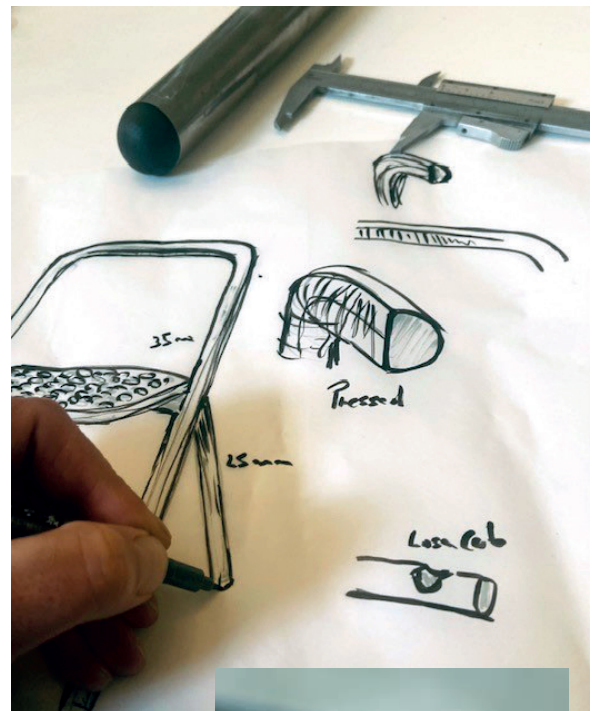

0 = product price in calculation - contact our office for pricing

SLING

DESIGN Patrick Rampelotto

2021



SLING CHAIR



0 = product price in calculation - contact our office for pricing

SLING

DESIGN Patrick Rampelotto

2021



SLING TABLE



0 = product price in calculation - contact our office for pricing

SLING

DESIGN Patrick Rampelotto

2021



SLING stackable bistro chair and folding table

the SLING bistro chair has been designed so it can easily be stacked

the SLING bistro table is designed with a folding top so it can be ranged in a limited space



0 = product price in calculation - contact our office for pricing

SLING

DESIGN Patrick Rampelotto

2021



0 = product price in calculation - contact our office for pricing

SQUARES

DESIGN SDC_lab

2016



SQUARES IS THE NEW SIZABLE SQUARE BLOCK.

Sizable in width, depth and height.

We offer some standard sizes but these blocks can easily be customized in all directions.

We offer some standard sizes for your convenience; keeping a standard seating height from 47,5cm the standard steps are 47,5 - 95 - 142,5

Square 01 starts from w47,5 x D 47,5 x h 47,5

Square 02 is then w95 x d95 x h 47,5

Square 03 is w142,5 x d142,5 x h47,5cm

Of course you can add your specific size to the blocks, keeping the base shape rectangular and seating height at 47,5cm

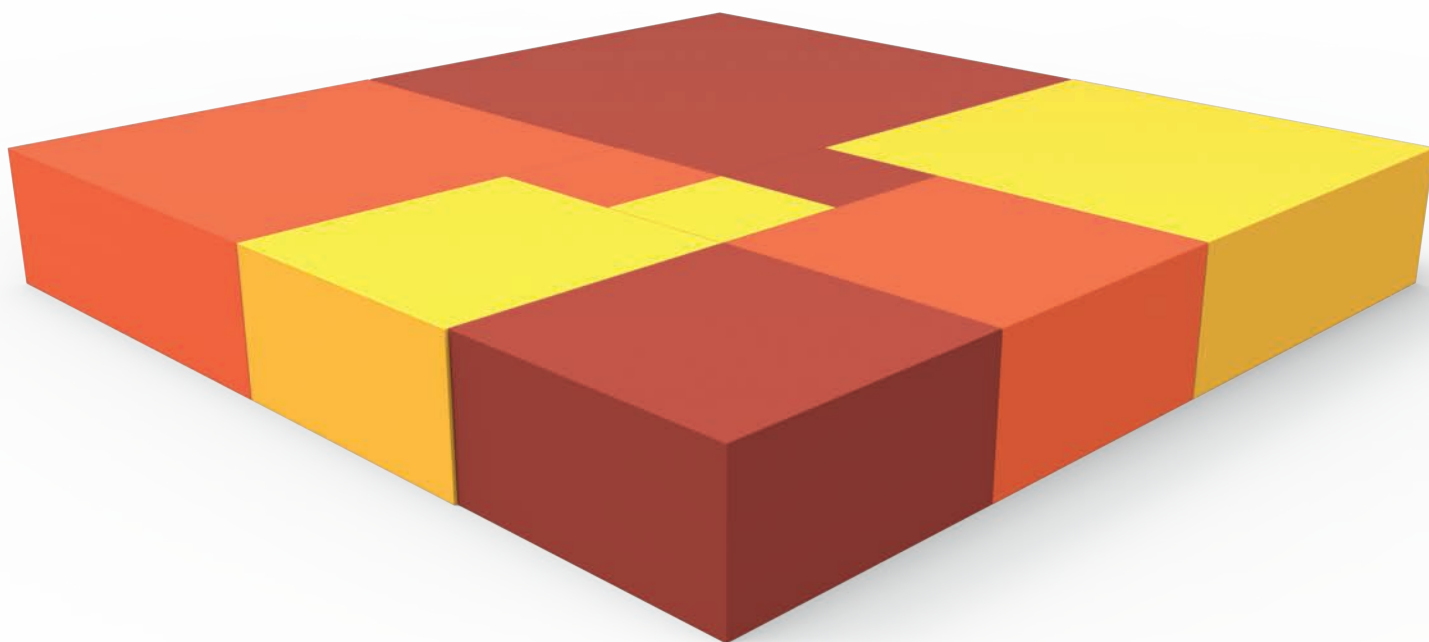
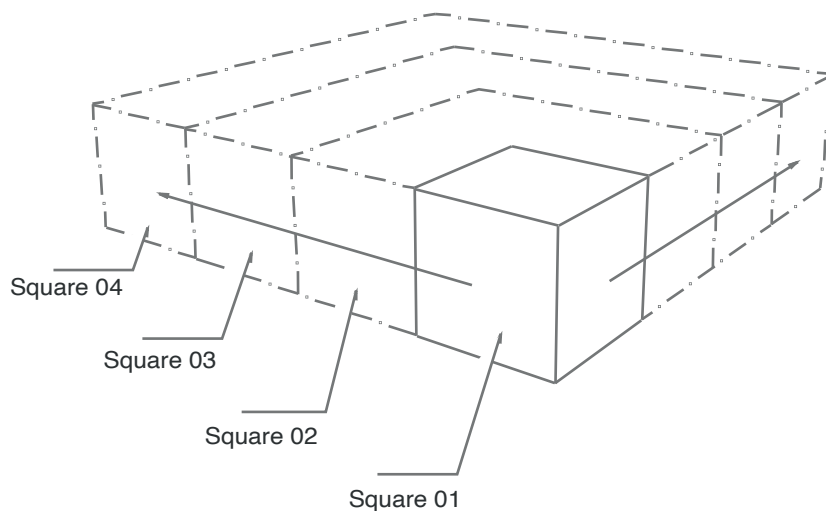

0 = product price in calculation - contact our office for pricing

SQUARES

DESIGN SDC_lab

2016



SQUARES 01

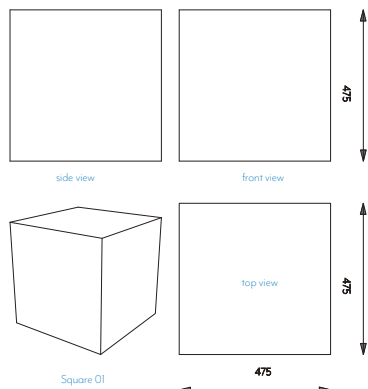

- Squares - Square 01 - QM Foam skin
- Squares - Square 01 - QM Plus foamskin double
- Squares - Square 01 - QM Tex foamskin Tex
- Squares - Square 01 - fabric CAT 1
- Squares - Square 01 - fabric CAT 2
- Squares - Square 01 - fabric CAT 0/COM

SQUARES 02

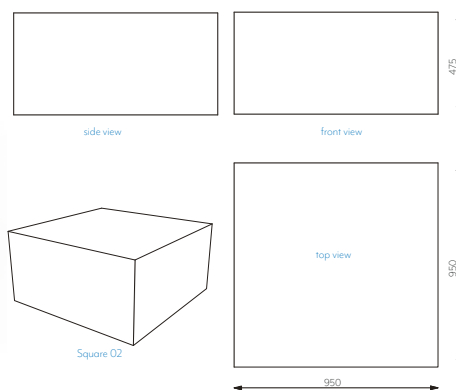
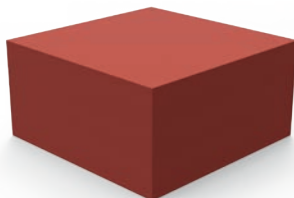

- Squares - Square 02 - QM Foam skin
- Squares - Square 02 - QM Plus foamskin double
- Squares - Square 02 - QM Tex foamskin Tex
- Squares - Square 02 - fabric CAT 1
- Squares - Square 02 - fabric CAT 2
- Squares - Square 02 - fabric CAT 0/COM

SQUARES 03

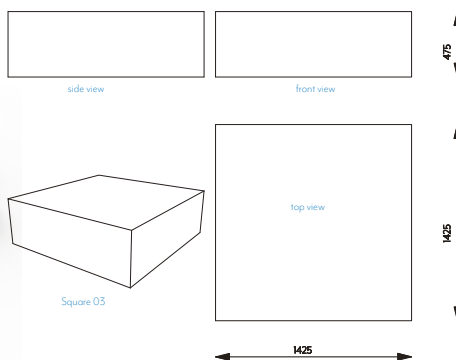
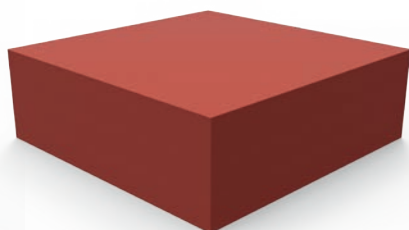

- Squares - Square 03 - QM Foam skin
- Squares - Square 03 - QM Plus foamskin double
- Squares - Square 03 - QM Tex foamskin Tex
- Squares - Square 03 - fabric CAT 1
- Squares - Square 03 - fabric CAT 2
- Squares - Square 03 - fabric CAT 0/COM

SQUARES 04

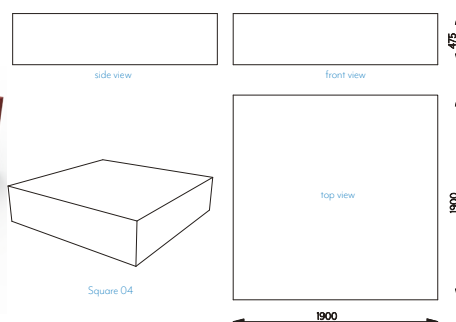
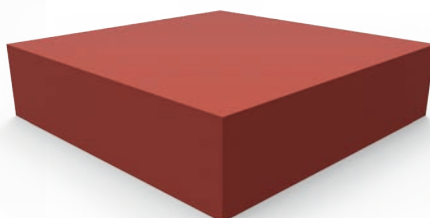

- Squares - Square 04 - QM Foam skin
- Squares - Square 04 - QM Plus foamskin double
- Squares - Square 04 - QM Tex foamskin Tex
- Squares - Square 04 - fabric CAT 1
- Squares - Square 04 - fabric CAT 2
- Squares - Square 04 - fabric CAT 0/COM

0 = product price in calculation - contact our office for pricing

STRAIGHTS

DESIGN SDC_lab

2016



STRAIGHTS IS THE NEW SIZABLE RECTANGULAR BLOCK.

Sizable in width, depth and height.

We offer some standard sizes but these blocks can easily be customized in all directions.

We offer some standard sizes for your convenience; keeping a standard seating height from 47,5cm and depth 47,5cm the standard steps are 95 - 142,5 - 190cm

Straight 01 starts from w95 x D 47,5 x h 47,5

Straight 02 is then w142,5 x d47,5 x h 47,5

Straight 03 is w190 x d47,5 x h47,5cm

Of course you can add your specific size to the blocks, keeping the base shape rectangular and seating height at 47,5cm

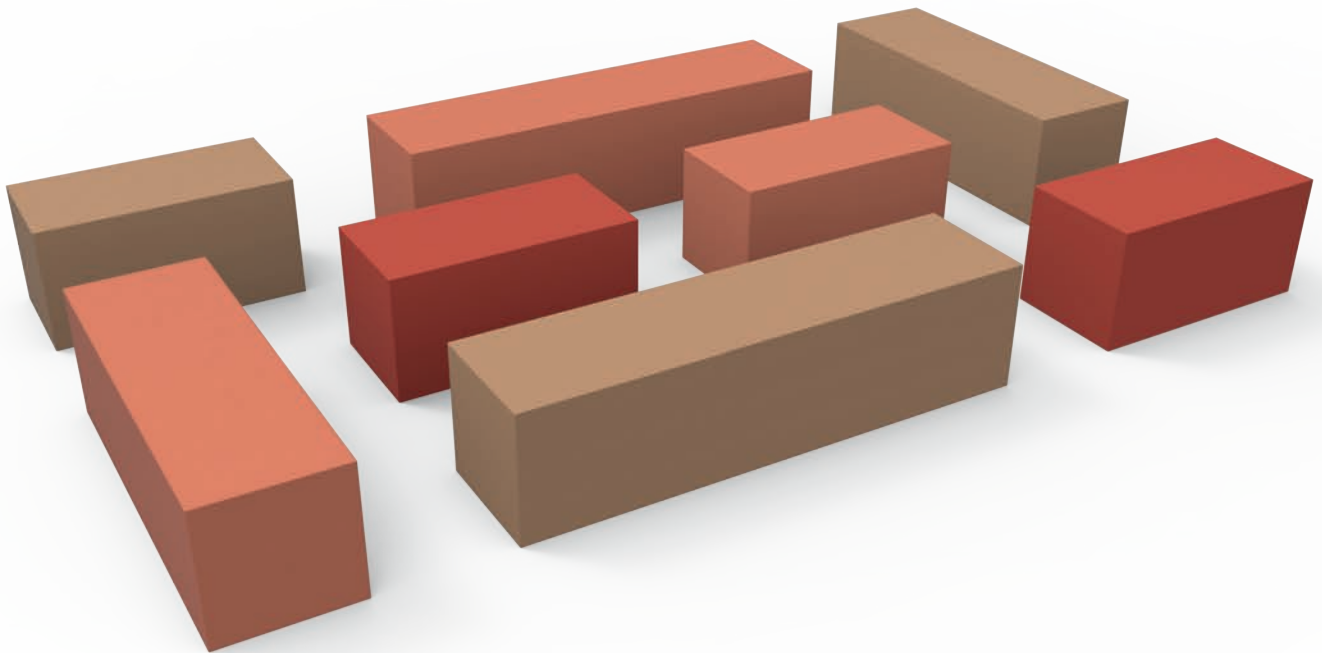
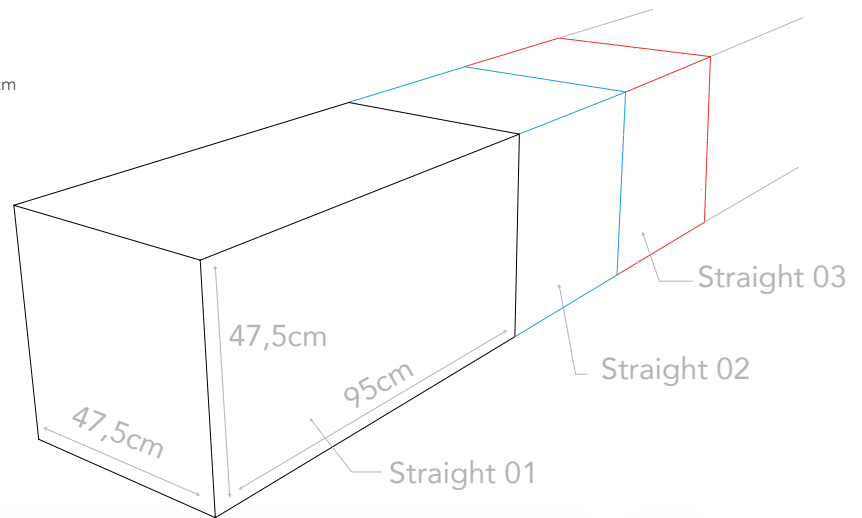

0 = product price in calculation - contact our office for pricing

STRAIGHTS

DESIGN SDC_lab

2016



STRAIGHTS 01

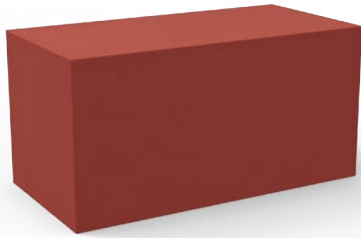

side view

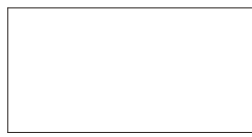

front view

475

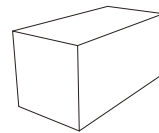

Straight 01



top view

475

950

- Straight - Straight 01 - QM Foam skin
- Straight - Straight 01 - QM Plus foamskin double
- Straight - Straight 01 - QM Tex foamskin Tex
- Straight - Straight 01 - fabric CAT 1
- Straight - Straight 01 - fabric CAT 2
- Straight - Straight 01 - fabric CAT 0/COM

STRAIGHTS 02

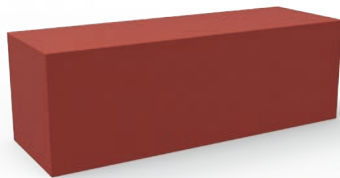

side view

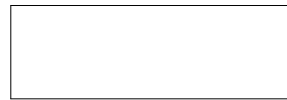

front view

475

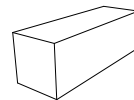

Straight 02



top view

475

1425

- Straight - Straight 02 - QM Foam skin
- Straight - Straight 02 - QM Plus foamskin double
- Straight - Straight 02 - QM Tex foamskin Tex
- Straight - Straight 02 - fabric CAT 1
- Straight - Straight 02 - fabric CAT 2
- Straight - Straight 02 - fabric CAT 0/COM

STRAIGHTS 03

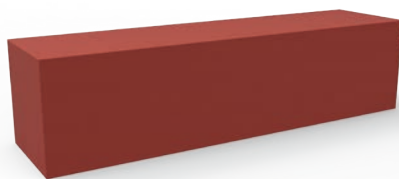

side view



front view

475

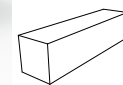

Straight 03



top view

475

1500

- Straight - Straight 03 - QM Foam skin
- Straight - Straight 03 - QM Plus foamskin double
- Straight - Straight 03 - QM Tex foamskin Tex
- Straight - Straight 03 - fabric CAT 1
- Straight - Straight 03 - fabric CAT 2
- Straight - Straight 03 - fabric CAT 0/COM

0 = product price in calculation - contact our office for pricing

STAIR SEAT

DESIGN SDC lab
2016

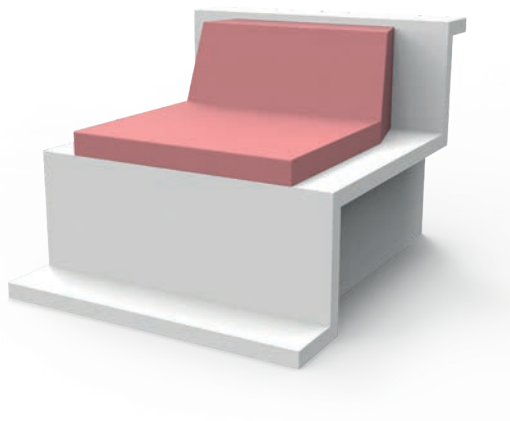
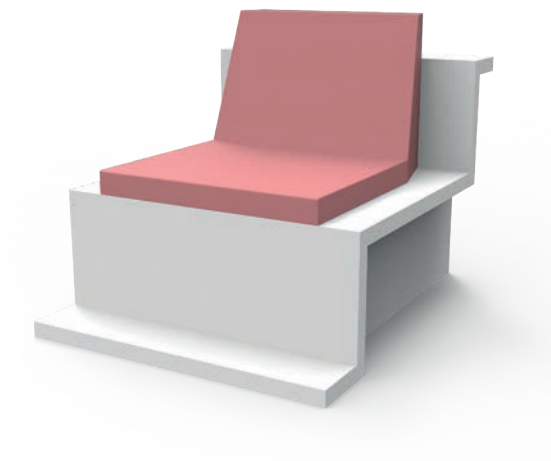

STAIR SEAT L cushion



Stair seat L

-
- Stair Seat - L cushion no back - QM Foam skin
-
- Stair Seat - L cushion no back - QM Plus foamskin double
-
- Stair Seat - L cushion no back - QM Tex foamskin Tex
-
- Stair Seat - L cushion no back - fabric CAT 1
-
- Stair Seat - L cushion no back - fabric CAT 2
-
- Stair Seat - L cushion no back - fabric CAT 0/COM
-

STAIR SEAT L cushion with high back

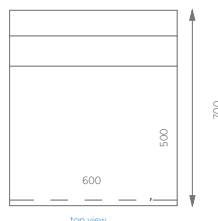
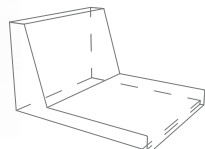
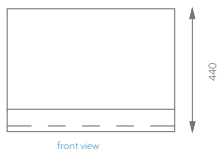
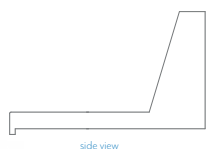

Stair seat L with backrest

-
- Stair Seat - L cushion with back - QM Foam skin
-
- Stair Seat - L cushion with back - QM Plus foamskin double
-
- Stair Seat - L cushion with back - QM Tex foamskin Tex
-
- Stair Seat - L cushion with back - fabric CAT 1
-
- Stair Seat - L cushion with back - fabric CAT 2
-
- Stair Seat - L cushion with back - fabric CAT 0/COM
-

0 = product price in calculation - contact our office for pricing

STAIR SEAT

DESIGN SDC lab
2016



STAIR SEAT HIGH BACK

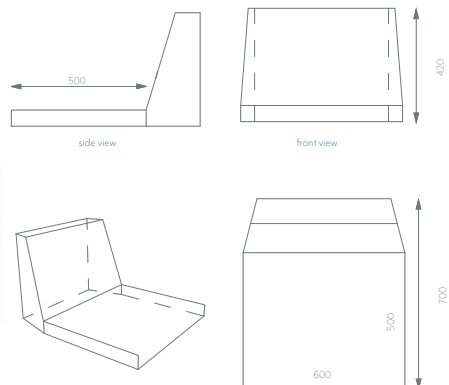

-
- Stair Seat - high back - QM Foam skin
-
- Stair Seat - high back - QM Plus foamskin double
-
- Stair Seat - high back - QM Tex foamskin Tex
-
- Stair Seat - high back - fabric CAT 1
-
- Stair Seat - high back - fabric CAT 2
-
- Stair Seat - high back - fabric CAT 0/COM
-



STAIR SEAT LOW BACK

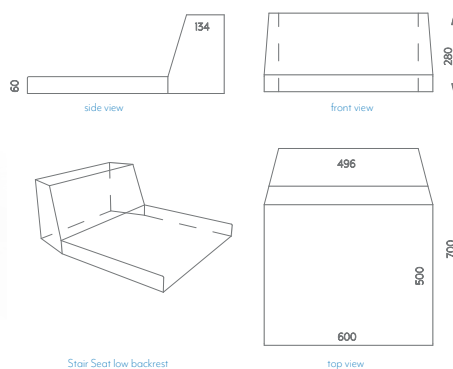

-
- Stair Seat - low back - QM Foam skin
-
- Stair Seat - low back - QM Plus foamskin double
-
- Stair Seat - low back - QM Tex foamskin Tex
-
- Stair Seat - low back - fabric CAT 1
-
- Stair Seat - low back - fabric CAT 2
-
- Stair Seat - low back - fabric CAT 0/COM
-

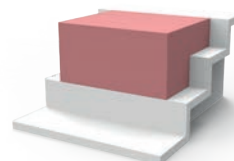

STAIR SEAT PLATFORM

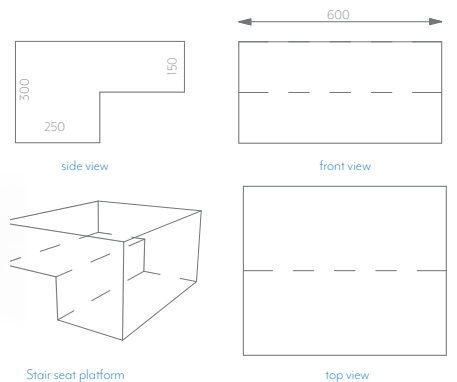

0 = product price in calculation - contact our office for pricing

UDA

DESIGN SDC_lab (intern Paul Gallaud)

2017



0 = product price in calculation - contact our office for pricing

UDA is a the new 'rocking' pouf.

Paul Gallaud was working with us as an intern; All of the sudden he came with the idea to make a new rocking pouf.

Available in 3 sizes and different finishings.

Give it to kids or use it in informal spaces to sit, to play or just as a seat around a meeting room table.



UDA small

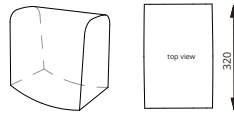
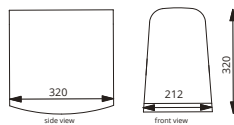

- Uda - small - QM Foam skin
- Uda - small - QM Plus foamskin double
- Uda - small - QM Tex foamskin Tex
- Uda - small - fabric CAT 1
- Uda - small - fabric CAT 2
- Uda - small - fabric CAT 0/COM

UDA medium

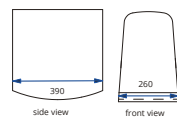

- Uda - middle - QM Foam skin
- Uda - middle - QM Plus foamskin double
- Uda - middle - QM Tex foamskin Tex
- Uda - middle - fabric CAT 1
- Uda - middle - fabric CAT 2
- Uda - middle - fabric CAT 0/COM

UDA large

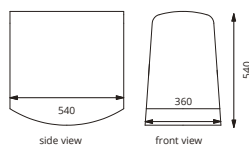

- Uda - large - QM Foam skin
- Uda - large - QM Plus foamskin double
- Uda - large - QM Tex foamskin Tex
- Uda - large - fabric CAT 1
- Uda - large - fabric CAT 2
- Uda - large - fabric CAT 0/COM

0 = product price in calculation - contact our office for pricing



PLATFORM
FOR
FURNITURE

MAKE YOUR OWN FURNITURE SPACE DRIVEN SOLUTIONS

SDC's in house design team can help you with 'customizing' your ideas.

The professional approach guides you towards the ideal solution, taking into account many aspects such as finishing, density, ergonomics, power integrations,...

Contact us at info@sdclab.be

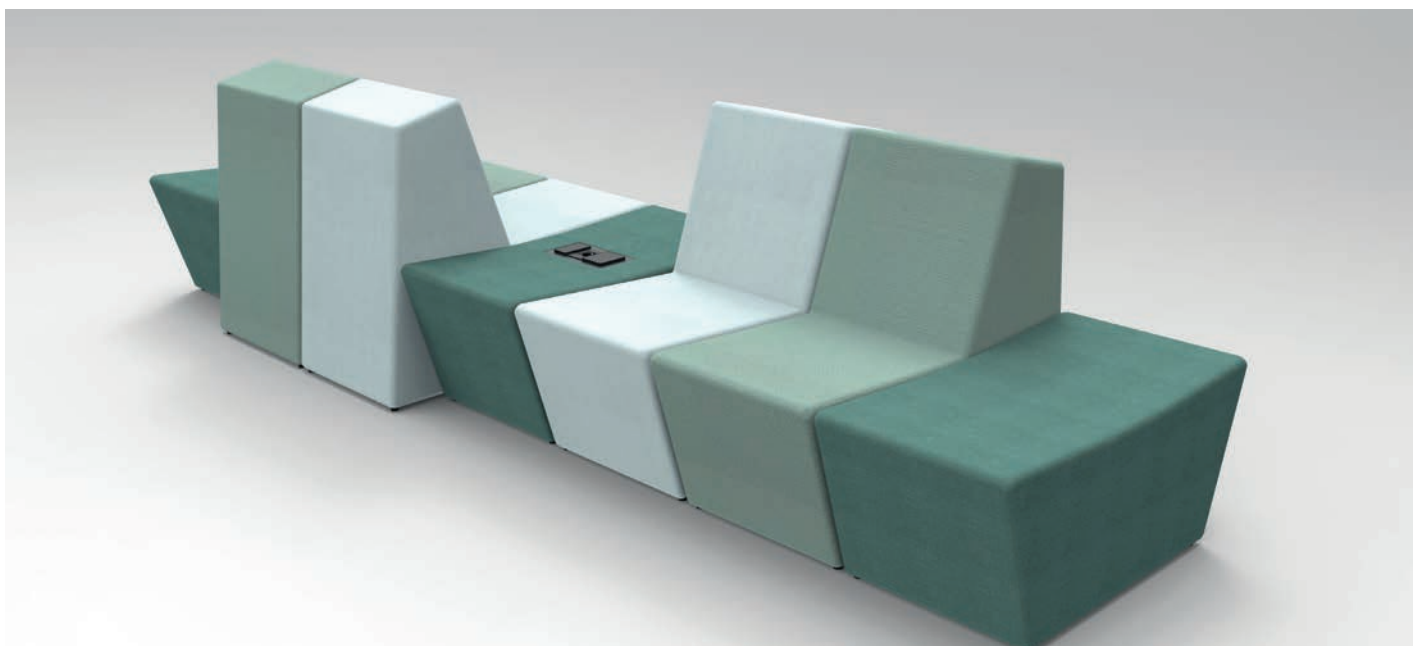
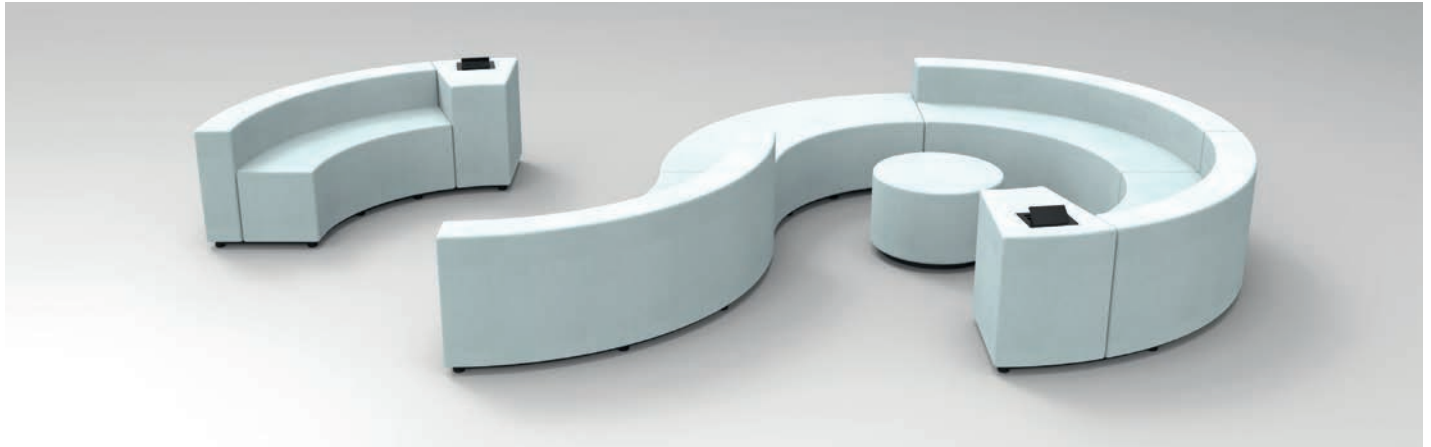

IN ADDITION TO PRODUCING FURNITURE AT OUR IN-HOUSE FACTORY, WE WORK WITH ARCHITECTS AND DESIGNERS TO REALISE THEIR IDEAS/ DESIGNS.

OUR PRODUCTION TECHNIQUES ALLOW US TO MAKE A LOT OF SHAPES, FROM RECTANGULAR TO ORGANIC.

BUT STILL THERE ARE SOME GUIDELINES.

GLUE LINES

Straight units shorter than 210cm can be made out of 1 piece. We can also produce units which are longer but then, a glue line might be visible.

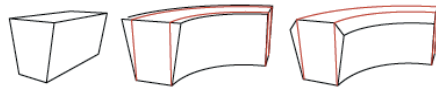

INTEGRATIONS

in this area of technical wildlife, we need to create furniture with clever integrations. We can integrate tablets, screens, powerunits, etc. into our furniture products.

UPGRADES

For hygienic en maintenance purposes in public areas, we often propose to add a plinth. A plinth can be made out of foam or wood, depending on the clients demands. A wooden plinth can be provided of a black laminated or a stainless steel finish.

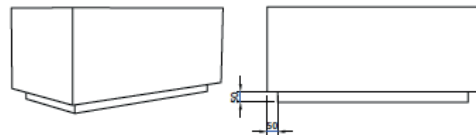

DIMENSIONS

For cushions or wall panels, a minimum foam thickness of 5cm is required.

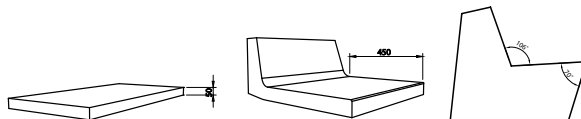

FIXATION

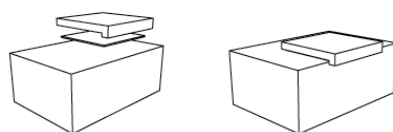

For cushions which are meant to be mounted on a wooden base or a wall, we always use a wooden plate underneath the foam for fixation with screws. That plate is smaller than the foam and will be coated in the same color as the foam.



PLATFORM
FOR
FURNITURE

UPGRADES

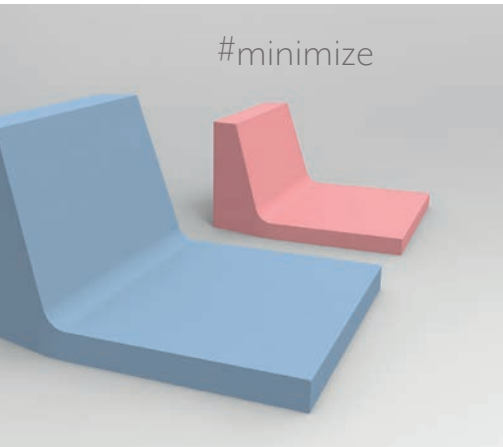

#minimize
#screenprinting
#tablet integration
#power integration

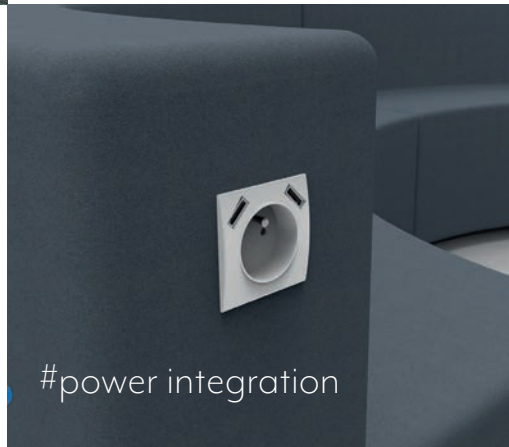

#outdoor





PLATFORM
FOR
FURNITURE

#SCREENPRINTING

ADD GRAPHICS

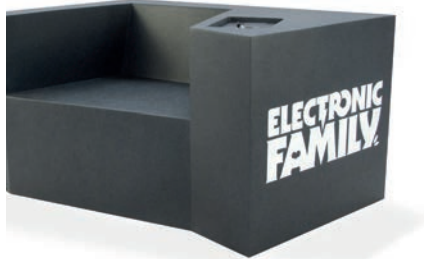

As customization is part of our DNA, we also found a solution to add company logos or graphical effects to our furniture.

Our customized items can be pimped up with your logo.

A technique with screenprinting offers new solutions for branding requirements

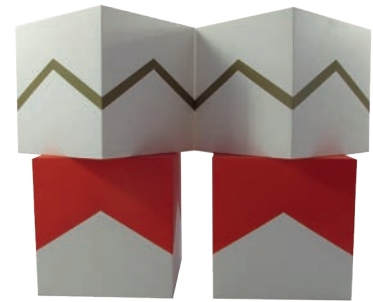



PLATFORM
FOR
FURNITURE

#POWER INTEGRATION

DEVICE EMBEDDING YOU ASK, WE CREATE

To answer to the need of connectivity in our social environments, we have developed custom made bases and connections for our furniture that allow you to securely plug in electronic devices like tablets, phones, earplugs among others to allow the user of this furniture to expand its experience to another level. The base is custom made and can be adapted to your device or furniture of choice.

Technical details:

Option 1:

Built-in plate, made to custom size (up to 50cm x 50cm). Cables can pass through the furniture.

Option 2:

Customized integration of anti-theft systems for e-readers and tablets of various brands. Completely with power integration and cables.

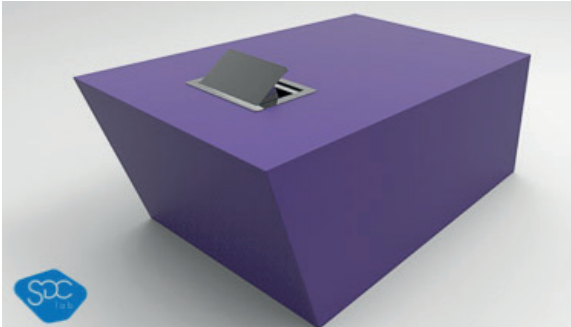

Contact us with your ideas!



#TABLET INTEGRATION





PLATFORM
FOR
FURNITURE

#MINIMIZE

SCALE
SHRINK
MINIMIZE

You can call it what you want, but the result is the same!

We can scale most of our furniture items down to the size that kids can also play with our furniture!

We're not only giving you the opportunity to play with colors, but you can also make the furniture onto kids' sizes

Contact us with your ideas!





PLATFORM
FOR
FURNITURE

#FEET #SOCCLE #CONNECTOR

Connecting the pieces

For some occasions special feet are required in a project. Or even more, we can offer you a customized soccle which gives an extra protection against abuse or damage.

These feet can also have a connecting purpose. With a simple system, we created an easy way to connect the different pieces.

Contact us!

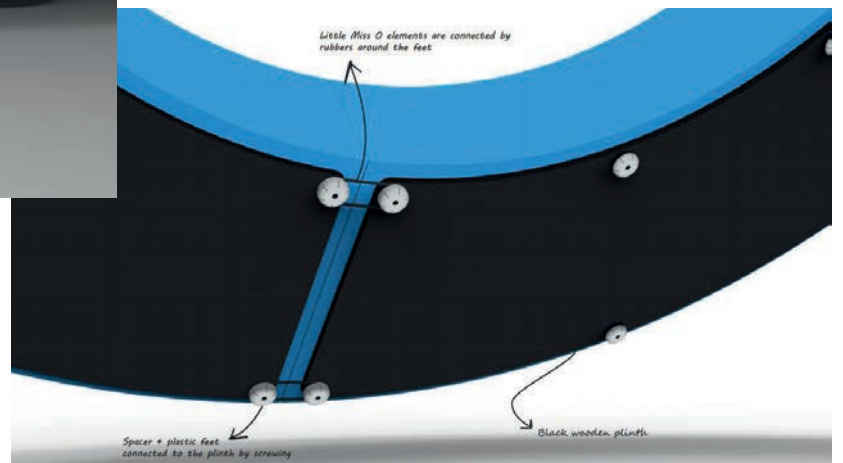
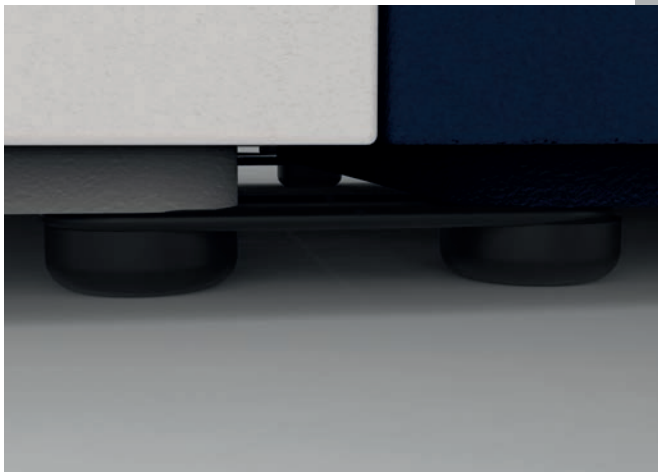



QM Coating products

Our QM coating products are water repellent. So this means that they don't care about a little bit of water.

But they can't be use for permanent outdoor use in all climatical conditions.

Contact us for appropriate advice!



Following the sun

We know that you sometimes would like to take your favorite pieces of furniture outside.

But not all items are standard suitable for outdoor use. But we can easily modify them to be suitable for outdoor use.

Contact us!

Permanent outdoor use!

Our foamcoating is not recommended for permanent outdoor use.

We can in most cases change the type of foam and fabric to be suitable for permanent outdoor use!

Using a special foam for outdoor use and some special fabrics combined with a special finishing technique gives you the best result.

Contact us!

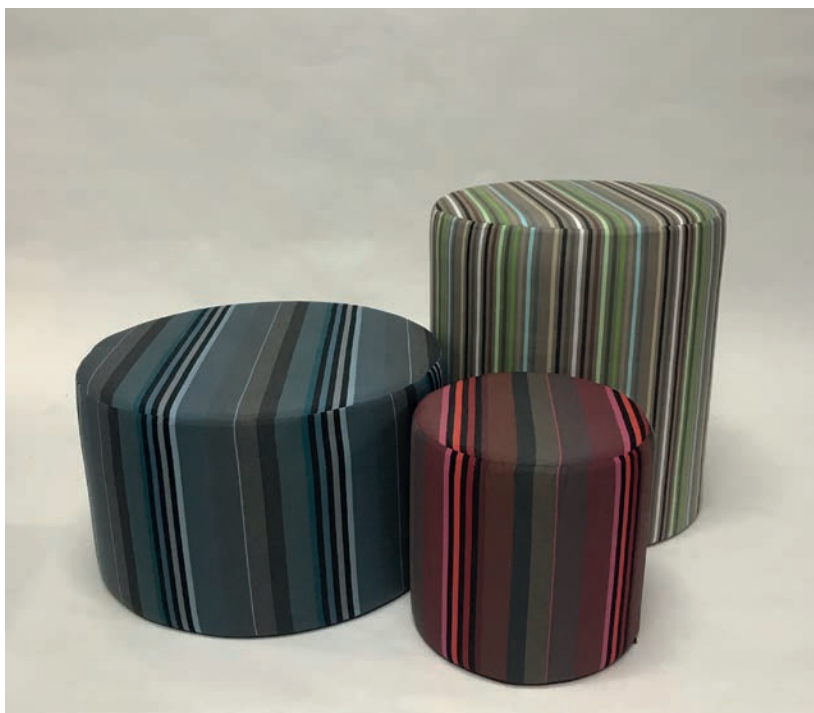



Article 1 Scope.

§ 1. These general terms and conditions apply to every offer made by, every agreement concluded with and every delivery made by SDC bvba, with company number 0545.930.648 and with registered office at 8560 WEVELGEM, 13 (hereinafter: "SDC") and are an integral part of the contractual relationship between SDC and the customer. They supplement the special conditions agreed by the parties. Insofar as the special conditions that the parties agreed to deviate from these general terms and conditions, the special conditions that the parties agreed to take precedence over these general terms and conditions.

§ 2. By the mere fact of accepting an offer made by, entering into an agreement with and / or accepting a delivery made by SDC, the customer acknowledges to have read and accepted these general terms and conditions.

§ 3. The customer acknowledges that the application of his own general terms and conditions is expressly excluded.

Article 2 Conclusion of the agreement.

§ 1. Unless SDC has explicitly stated otherwise, all its offers are non-binding and non-binding. SDC is only bound when it has confirmed the customer's order. SDC's quotations are in any case subject to sufficient stock.

§ 2. Only persons who have external representation authority under the SDC articles of association can bind SDC. The employees of SDC and the intermediaries to whom it would appeal cannot, as a rule, bind SDC unless they provide a written proxy.

§ 3. The customer can no longer cancel his order that SDC has accepted unless SDC agrees to this in writing. In case SDC agrees to such cancellation, the customer will in any case, unless otherwise agreed in writing, owe a cancellation fee of 30% of the amount of the canceled order.

Article 3 Prices.

§ 1. Unless SDC has indicated otherwise in writing, the prices quoted by SDC are expressed in euros and exclude VAT, packaging costs and shipping costs.

§ 2. For orders with a value less than EUR 900 excl. VAT, an extra administration fee will be charged on top of the agreed price.

§ 3. SDC has the right to determine which packaging and which shipping method are most suitable. Packaging will not be taken back.

§ 4. Prices for coated products are so conceived that everything is done in one standard color.

As soon as you want an extra color within an order, you must add a color change. A small surcharge is charged for this, regardless of the numbers per color. The prices of this color change are stated on the offer.

In the case of custom colors, a supplement will also be requested.

§ 5. Discounts and reductions

Unless expressly stated in the order confirmation from SDC, the buyer is not entitled to any direct or indirect discount, reduction, commission or reduction of any kind. Any discount promised by SDC for the prepayment of an invoice will only be granted if the full amount stated on the invoice has been received by SDC on or before the invoice's due date.

Article 4 Delivery.

§ 1. SDC always has the right to split the customer's order into partial deliveries.

§ 2. The delivery terms for SDC are always approximate (indicative) unless it has been expressly agreed in writing that the delivery term can be strictly observed by means of the statement "mandatory delivery term" or a similar statement that unambiguously indicates the punctuality of the delivery term. SDC will use its best endeavors to comply with the approximate delivery time specified by it. The customer acknowledges that he is aware that deviations from the delivery period can always occur, among other due to delays at producers, suppliers and execution agents on which SDC depends and / or its possibilities of preparing and sending the goods. In the event of a delay in implementation, the customer will in no case be able to demand the termination of the agreement and the customer will in no way be able to claim any compensation of any kind from SDC. If SDC, in case of a mandatory delivery period, has not executed on time, the customer must first notify SDC by registered letter and give a last grace period of at least 15 days before he can invoke any sanction against SDC. The delivery terms for SDC will in any case be automatically extended by the duration of the period that the customer itself is in default to perform any obligation, without SDC having to first notify the customer and / or by the duration of the period. in which SDC was confronted with force majeure.

§ 3. Delivery takes place at the address indicated by the customer upon confirmation of the order.

All deliveries are performed by international transport as standard.

When submitting the order, we ask to provide a responsible person on delivery who can receive the goods.

SDC cannot be held responsible for the delivery schedules of the carrier and any delays and cannot accept compensation on this matter. All orders are delivered to the first gate on the ground floor of the customer's building. Exceptions to this rule must be confirmed by written agreement.

It is recommended to provide delivery to a warehouse that can receive the goods in good conditions.

Additional costs may apply to all deliveries with a truck with tail lift.

§ 4. The goods will be checked by the customer immediately upon delivery for their conformity and for any visible defects. If the customer sees visible defects on delivery, he must explicitly state these on the CMR. If the customer does not do this, SDC has the right to decline full responsibility for all damage.

§ 5. Counting from the moment that the customer is in default of collecting / receiving the goods, further storage of goods takes place at the expense and risk of the customer and against payment of a fee per day depending on the place in which these goods are stored. take over the SDC warehouses.

§ 6. In any case, the customer is responsible for loading, stacking and securing the goods on his vehicle.

Artikel 5 Transfer of ownership - retention.

SDC retains exclusive ownership of all goods it supplies until all amounts due under the delivery, including any lump sum compensation, default interest and costs due in the event of late payment, have been paid in full.

The customer can therefore in no way dispose of the goods that are still owned by SDC in application of the previous paragraph. More specifically, he may not transfer them to third parties or object them with any certainty. Nor may he process, process, consume, incorporate them into other goods or mix them with other goods.

Artikel 6 Risk transfer.

The risk with regard to the goods is transferred to the customer when the goods are ready for collection or shipment to the customer in SDC's warehouses, regardless of whether they have already become the property of the customer.

The shipment of goods is always at the risk of the customer, regardless of who is responsible for the shipping costs.

Artikel 7 Billing and Payment.

§ 1. Unless otherwise agreed in writing or otherwise stated on SDC's invoices, SDC's invoices are payable in cash.

§ 2. The amount of SDC's invoices must be paid net without discount. Eventual (bank) costs are charged to the customer.

§ 3. If an invoice is incorrect, it must be protested with a registered letter within 15 days of the invoice date. Invoices that have not been protested within the aforementioned period and in the aforementioned manner will automatically be considered accepted.

§ 4. The place of payment of the customer's debts to SDC is at the registered office of SDC.

§ 5. The customer cannot refuse to pay for the goods already delivered by SDC because the totality of SDC's commitments has not (yet) been executed. Nor can the customer refuse to pay for delivered goods if he considers that the goods are non-compliant and / or defective and SDC has not acknowledged this.

§ 6. SDC has the right to first allocate payments to any costs owed, the conventional lump sum compensation and all overdue default interest before allocating it to the outstanding principal (s).

§ 7. If reasonable doubt can arise about the solvency of the customer - such as if the customer requests deferment of payment from a creditor, the customer does not pay one or more invoices from a creditor (in time), an attachment has been made at the expense of the customer, for the customer insolvency proceedings have been filed or opened (judicial reorganization, bankruptcy, collective debt settlement or similar proceedings), the customer is involved in a restructuring (merger, division, contribution from a universality or industry), the customer is dissolved and liquidated - SDC has the right to demand an advance or full advance payment for the commitments still to be performed, or to demand the provision of (additional) securities.

§ 8. SDC always has the right (also in the case of overlapping of creditors) to offset all amounts that SDC would owe the customer for whatever reason with the amounts owed by the customer to SDC, regardless of whether or not these amounts are already due and payable.

§ 9. For new customers (customers who order a 1st time) a 100% advance payment is requested from the invoice. The order will only be prepared after receipt of this payment. So only from the moment of payment also the delivery period starts to run. Afterwards, the customer can receive a payment term of 30 days after the invoice date, if they have an approved credit.

§ 10. The following conditions always apply to custom orders:

50% with order confirmation (only after receipt of payment, the production period starts to run)

40% before shipment of the goods (if the customer has an approved credit)

10% in 30 days (if the customer has an approved credit)

If the customer does not have an approved credit, he must pay the remaining 50% before shipping the goods.

Artikel 8 Breach of contract

§ 1. In the absence of payment within the due date of one or more invoices, SDC has by operation of law and without notice of default

- right to the payment of default interest at a conventional interest rate equal to the interest rate referred to in Article 5 of the Law of 2 August 2002 on combating late payment in commercial transactions from the invoice date, as well as

- (b) right to payment of a flat-rate compensation of 10% of the amount not paid (on time), with a minimum of EUR 75, - and this without prejudice to SDC's right to compensation of the legal costs (including court fees) in the event of a judicial recovery procedure. must be fed.

§ 2. In the absence of payment on the due date of one or more invoices (drawn up in the context of the same or a different agreement), all outstanding but not yet due invoices that SDC issued to the customer will be due and payable by operation of law and without notice. due in § 1.

§ 3. In the absence of payment on the due date of one or more invoices (drawn up under the same or a different agreement), SDC has the right to suspend commitments that still have to be performed until it has received full payment.

§ 4. SDC has the right to dissolve the agreement without judicial intervention, with immediate effect, in whole or in part (i.e. for the part still to be executed) without being liable for any compensation, provided that it sends a registered letter informing this decision.

- in case of inability to issue one or more checks without cover due to protest of one or more bills due to seizure of charges, dissolution and liquidation of a collective debt settlement or bankruptcy of the customer

- (b) in case the customer fails to fulfill one or more of his obligations towards SDC, including the timely payment of the invoices drawn up by SDC or the requested advances or advance payments and the provision of (additional) securities, and this was not met within 15 days following a notice of default by SDC

- (c) in case the customer indicates that he will not fulfill his obligations.

In the event of dissolution, SDC is entitled to additional compensation at a flat rate of 50% of the amount SDC would have been entitled to if the agreement had been properly executed. In the



event of dissolution, the goods already delivered must be returned to SDC at the customer's expense, plus compensation for the depreciation that it may have undergone for whatever reason. In the event of partial termination, the part of the agreement executed by SDC must be paid in full by the customer and the additional compensation will be calculated on the part of the agreement that has not yet been executed.

Artikel 9 Liability.

§ 1. SDC will only be liable for damage caused by the non-execution, the incomplete execution, the late execution or the improper execution of its obligations in the event of its intentional or gross error. SDC is not responsible for any errors - including intentional and gross errors - committed by its employees and executive agents. SDC's liability is limited to compensation of foreseeable, direct and personal damage to the customer, to the exclusion of all indirect or intangible damage, including, without limitation, loss of profit, loss of customers or contracts and additional costs.

Any compensation payable by SDC will be limited to a maximum of the amount that SDC has invoiced to the customer or that it may have contractually invoiced for the goods that gave rise to the customer's damage. The customer expressly and unconditionally waives any further claims for damages of any kind at SDC's expense.

§ 2. If the goods are found to be non-compliant or if visible defects are found, the customer must immediately inform SDC and confirm his detailed complaints / findings in a registered letter to SDC within 48 hours after delivery, failing which the customer will not take any will be entitled to more repair, replacement or compensation. A legal claim must be instituted, under penalty of forfeiture, within 2 months after the establishment of the non-conformity / defect. The limitations of liability stated in §1 further apply.

§ 3. If hidden defects are discovered, the customer must immediately inform SDC and confirm his detailed complaints / findings within 48 hours after the defects have been identified by registered letter to SDC, failing which the customer will not be entitled to any repair, make more replacement or compensation. A legal claim must be instituted, under penalty of forfeiture, within 2 months after the establishment of the non-conformity / defect. The limitations of liability stated in §1 further apply.

§ 4. Unless the customer has informed SDC in writing, SDC is assumed to have no knowledge of the concrete use that the customer will make of its goods. The customer must check whether the technical properties of the goods are adequate for the use he wants to make of them.

§ 5. SDC is not liable for the result of operations that the customer performs or has performed on the goods.

§ 6. SDC is not liable for damage that has arisen after the goods have been changed by the customer or by a third party (through processing, processing, incorporation, mixing or otherwise).

§ 7. The information contained on the SDC website (www.sdclab.be) is for information only. No rights can be derived from this information in any way, nor can this information give rise to any claims or (legal) claims.

§ 8. If SDC is liable (especially for non-conforming and / or defective goods), the customer must always give SDC the opportunity and allow a reasonable time to repair or replace the (non-conforming or defective) goods, before he can rely on any other remedy.

§ 9. The limitations of liability provided for in this article will always be interpreted in the sense that they have been legally interpreted. In the event that a limitation of liability provided in this article for certain hypotheses is not legally valid, such hypothesis will be deemed not to be intended / unwritten.

Artikel 10 Privacy

SDC makes every effort to comply with the obligations under the General Data Protection Regulation (GDPR). Any personal data is collected and kept by SDC for the following purposes:

- to be able to follow up on your order and / or questions about our goods
- to optimize cooperation with the customer;
- to be able to inform the customer about SDC goods and / or changes in the range
- to comply with any legal obligations incumbent on SDC;
- for handling financial transactions under the agreement with the customer;
- for sending our newsletters and (eventual) advertising messages in our sector.

For more information about the processing of personal data, SDC would like to refer to its privacy policy as shown on its website www.sdclab.be

The customer can request to change, delete or transfer his data at any time by email to info@sdclab.be

If the customer does not agree with the way in which his data is processed, he can contact the Commission for the protection of privacy (Drukpersstraat 35, 1000 Brussels, +32 (0) 2 274 48 00, commission@privacycommission.be).

Artikel 11 Force of the majority

In the event that SDC is confronted with a force majeure situation, the performance of its obligations will be automatically suspended as long as that force majeure situation continues. If that situation of force majeure lasts longer than 2 months, SDC can declare the agreement dissolved, in which case it will be released from all its obligations. The customer is not entitled to compensation or reimbursement of amounts already paid if SDC is faced with a situation of force majeure.

Force majeure for SDC includes all circumstances that are not due to an error on the part of SDC and that make it impossible to implement SDC's commitments, seriously complicates them, seriously delays them or makes them at least 5% more expensive, including but not limited to fire, machine breakdown, accidents, strikes or lockouts, exceptional traffic disruptions, exceptional weather such as storm, snow and floods, import or export restrictions, tax increases, taxes, fees, charges, duties and customs or other government measures, exchange rate fluctuation, inflation, epidemic, riot or war, errors, delays, price increases or force majeure in suppliers of goods or services. The unacceptable and unavoidable nature of the aforementioned circumstances is always deemed to have been acquired.

Artikel 12 Extensive right of retention.

SDC is allowed to withhold all of the customer's property that it owns / detains (on its premises, in its warehouses and workshops, in its vehicles ...) until the customer owes all its debts to SDC (principal, interest, compensation, costs, ...) for whatever reason (including other agreements) has paid.

Article 13 Warranty.

2-YEAR LIMITED WARRANTY

Unless otherwise agreed at the time of the order, we offer a warranty for our products for 2 years after their shipment. This warranty applies to defects in design and material, provided that the product is used in the correct conditions and that it is used as intended. For example: - chairs are not expected to be used for more than 40 hours per week - all products using QM FOAM are only intended for sitting and / or sleeping. The guarantee therefore does not apply to jumping, standing or walking on the furniture. The usual wear and tear of the products is also expressly excluded from the warranty. After a while, the products for which QM FOAM was used will show an "oxidation layer" and a certain "texture". This was deliberately chosen as part of the design and can in no way be considered damage. During the life of the product, SDC offers the buyer after-sales services. Products made of veneer and laminate are not covered by the warranty, but SDC will pass on to the purchaser any warranty that SDC itself has received from manufacturers of veneer and laminate products.

Damage caused by water, ultraviolet light, sea or extreme temperature changes is expressly excluded from the warranty. SDC makes no other warranty for products or their suitability for any other purpose, as well as no other express or implied warranty. Products that do not meet the description, are defective in any area or that are defective in terms of execution or material will be replaced, repaired or, if SDC so decides, credit will be given to the buyer at the value of the original purchase price, provided that SDC is notified of such defect within seven (7) days of delivery and that the purchaser returns the product according to SDC's instructions. The aforementioned represents the sole remedy for the purchaser and SDC's sole obligation with regard to delivered products. The buyer agrees to waive any and all rights or claims against SDC in accordance with law and fairness. SDC is not liable for direct, indirect, incidental, special or resulting damage under any circumstances, including damage or loss resulting from inability to use the products, increased operating costs or production loss, or any other form of damage results from reasons similar to the above or not (this list is not exhaustive). This warranty gives you specific legal protection, which may vary from state to state or country to country. Some states do not allow limitations on how long an implied warranty lasts, so the above limitations may not apply to you.

Artikel 14 Designs

All designs shown in our catalog and associated prices are and remain our property. All dimensions shown are only an indication. SDC's catalog and price list are not available to the general public and are only released commercially to encourage purchase.

Artikel 15 Material

SDC carefully selects only the finest, best quality material for its products. Although SDC makes every effort to ensure a consistent appearance of the products, all products sold are subject to commercially acceptable variations or inequalities in color, surface, texture or texture. These deviations are due to the nature of the materials and the techniques used. Since wood is a natural raw material, its color changes over time. This is due to the influence of sunlight, but is also due to the aging of the wood itself. Differences in color can therefore also differ from load to load. Since our tables and chairs come from different production loads, slight differences in color and texture are possible.

C.O.M./UPHOLSTERY

C.O.M.stuffs should be sent to SDC completely free of charge. The fabric requirements are indicated by SDC and always refer to uniform, solid colored fabrics, with a width of 140 cm. Unless expressly agreed in advance, SDC will refuse fabrics with a pattern. Stripes and lines are also considered patterns in the areas of cutting and knitting, and must therefore be announced in advance. For leather orders, we use a minimum order quantity per color. Several production loads of fabrics and leather may differ slightly in terms of hue. This means that SDC checks the substances against grayscale ((UNI EN 20105 A02 / A03) but cannot be held responsible for unavoidable persistent minor differences.

Artikel 16 Varia.

If it has been agreed that goods will be delivered on demand, all goods that have not yet been called up will be invoiced by SDC at the end of the call-off period.

Artikel 17 Divisibility of the clauses.

Any total or partial invalidity, nullity, unenforceability or unenforceability of one or more clauses of these general terms and conditions does not affect the validity, enforceability and enforceability of the other clauses or the other part. The parties undertake to replace the clause in question with a valid, enforceable and enforceable clause that is as close as possible to the original intention of the parties.

Artikel 18 Applicable law and competent court.

§1. The legal relationships between the parties are exclusively governed by Belgian law.

§2. (a) In the event of a dispute, the courts of the district where SDC has its registered office shall have exclusive jurisdiction according to their respective substantive jurisdiction.

(b) In addition, only SDC also has the right to bring the dispute to the (domestic or foreign) court that would have jurisdiction if the jurisdiction clause of §2 (a) were not included in these general terms and conditions.