

# The breakout space

is getting  
a promotion

**intuit**  
BY SOFTREND



Office Furniture Collection 2024

# Contents



<b>3</b>	<b>Find your flow with Intuit</b>	<b>66</b>	Kuubik side table
<b>4</b>	How we make work better	<b>68</b>	Link
<b>6</b>	Welcome Zone	<b>72</b>	Manhattan Hexa
<b>8</b>	Social Zone	<b>76</b>	Manhattan Penta
<b>10</b>	Collaboration Zone	<b>82</b>	Meeter
<b>12</b>	Concentration Zone	<b>88</b>	Meeter Chair
<b>14</b>	Things have changed	<b>90</b>	Meeter Round
<b>17</b>	<b>Office Furniture Collection</b>	<b>92</b>	Meeter Sofa
<b>18</b>	Aide	<b>94</b>	Meeter Workbay
<b>20</b>	August	<b>96</b>	Note
<b>26</b>	August Workbay	<b>98</b>	Silent Note
<b>32</b>	August Nook	<b>100</b>	Sans
<b>36</b>	August Wall	<b>110</b>	Sofi
<b>38</b>	Alfred	<b>114</b>	Stand-Up Creative Corner
<b>40</b>	Ben	<b>116</b>	Hubert and Hubert Mini
<b>44</b>	Don	<b>120</b>	Rolf
<b>48</b>	Flow	<b>122</b>	Pouffes Loop, Duo and Twin
<b>50</b>	Frankie	<b>124</b>	Sigmund
<b>56</b>	Grow	<b>126</b>	Spot
<b>58</b>	Hide	<b>130</b>	Cover materials
<b>60</b>	Intro	<b>133</b>	Fabric collection
<b>62</b>	Intuit Booth	<b>134</b>	Standard Fabrics Selection 2023
<b>64</b>	Kuubik	<b>138</b>	Plug-in options



## Find your flow with Intuit

Environment matters. Employees want more from their office than impersonal cubicles. They want spaces that nurture their creativity. Spaces that feel intuitive.

Intuit's designs help you create a living work space – one that teams move through, matching the environment perfectly to their task.

*Agile, creative, collaborative – the spirit of the office breakout space brought out onto the main floor.*

# How we make work better

Our way of working has changed. Doing your best work isn't just about sitting at a desk all day. It's the creative problem solving, agile collaboration, and the feeling of community we search for in the office.

Our designs have evolved to meet this shift. The flexibility and innovation at the heart of each one place intuitive human needs at the center.

*We've taken the spirit of the breakout space and divided it into 4 distinctive work zones - each designed to meet a particular need to encourage collaboration, creativity and connection.*



You'll find products to support the head-down focus of desk work, collaborative spaces that encourage interaction, lounges for socialising, and flexible seating for when people need a break from their desk. Having these varied spaces available encourages employees to work in a way that suits them, and we help you design the perfect flow.

Our 4 work Zones use modular and multi-functional solutions to make the most of every area of the office, giving an agile space that fosters playful creativity - because comfortable employees work better.

The world is moving fast - with Intuit, you make sure office space can keep up.



Welcome Zone



Social Zone



Collaboration Zone



Concentration Zone

# Welcome Zone



## Build an endless sweep of welcome

First impressions are everything. The Welcome Zone is where you put visitors at ease with warm and inviting sofas, and interesting features.

Create a warm Reception for visitors to soak up the atmosphere, an elegant Waiting Lounge for restful moments during a busy day, or a place to socialise, where barriers are broken over a cup of coffee. Set the stage for a positive meeting with Intuit's welcoming aesthetic.



## Reception:

Create a warm and welcoming first impression with our free-flowing modular **Manhattan Hexa** or **Penta** designs. Built to fit together in endless combinations, you can create a space that fits with your company aesthetic.

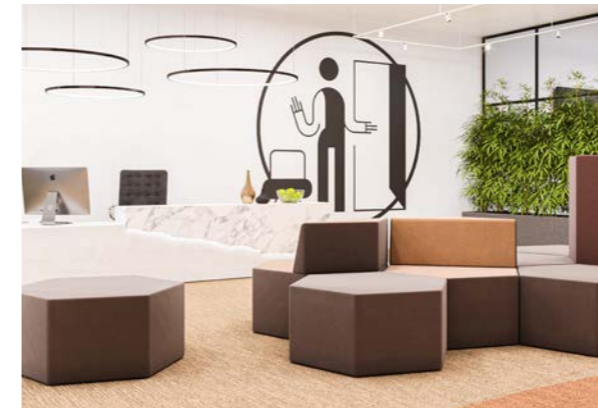

Create your Waiting Lounge with these welcoming products:



Build your Reception with these innovative pieces:

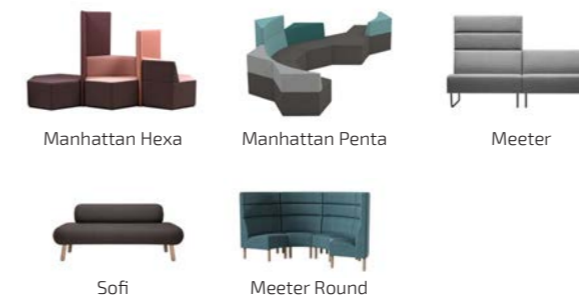

## Hello Coffee:

The world can be fixed over a cup of coffee, so why not weave in opportunities for problem-solving magic through your offices? Take a seat on the **Sans** sofa and brainstorm that tricky issue you've been stuck on with a little help from your friends.



Curate your Hello Coffee space with these warm pieces:



# Social Zone



## Harness the creativity of the hive mind

In our post-Pandemic world, the office also serves as a space where people can get together. When you approach your space with collaboration and socialising in mind, then you create somewhere your employees feel nurtured.

The office shouldn't be a place to power through your to-do list, missing lunch, and then heading home. Unscheduled meetings, and serendipitous connections will create a sense of joint purpose. Use your space to encourage a spirit of fun, and you might just spark the next big idea.



So, branch out from traditional office layouts, and experiment! Providing a choice of work settings, from inclusive lounge spaces to soundproof private discussion areas, will encourage meaningful connections and boost productivity.

## The In-Between Space:

Even the smallest space can lead to fruitful conversations if you plan it the right way. The **August** series of sofas and armchairs with sound-absorbing qualities allow you to create an area to duck out and have those quick one-on-one conversations away from busier working areas.



Build your In-Between Space with these pieces:

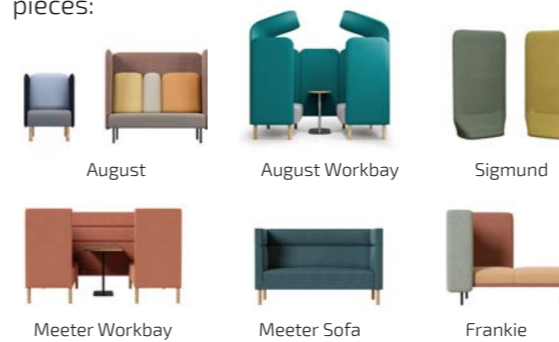

## The Lounge:

Taking breaks is the key to a productive day. So make sure your employees feel nurtured with cosy, homely spaces dotted throughout your offices. Fill them with soft seating, like our **Ben** sofa, and useful tables.



Furnish The Lounge with these comfortable designs:



## Gallery:

Office layouts don't have to be predictable. Our innovative pieces help you create zones that invite connection whatever your restrictions. Use the **August Wall and pouffe** combination to create areas of circulation, where colleagues can have encounters that brighten their day.



Create a Gallery with these innovative products:



# Collaboration Zone



More than half of office workers consider team interaction as the main reason to head to the office.\*

## Tackle your next problem together

If you want to tap into the benefits of connections, then a collaboration space needs to be the focal point of a business.

But it's not just as simple as popping a giant table and a whiteboard in a room and hoping for the best. As the way we interact changes, you'll need to think about how accessible your location is and the technology you need.



\* Source: U.S Workplace Survey Winter 2021

With our designs for the Collaboration Zone, you can create agile touchdown spaces that tap into all the benefits of bringing employees closer together, and supercharge creativity.

## Stand-up:

Not all collaboration needs to be lengthy. When you need to touch base quickly during a project, you don't need to book a whole meeting room for hours. Instead, stand-up spaces can make the most of corner areas using our **Rolf** mobile table and **Hubert** rocking chairs. Share key information quickly, get everyone on the same page, and get on with your day.



Construct your Stand-Up space using these pieces:

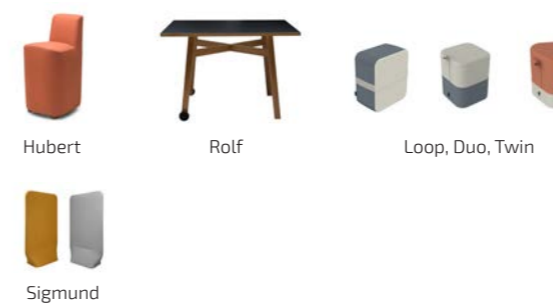

## Studio:

For times when a separate room is necessary, make it as versatile as possible with flexible furniture. Our **Rolf** mobile table and **Hubert** rocking chairs are easily moved around, and perfect for active collaboration sessions.

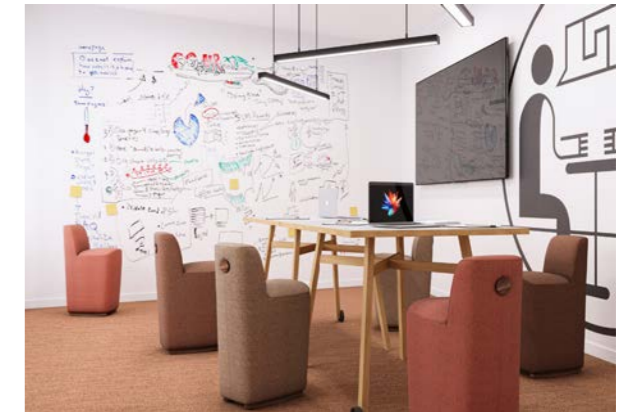

Build your Studio with these flexible designs:



## Living room:

In search of the ultimate versatile space? You need a micro-office. Fulfilling functions as diverse as individual desk work to a relaxed mentoring session, to presenting your next great idea to a small team. A micro-office space makes you feel at home, without feeling isolated.



Curate your Living Room with these intuitive designs:



# Concentration Zone



## Hone in on the task in hand.

Only increased health measures are seen as more important than distraction-free spaces at work. As we transition back to the office, it can be tough to get used to all this background noise again.

Our curiosity-driven design has created products with sound-absorbing qualities, and distraction-busting features. So in the Concentration Zone you'll find innovative ways to create privacy, and tools to enhance focus without feeling isolated. Give workers the gift of concentration – and reap the rewards in productivity.

*Over a third of office workers crave some quiet during the workday, and they're struggling to find it in our open-plan offices.\**



\* Source: U.S Workplace Survey Winter 2021

## Dialogue:

Concentration isn't always a solitary pursuit. When you need 2 sets of eyes on the problem, but you still need to avoid distractions, then the **August** range is your new BFF. Grab your partner in crime and settle in for some serious work.

Have a Dialogue with these innovative designs:



## Nest:

The admin nightmare of trying to book a private room for a delicate conversation can be left far behind with our sound-absorbing **August and Meeter Workbays**. Take advantage of the seclusion between the acoustically shielded walls for a private discussion.



Build a Nest with these creative pieces:

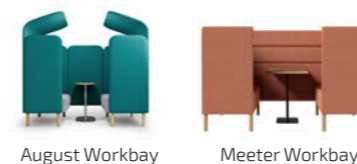

## Secluded cell:

For when perfect focus is needed a Secluded Cell provides. Find peace and quiet within the **August Nook**, whether you're working on something private, or you just need to concentrate with no distractions. Perfect for dotting around the outside of an office, you can create private spaces with minimal effort.



Furnish a Secluded Cell with these focused products:



August Nook

## Phonebooth:

And if your conversation is really private? Then the **Intuit Booth** is your solution. Provide your employees with the space to take private calls – because life is complicated, and we're all a little more used to porous work/home boundaries now.



Intuit Booth



# Things have changed

You may have noticed that there have been a few changes to the office in recent years. Hybrid working, new technologies, health concerns, a constantly evolving economy. Rather than a gentle breeze, a raging storm has turned over the tables and left employers wondering how it all works now. Sure, you could sit back and welcome "the return to normal". You could buy the same old chairs, desks, and whiteboards. But "normal" is not returning.

The focus has changed, bringing the creative vibe of the breakout space out into the rest of the office. This new heart of the office not only increases opportunities for creativity, but also encourages attendance and attracts the best new talent. Who wouldn't want to work in an atmosphere of collaboration and connection?

*We bring a breath of fresh air to the workplace.*

Intuit was created to nurture this atmosphere. We want to help you address the massive change to the office environment. And we want to use our spirit of curious innovation to do it.



## We are here for:

- Curiously exploring and Innovating for the office of the future, and for right now.
- Designing spaces and Creating furniture that intuitively meets your team's needs.
- Supporting the creative and collaborative vibe that will produce the best work.

## Building up from our roots

Intuit was born from Softrend, an established (player) in the upholstered furniture space since 1997. We bring with us Softrend's extensive experience and legacy of creating soft and comfortable furniture. And we're adding our unique dash of curiosity and innovation, so we can upend the world of office furniture.

All our products are handmade in our own Estonian factory. We manage the process from the glimmer in our designer's eye to the finished product. So everything meets our sustainability and quality standards. And we're as agile as we like our products to be, with our small size gifting us flexibility, a personal approach, and the ability to react quickly to what you are asking for. A new wind is blowing...

*From Intuit, you can expect furniture that fits the way things actually work.*

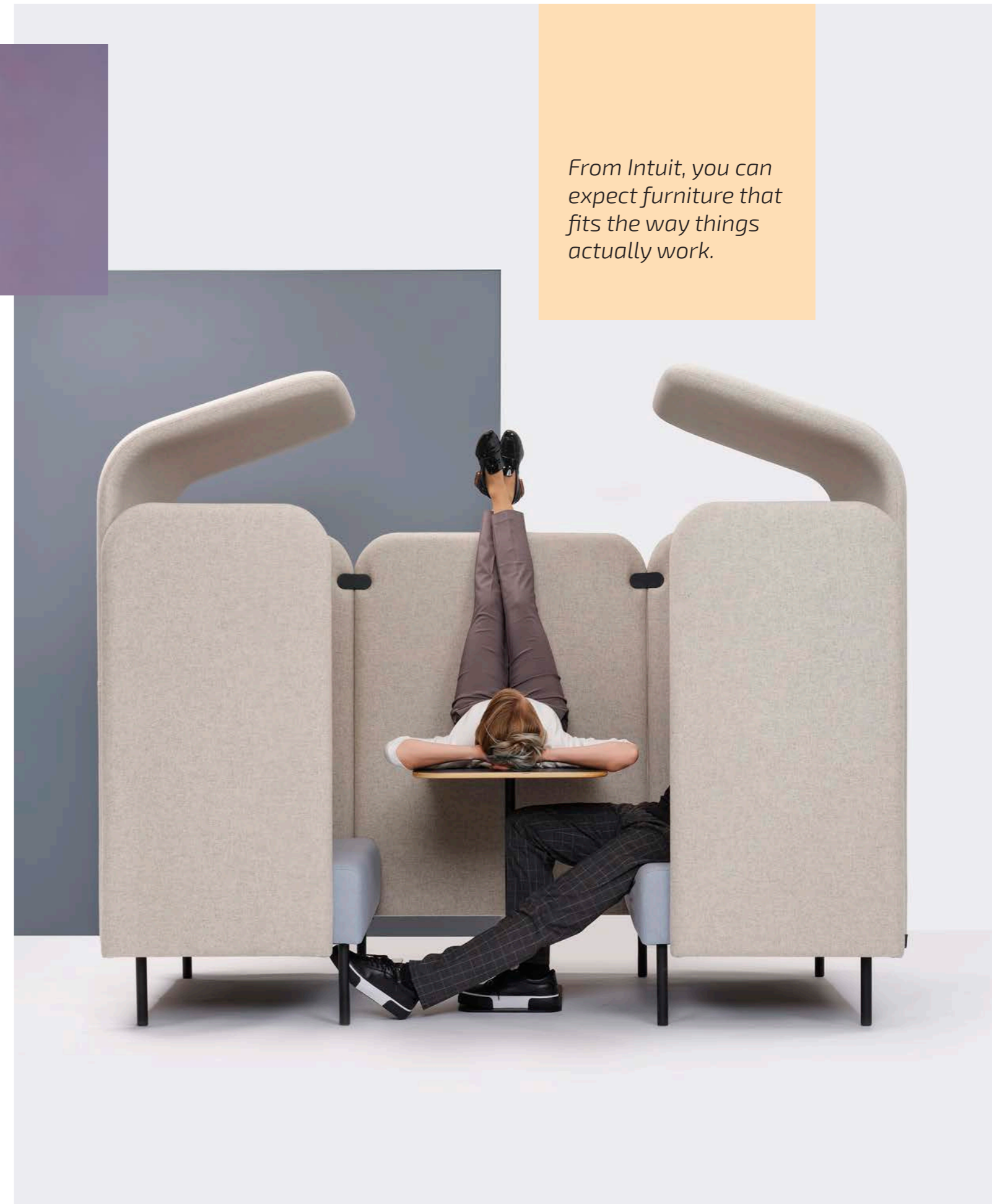

# Office Furniture Collection



# Aide

## Multifunctional table series

Design: Karl Kukkk



5 YEAR  
GUARANTEE



Welcome Zone



Social Zone



Collaboration Zone



Concentration Zone

### A supporting surface that fits everywhere

The Aide table is an indispensable backdrop, designed to complement room layouts and core furniture. The multi-functional table series comprises variations that are tall, low, slender, sturdy, spacious, compact, and offer a combination of features, totalling 7 different versions.

### Suitable for any of the work zones because it

- is easy to combine with other furniture;
- can serve several functions;
- always blends stylishly into the interior.

## Product information

### Top plate

High-pressure laminate: matte black

### Legs

Powder-coated metal, sand structure, matte black RAL 9005

### Base plate

Powder-coated metal, sand structure, matte black RAL 9005

## Dimensions

All dimensions provided in centimetres.

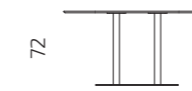
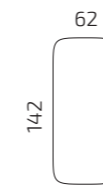

**S128-T3M**

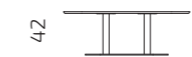

**S128-T3S**

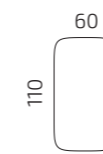

**S128-T1S**

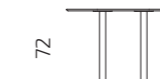

**S128-T1M**

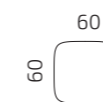

**S128-T4S**



**S128-T4M**

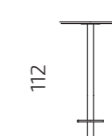

**S128-T4L**

With its timeless and refined appearance, Aide blends into any interior, while maintaining an understated presence, allowing other furniture pieces to take the spotlight. Aide focuses on function adapting to various environments – it can be a coffee table in the lounge area, a dining table in cafes and canteens, a desk in the work zone, or a standing desk across different settings. Finding the perfect solution is easy, as Aide can be integrated with the entire Intuit soft furniture range.

*Support you can't  
live without.*

# August

Sound-absorbing sofa and armchair

Design: Pent Talvet, Iseasi



5 YEAR  
GUARANTEE



FIRE  
RESISTANT  
FABRICS



FIRE  
RESISTANT  
FOAM



FSC  
CERTIFIED  
WOOD  
ONLY



L1  
STRENGTH,  
DURABILITY AND  
SAFETY TEST

AVAILABLE  
AT  
**pCon**  
PLANNER



Social Zone



Concentration Zone

### Designed for the Social and Concentration Zones:

- Encourage focus and seclusion
- Host private meetings
- Divide your space organically
- Cut down on background noise



### Meet the office sofa of the future.

Sound absorbing qualities make the August range a perfect choice for your intuitive workplace, providing the levels of sanctuary needed at different points in the day. And the chic design keeps your office aesthetic as fresh and dynamic as your team members! The functional nature of the August has been packaged in a compact, modest form that's designed to fit in with any interior.

The epitome of our agile ethos, the August sofa and armchair is available in 3 heights.

For your Social Zone the H1 and H2 sizes invite you to sit down with a friend and catch up on the day. For your Concentration Zone, the H3 design creates an island of privacy where you can hold mini-meetings, delve into paperwork or make important phone calls within a busy office.

Find your perfect mix with August.

### Product information

Applies to all August series products

#### Plug-in option

See pages 138-139

#### Frame

Solid wood and plywood

#### Seat & backrest

Durable and fireproof HR-foam; fixed seat and back cushions

#### Legs

**1. Solid oak** (metal & timber frame); finishing options that can be ordered separately at customer's request: solid ash, stained and varnished

**2. Powder-coated metal legs;** anti-slip soles

**3. 360° rotating leg, powder-coated metal;** for model 1-5

#### Additional information

The cover fabric is not removable; sides and rear wall of H3 models: only felt cover fabric

#### Accessories

##### Additional table T1/T3

Material: innovative Valchromat mdf, high-pressure laminate; frame: powder-coated metal

##### Additional table T2

Material: innovative Valchromat mdf, high-pressure laminate; frame: powder-coated metal  
Table can be moved; 360° rotating laptop table.  
See pages 130-131

#### Standard Fabric Collection

See pages 134-137





1-S/ H1



1-S/ H2



1-S/ H3



2-S/ H1



2-S/ H2



2-S/ H3



2,5-S/ H1



2,5-S/ H2



2,5-S/ H3



3-S/ H1



3-S/ H2



3-S/ H3

## Dimensions

Seat depth: 48 cm  
Seat height: 45 cm

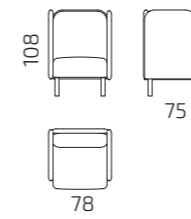

1-S/ H1

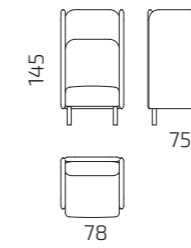

1-S/ H2

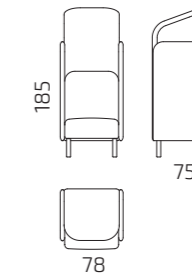

1-S/ H3

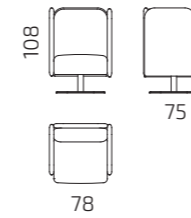

1-S/ H1/ L3

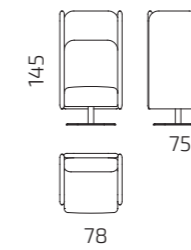

1-S/ H2/ L3

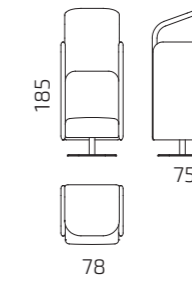

1-S/ H3/ L3

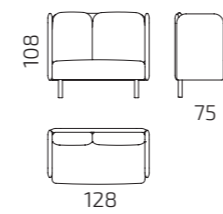

2-S/ H1

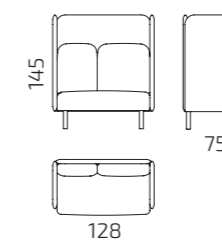

2-S/ H2

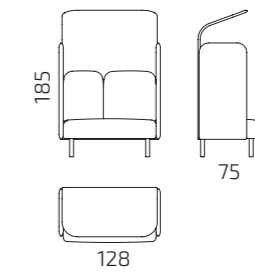

2-S/ H3

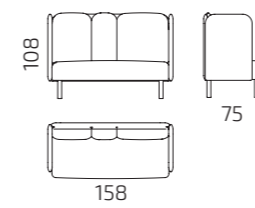

2,5-S/ H1

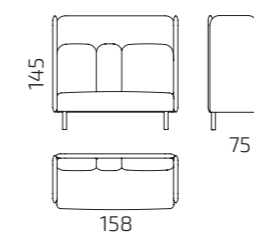

2,5-S/ H2

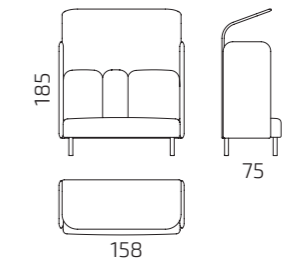

2,5-S/ H3

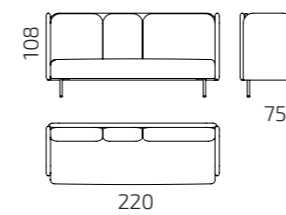

3-S/ H1

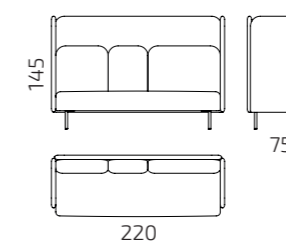

3-S/ H2

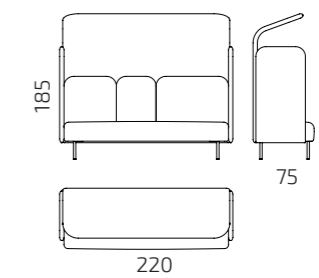

3-S/ H3

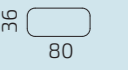

T-1

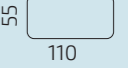
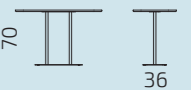

T-3

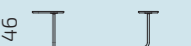

T-2

All dimensions provided in centimetres.



# August Workbay

Sound-absorbing workstation



5 YEAR  
GUARANTEE



FIRE  
RESISTANT  
FABRICS



FIRE  
RESISTANT  
FOAM



FSC  
CERTIFIED  
WOOD  
ONLY



L1  
STRENGTH,  
DURABILITY AND  
SAFETY TEST

AVAILABLE  
AT  
**pCon**  
PLANNER



Collaboration Zone



Concentration Zone

## Designed for the Collaboration and Concentration Zone:

- Give the option of focus and seclusion
- Hold your own private meeting
- Divide your space organically
- Cut down on background noise

## Looking for the perfect spot to have that important conversation?

The August sofa set provides an easy solution for creating a workbay where you can go to get some privacy or have meetings. The August Workbay is an integral part of your Concentration Zone, providing an opportunity to step away from the noise, and find the focus you need.

The only thing it takes is to connect two roofed Augusts with a partition wall. Sound-absorbing qualities make it easy to carve out a space of peace and quiet within an open-plan office. Distraction-busting high sides give you the focus you need to unravel a tricky problem with a colleague. Its compact and modular style means that the Workbay can be placed in islets, rows, or whatever works best for your Concentration Zone.



*Shut the world away, and unlock your productivity.*

## Product information

### Plug-in option

See pages 138-139

### Frame

Solid wood and plywood

### Seat & backrest

Durable and fireproof HR-foam; fixed seat and back cushions

### Wall fastenings

Material powder-coated metal

### Legs

**1. Solid oak** (metal & timber frame); finishing options that can be ordered separately at customer's request: solid ash, stained and varnished

**2. Powder-coated metal** legs; anti-slip soles

### Additional information

The cover fabric is not removable; sides and rear wall of H3 models: only felt cover fabric

### Accessories

#### Additional table T1/T3

Material: innovative Valchromat mdf, high-pressure laminate; frame: powder-coated metal. See pages 130-131

### Standard Fabric Collection

See pages 134-137

## Dimensions

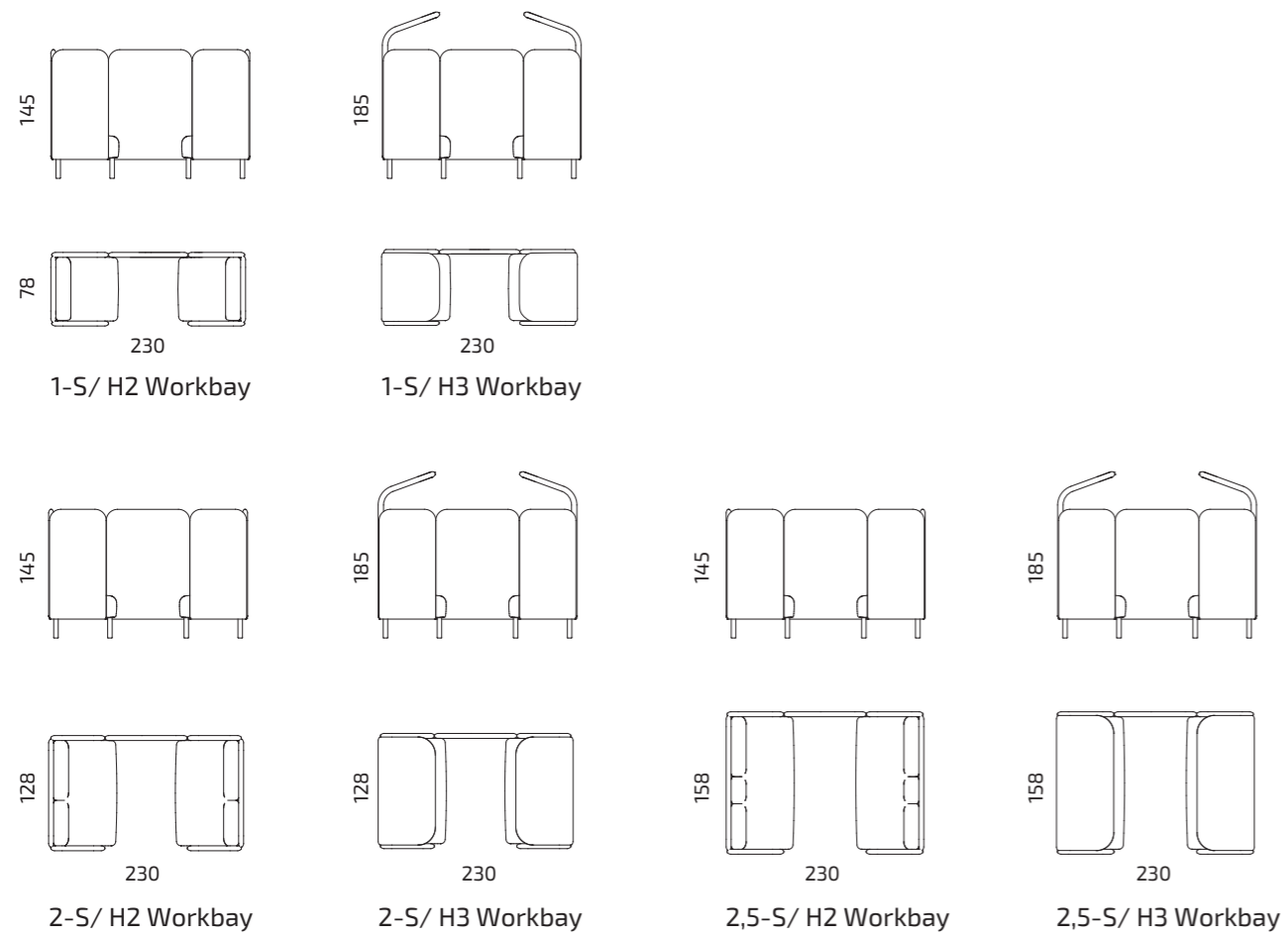

All dimensions provided in centimetres.

## Dimensions

**Choose Workbay wall option:  
regular or with plug-in option**

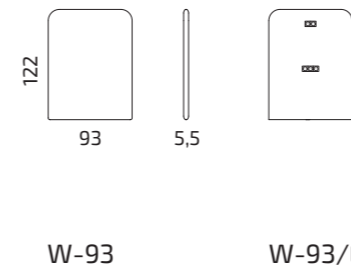

**Choose Workbay table option:**

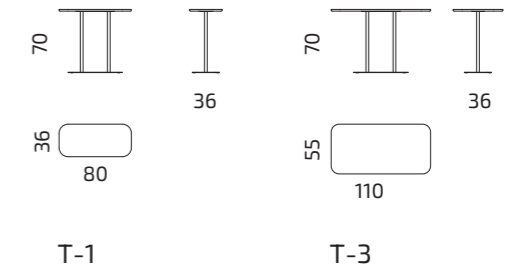

## Plug-in options



- 220V socket and
- HDMI socket/output for TV screen
- HDMI cable inside the wall to connect the input and output

- USB Charger Type A
- HDMI socket/input from computer
- 220V socket for computer





# August Nook

Sound-absorbing workstation

Design: Pent Talvet, Iseasi



5 YEAR  
GUARANTEE



FIRE  
RESISTANT  
FABRICS



FIRE  
RESISTANT  
FOAM



L1  
STRENGTH,  
DURABILITY AND  
SAFETY TEST



FSC  
CERTIFIED  
WOOD  
ONLY

AVAILABLE  
AT  
**pCon**  
PLANNER

## Let's turn the normal hot desk on its head.

How do you provide a welcoming space for your hybrid workers? You need the compact 3-in-1 August Nook, with its built-in laptop size table, comfortable seat, and sound-absorbing screens.

Inviting you into a secluded spot that encourages focus and deep work, the Nook is somewhere you can slip into for an hour, or hang out in all day. Everything you need, all in one streamlined space.



## Designed for the Concentration Zone:

- Encourage focus and seclusion
- Divide your space with ease
- Cut down on background noise

## Dimensions

### Left or Right handed

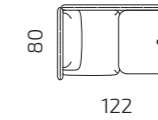
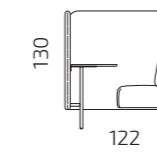
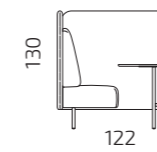
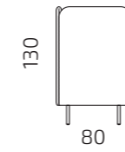

Seat depth: 48 cm  
Seat height: 45 cm

### Integrated plug-in option in the tabletop

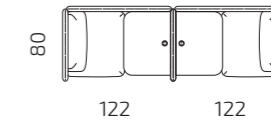
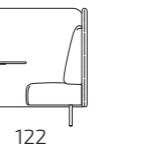
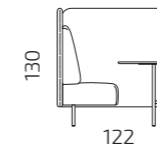
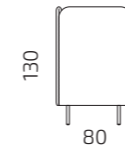

All dimensions provided  
in centimetres.

## Product information

### Plug-in option

See pages 138-139

### Frame

Solid wood and plywood

### Seat & backrest

Durable and fireproof HR-foam;  
fixed seat and back cushions

### Table

Material: innovative Valchromat mdf, high-  
pressure laminate; frame: powder-coated metal.  
See pages 130-131

### Legs

1. **Solid oak** (metal & timber frame);  
finishing options that can be ordered separately  
at customer's request: solid ash, stained and  
varnished
2. **Powder-coated metal** legs;  
anti-slip soles (optional)

### Additional information

The cover fabric is not removable

### Standard Fabric Collection

See pages 134-137



Concentration Zone



# August Wall

Sound-absorbing wall panelling and pouffe

Soft August Wall panels with a separate pouffe add a playful touch to the August range. Sound-absorbing panels help improve the acoustic properties of open rooms. Use the August Wall and pouffe combination to create areas of circulation, where colleagues can have encounters that brighten their day.



5 YEAR GUARANTEE



FIRE RESISTANT FABRICS



FIRE RESISTANT FOAM



FSC CERTIFIED WOOD ONLY

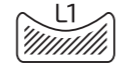

L1 STRENGTH, DURABILITY AND SAFETY TEST

AVAILABLE AT  
**pCon**  
PLANNER



Welcome Zone



Social Zone

## Designed for the Welcome and Social Zones:

- Make your visitors feel at home
- Make connections with colleagues
- Cut down on background noise

## Dimensions

All dimensions provided in centimetres.

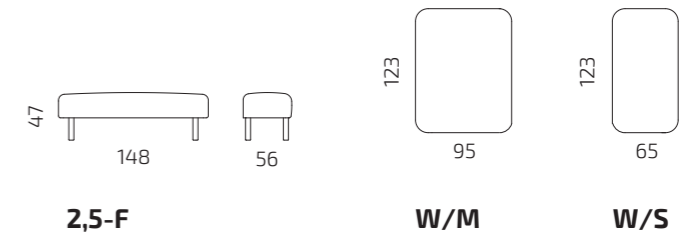
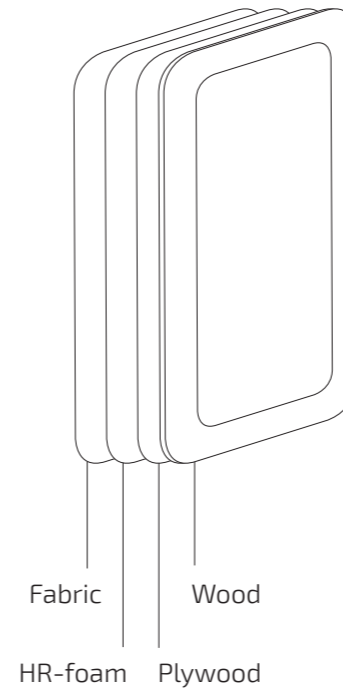

2,5-F

W/M

W/S

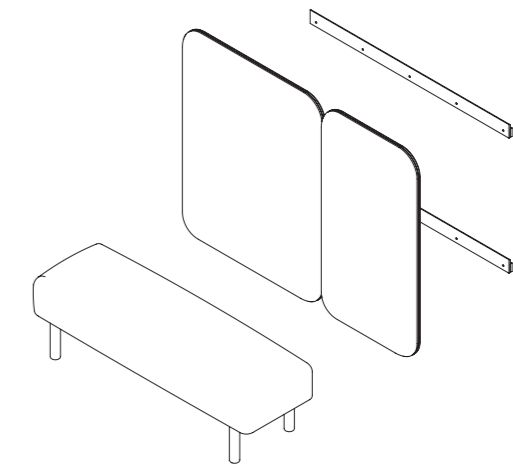

Seat depth: 48 cm

## Product information

### Plug-in option

See pages 138-139

### Frame

Solid wood and plywood

### Seat & backrest

Durable and fireproof HR-foam; fixed seat and back cushions

### Legs

1. **Solid oak** (metal & timber frame); finishing options that can be ordered separately at customer's request: solid ash, stained and varnished

2. **Powder-coated metal** legs; anti-slip soles

### Additional information

The cover fabric is not removable

### Accessories

#### Additional table T1/T3

Material: innovative Valchromat mdf, high-pressure laminate; frame: powder-coated metal

#### Additional table T2

Material: innovative Valchromat mdf, high-pressure laminate; frame: powder-coated metal  
Table can be moved; 360° rotating laptop tab

### Standard Fabric Collection

See pages 134-137

# Alfred

## Side table

Design: Argo Tamm

NEW

Give a helping hand  
with Alfred.



5 YEAR  
GUARANTEE



FSC  
CERTIFIED  
WOOD  
ONLY

### Set it down

Make it easy for your visitors by giving them somewhere to pop their coffee or the piles of notes resting on their lap. The Alfred side table is the perfect height to sit next to Sofi in your Welcome area.

Add its subtle and stylish design to the smaller Social areas you've dotted around the office, and your team can put down their drinks and connect with a quick midday chat.

### Product information

#### Materials

Solid wood oak, powder-coated metal (dark grey)  
finishing: matt varnish

#### Colour options

natural oak, bleached oak, dark oak, wenge.  
See pages 130-131

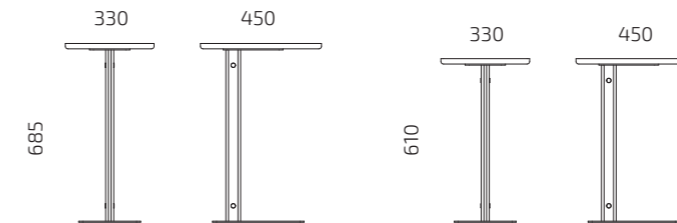

The higher table is also available with large base.



Welcome Zone



Social Zone

### Designed for the Welcome and Social Zones:

- Break up a row of sofas
- Make your spaces inviting and practical



# Ben

Soft office sofa

**Design:** Intuit design team



**Sometimes the best business conversations happen away from the desk.**

Make sure your Social Zone sparks inspiration with the Ben Sofa. With versatile modules, you can create a piece of furniture that perfectly fits your space. And with Ben's springy softness your team will enjoy building connections over coffee. Superior in design and comfort to the breakroom chairs you're used to, Ben shows your team how much you value their comfort and wellbeing. Put the finishing touches to your Social Zone with this inviting sofa.



## Product information

### Frame

High-quality solid wood and plywood, zigzag springs

### Seat and backrest

Durable and fireproof HR foam

### Additional pillows

Feather or fibre filling; two sizes available

### Additional information

The cover fabric is not removable; wide range of cover materials, including flame-retardant textiles

### Standard Fabric Collection

See pages 134-137



MANY DIFFERENT SIZES

MANY COMBINATIONS

FSC CERTIFIED WOOD ONLY

5 YEAR GUARANTEE

FIRE RESISTANT FABRICS

FIRE RESISTANT FOAM

AVAILABLE AT **pCon** PLANNER



Social Zone

### Designed for the Social Zone:

- Make connections with colleagues
- Take a break
- Grab moments of rest
- Make your visitors feel at home



## Example combinations

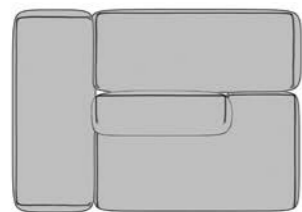
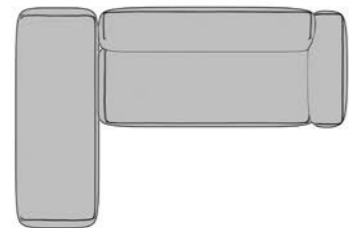
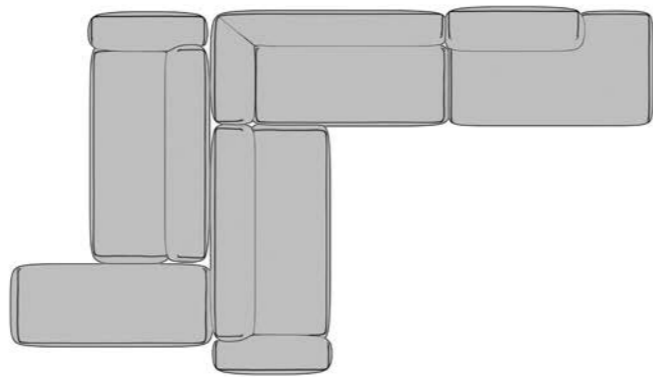
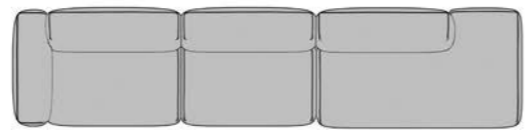
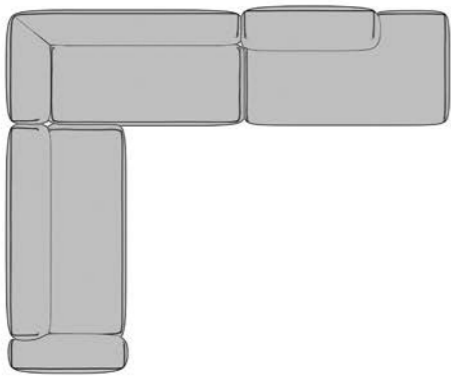
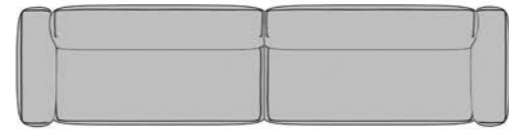

## Dimensions

84	152 94	194 148	173 98 50	173 50 98
71				
	<b>S120-S1.5</b>	<b>S120-S2</b>	<b>S120-1SDRKTR</b>	<b>S120-1SDLKTR</b>
84	125 98	173 148	173 148	148 50 98
71				
	<b>S120-15CL</b>	<b>S120-2CL</b>	<b>S120-CL</b>	<b>S120-1SDL</b>
84	98	148	148	98 50
71				
	<b>S120-15CR</b>	<b>S120-2CR</b>	<b>S120-CR</b>	<b>S120-1SDR</b>
84	98 98	148 148		
71				
	<b>S120-15</b>	<b>S120-2</b>		
84	98	148	98	148
	<b>S120-F1</b>	<b>S120-F2</b>	<b>S120-F3</b>	<b>S120-F4</b>

All dimensions provided in centimetres.

# Don

Soft office sofa

**Design:** Intuit design team



*Don – honorary citizen in the lounge.*

## A moment of rest worthy of its name

While the lounge couch Ben serves as the focal point of the Social Zone, creating a comfortable space for colleagues to take a break from work, its larger counterpart, Don, elevates these breaks to a whole new level.

Don is as springy and as elegantly designed as Ben, but with a slightly deeper seating area, which adds a luxurious look and makes things more comfortable. Now everyone can get cosy and enjoy lying down, including four-legged members of the office.



MANY DIFFERENT SIZES

MANY COMBINATIONS

FSC CERTIFIED WOOD ONLY

5 YEAR GUARANTEE

FIRE RESISTANT FABRICS

FIRE RESISTANT FOAM



Social Zone

## Designed for the Social Zone, as it:

- is a great place to befriend colleagues
- offers a spacious and comfortable seating area
- makes guests feel at home



## Product information

### Frame

High-quality solid wood and plywood, zigzag springs

### Seat and backrest

Durable and fireproof HR foam

### Additional pillows

Feather or fibre filling; two sizes available

### Additional information

The cover fabric is not removable; wide range of cover materials, including flame-retardant textiles

### Standard Fabric Collection

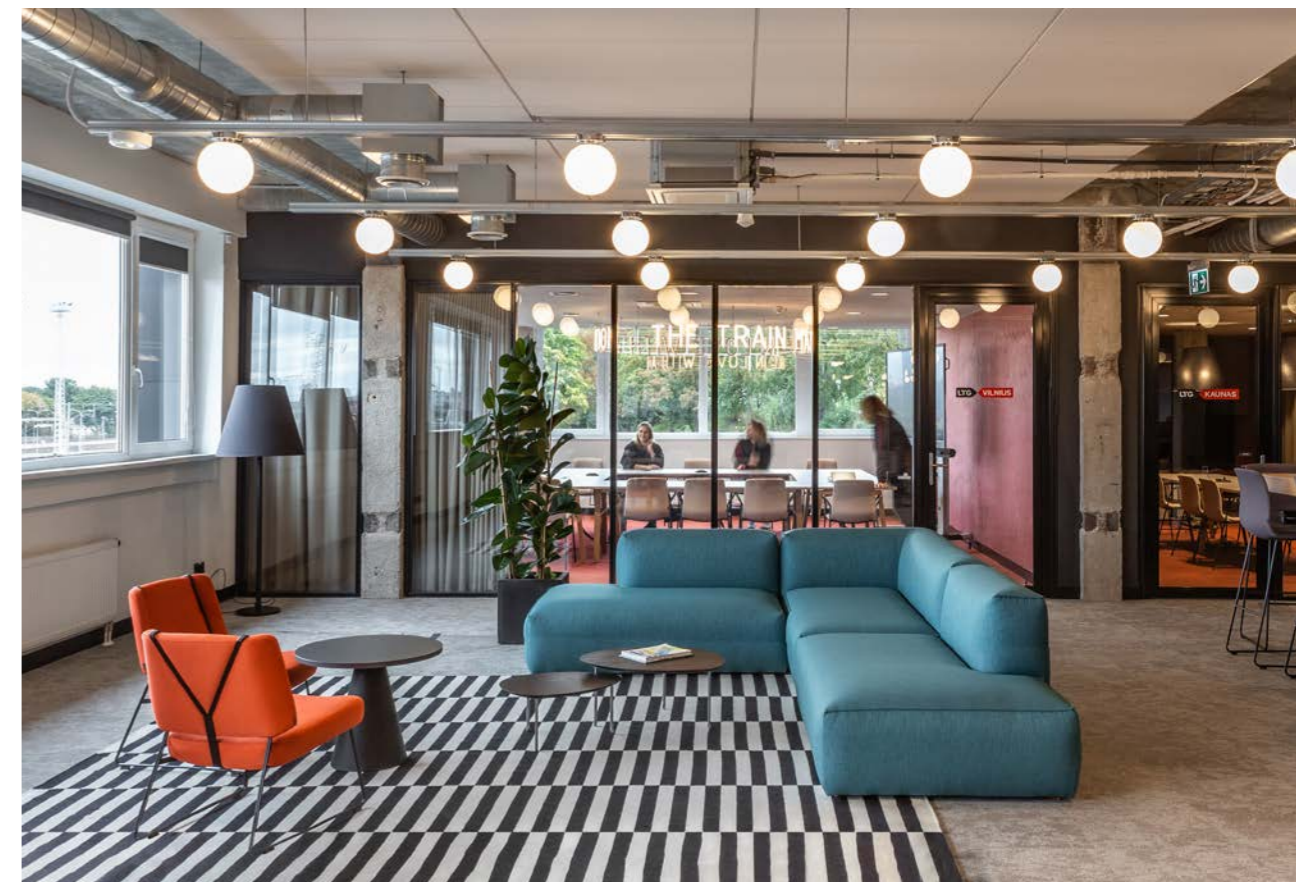



## Example combinations

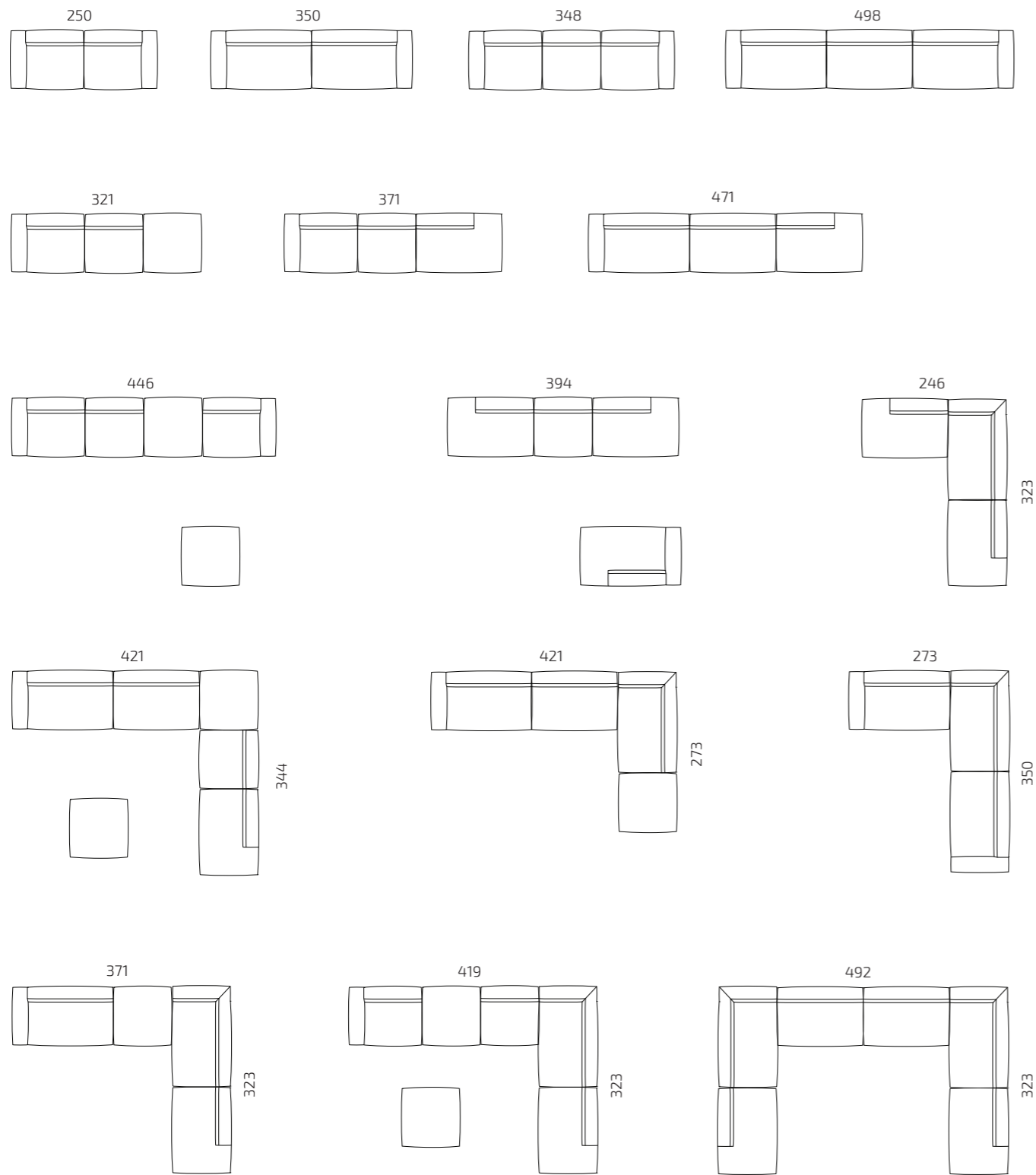

## Dimensions

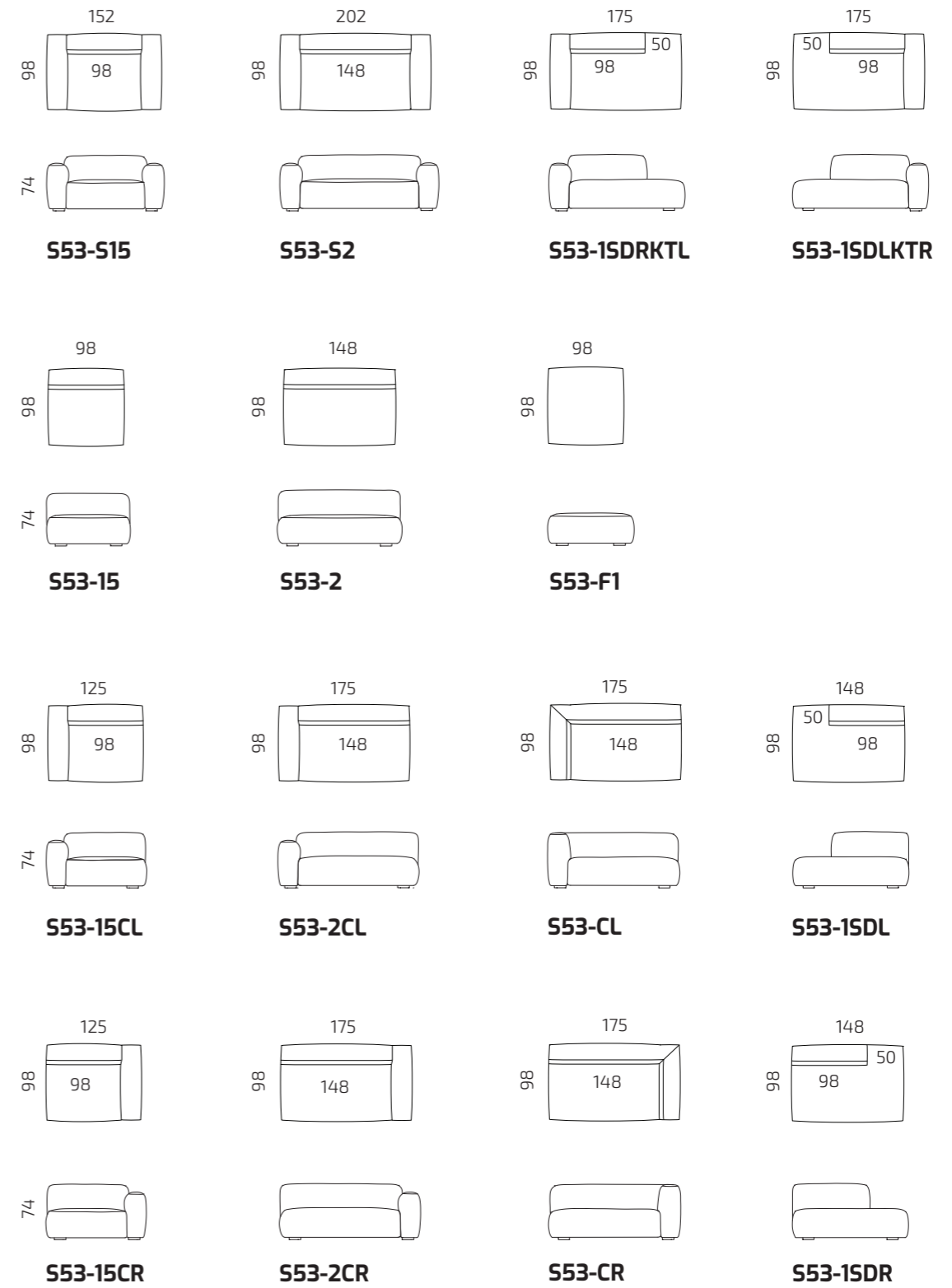

All dimensions provided in centimetres.

# Flow

## Shared office desk

Design: Martin Pärn / Janne Nõu, Iseasi



5 YEAR  
GUARANTEE



FSC  
CERTIFIED  
WOOD  
ONLY

No one feels  
redundant.

### The more the merrier

Sometimes, only a few people come into the office and the room feels empty. Other times, when everyone is there – management, busy bees, guests – it could get a little crowded. With Flow, a shared office desk, neither loneliness nor a lack of space is never an issue.

Flow is the social centre of the room, providing an equally welcoming haven for colleagues without a fixed desk as well as for groups holding meetings. The hidden sockets in the table's shelf supports enable one to be productive. It is also an ideal place for team lunches and casual chats. Flow stands without screws on stylish trestles, allowing you to effortlessly give the room a different look with a reversible two-tone tabletop.



## Product information

### Top board

1. Fenix high-pressure laminate / Forbo desktop linoleum; natural oak edge band
2. High-pressure laminate; ABS oak edge band  
Table top board can optionally be ordered to be used one or two sided

### Legs

Solid oak

### Metal parts

Powder-coated, sand texture, matte; wine red RAL 3005 or black RAL 900

### Under table screen

Recommended material: felt - Blue Kompany Dama or Nevotex Wooly

### Plug-in option

Integrated electric outlet: 2x Powerdot Mini 50 (black) 220W (EU, FR)  
Optional: 2x Avolt Square-1 (black): 3x 220W (EU, FR); 2x USB-C (30W); 1,8m cable



## Dimensions

All dimensions provided in centimetres.

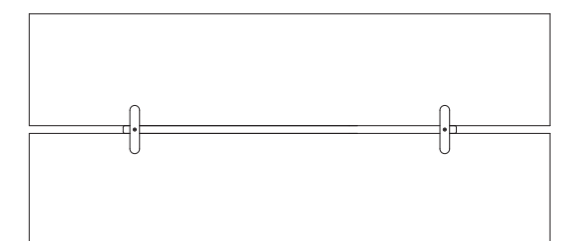
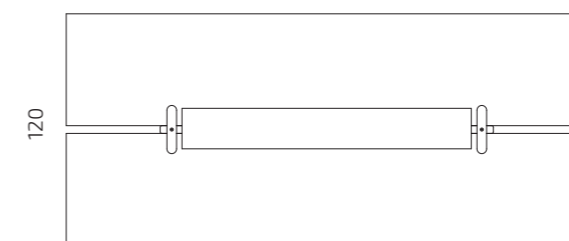
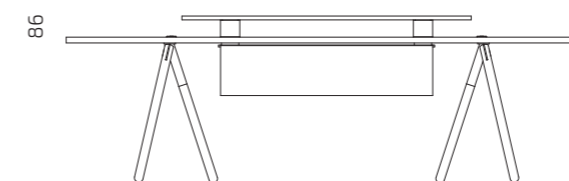

270



Collaboration Zone



Social Zone

### Suitable for the Social and Collaboration zones because it:

- brings people together;
- complements an otherwise empty space;
- functions as both a work and a meeting table.

1. **Table: S127-TF270** (Fenix/Forbo)  
**Shelf and screen: S127-TRF** (Fenix/ Forbo)
2. **Table: S127-TL270** (high-pressure laminate)  
**Shelf and screen: S127-TRL** (high-pressure laminate)

1. **Table: S127-TF270** (Fenix/Forbo)
2. **Table: S127-TL270** (high-pressure laminate)

# Frankie

## Work sofa

**Design:** Argo Tamm

-  MANY DIFFERENT SIZES
-  MANY COMBINATIONS
-  CERTIFIED WOOD ONLY
-  5 YEAR GUARANTEE
-  FIRE RESISTANT FABRICS
-  FIRE RESISTANT FOAM
-  L1 STRENGTH, DURABILITY AND SAFETY TEST
- AVAILABLE AT 

Combine Frankie's elements to create private workspaces in your Concentration Zone or larger spaces for vibrant conversation.

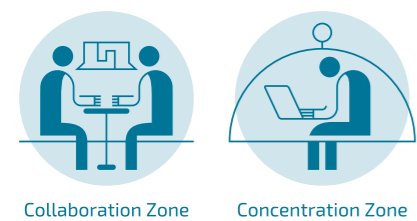

### Designed for the Collaboration and Concentration Zones:

- Create focus and seclusion
- Host your own private meeting
- Divide your space organically
- Encourage rest

### Harness form, function, and flexibility

The slender and versatile Frankie embodies Intuit's agile ethos. With options of a sofa, armchair, and extended bench your imagination is the only limit. The set includes moving tables: a smaller one with space for a computer, mug or magazine and a larger one in which there are power sockets for charging devices.

Find your sweet spot with Frankie.



## Product information

### Plug-in option

See pages 138-139

### Frame

Metal, solid wood and plywood

### Upholstery

Seats have high-elastic durable HR foam with FR certification

### Small extra pillow

Feather filling

### Legs

Powder-coated metal; anti-slip soles

### Additional information

Wide range of cover materials, including flame-retardant textiles

### Accessories

#### Additional table T-330

**Material:** innovative Valchromat mdf, high-pressure laminate. See pages 130-131

**Frame:** powder-coated metal

Table can be moved; 360° rotating laptop table

### Standard Fabric Collection

See pages 134-137



2S+2WL+2WR



2S+3WL+3WR



2S+3WL+2WR



2S/2WR+2WR



1S+2WL



1S+3WL

Example combinations





## Dimensions

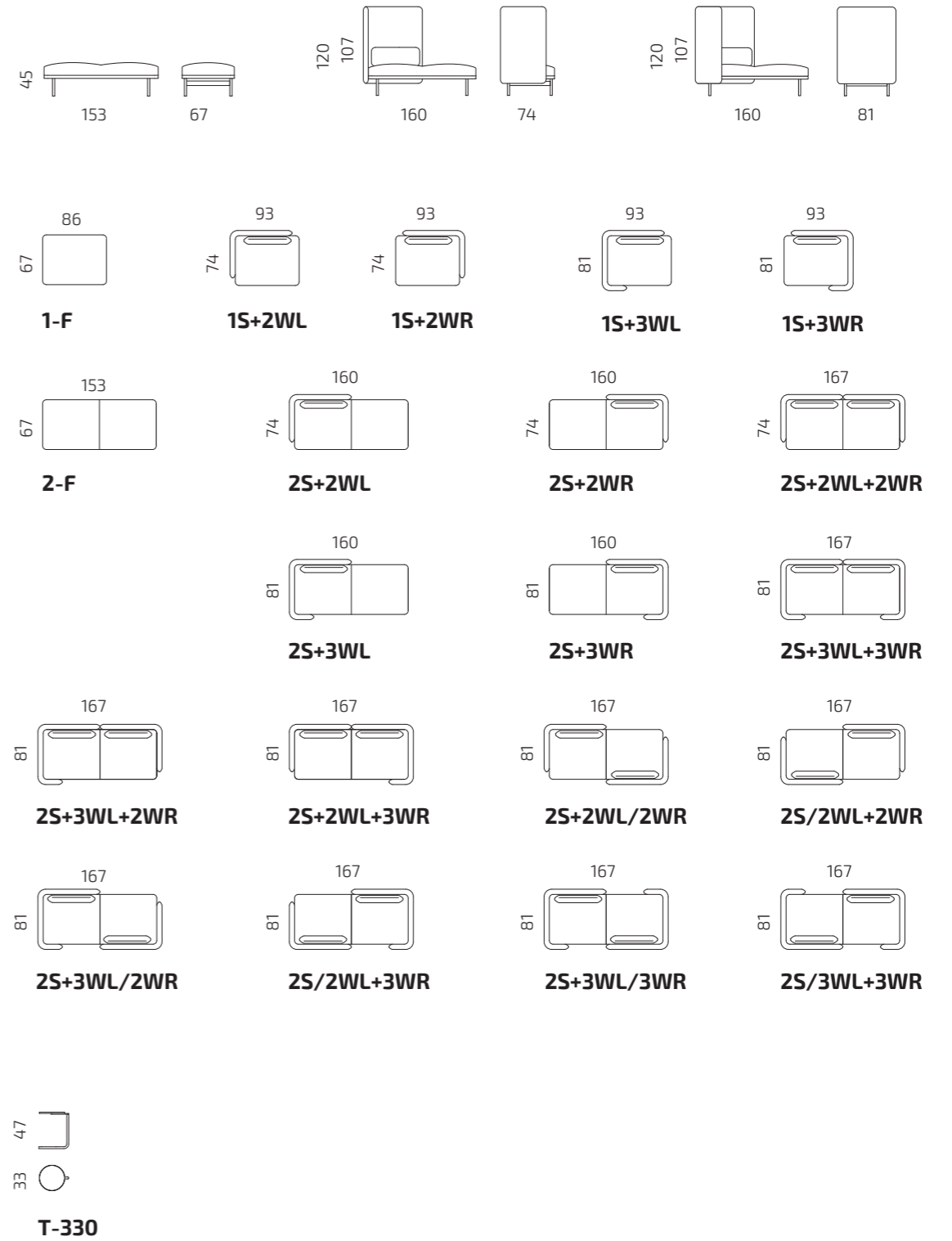

All dimensions provided in centimetres.

# Grow

## Mobile plant divider

Design: Lauri Visnapuu



5 YEAR  
GUARANTEE



FIRE  
RESISTANT  
FABRICS



GOOD SOUND-  
ABSORBING  
QUALITIES



*Make happiness in  
workplace grow again.*

### A peaceful green hideaway

Transform your office into a lush forest and show that you care. Use flowerpots of two different heights as clever space dividers to close yourself off from the endlessness of the open office floor plan. The 360-degree rotating wheels allow you to give your office space a new floral face-lift, anytime.

Order these mobile plant dividers, cleverly lined with acoustic foam and optionally covered in acoustic felt on all sides, to muffle noise and create a soothing environment for employees. Or opt for a more multifunctional design that puts a spacious shelf on one side.



Welcome Zone



Social Zone



Collaboration Zone



Concentration Zone

### Universal design for all work zones:

- Bring greenery into the office
- Create a homey atmosphere
- Separate work zones and corridors
- Construct inspiring private spaces
- Improve office acoustics

## Product information

### Walls

Laminated MDF (oak, white, black), lined with acoustic foam and covered with acoustic felt from one or both sides upon request.

### Shelving (on models with shelves)

Laminated MDF (oak, white, black)

### Plant box

Powder coated waterproof steel

### Legs

Powder coated steel tube; 360° rotating and lockable wheels

### Standard Fabric Collection

See pages 134-137



## Dimensions

### Mobile plant divider without shelves

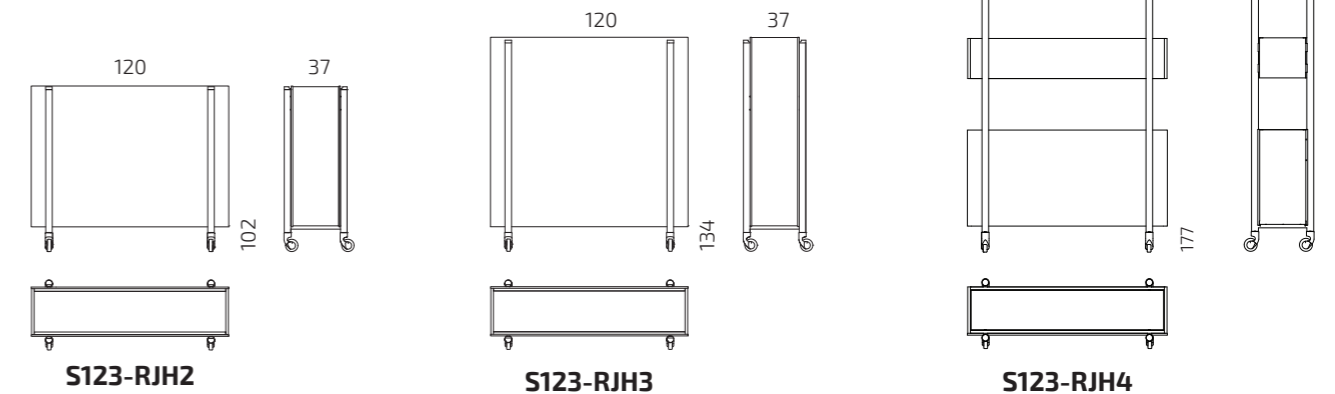

### Mobile plant divider with shelves

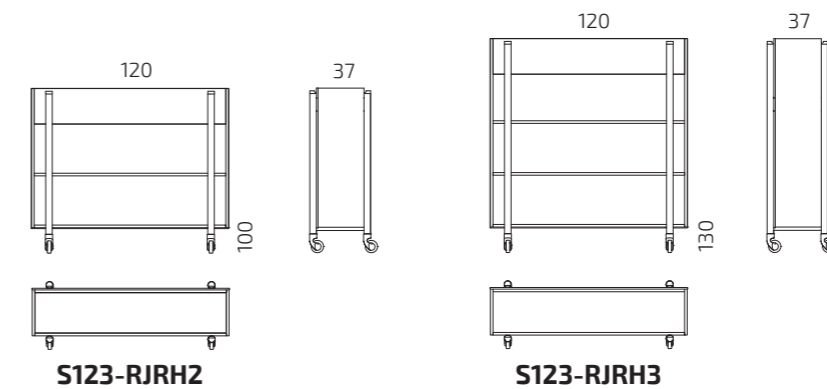

All dimensions provided in centimetres.

# Hide

## Mobile office armchair

**Design:** Pent Talvet, Iseasi



5 YEAR  
GUARANTEE



FIRE  
RESISTANT  
FABRICS



FIRE  
RESISTANT  
FOAM

*Work from a comfy couch  
in solitude, away from  
judgmental eyes.*

### A cozy nest in the middle of the office

Some tasks demand a different level of immersion. Some require that you get up from your desk, grab your laptop and slip into a more comfortable corner to allow your thoughts room to roam. The Hide has been specifically designed to be a soft nest to which office nomads can retreat.

Thanks to its modular design, the seat, screen and support surface can be positioned on the frame in multiple directions. Its mobility means that the Hide can be easily repositioned in whichever way you need it, whether it be facing an inspiring view from a window or turning away from the noisy office crowd.



### Designed for the Concentration Zone:

- Makes for a perfect hideaway
- Creates a homey atmosphere



Concentration Zone



## Product information

**Frame**  
Plywood

**Seat & backrest**  
Durable and fireproof HR-foam

**Legs**  
Powder coated steel

**Additional information**  
The cover fabric is not removable

**Accessories**  
Side table for width 1: Solid wood  
Side shelf for width 1,5: Solid wood,  
veneered chipboard

**Standard Fabric Collection**  
See pages 134-137

## Dimensions

Seat height: 40 cm

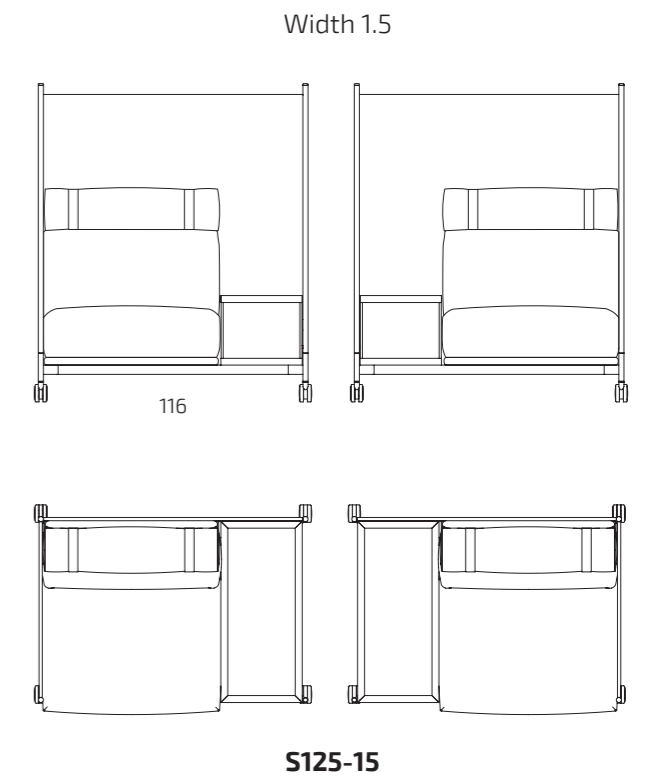
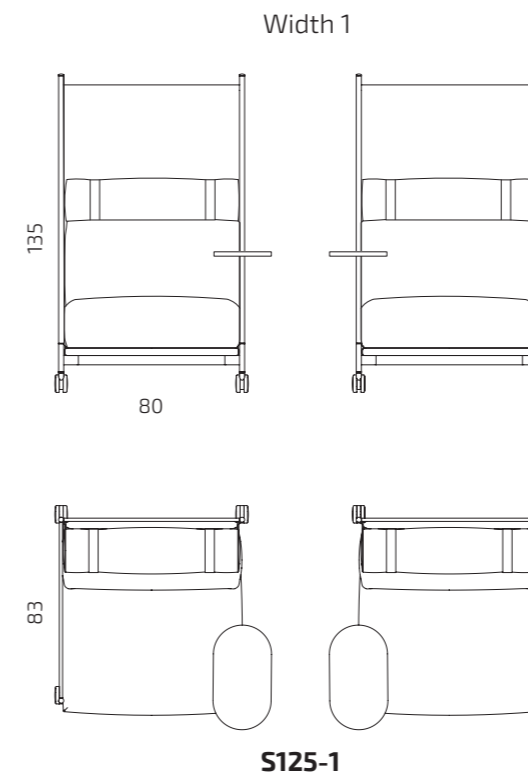

All dimensions provided in centimetres.

# Intro

## Lounge chair

**Design:** Argo Tamm



5 YEAR  
GUARANTEE



FSC  
CERTIFIED  
WOOD  
ONLY



FIRE  
RESISTANT  
FABRICS



*Take up less room.*



Not every office can cater for sprawling sofas and ping pong tables. But don't despair! If you're looking to create a flexible area for building community and encouraging relaxation, then we have what you need.

Compact, minimalist, oh so comfortable, Intro is easy to sink into with a cup of steaming coffee. And with its streamlined proportions you have an elegant solution to your space constraints.

### Product information

#### Frame

Metal

#### Upholstery

high resiliency moulded PU foam

#### Legs

Black / oak

#### Additional information

The cover fabric is not removable; wide range of cover materials, including flame-retardant textiles

#### Standard Fabric Collection

See pages 134-137

### Dimensions

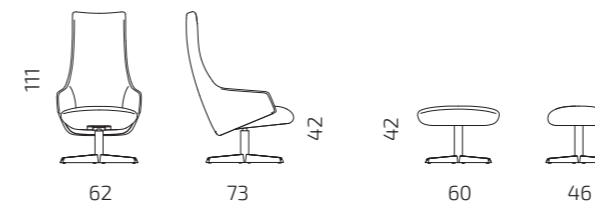

**S64-S1**

**S64-F1**

All dimensions provided in centimetres.

#### Designed for the Social Zone:

- Make connections with colleagues
- Take a welcome break from your desk
- Make your visitors feel welcome



Social Zone





# Intuit Booth

Phonebooth

Design: Iseasi

NEW

*Ditch the distractions with Booth.*



Concentration Zone



5 YEAR GUARANTEE



FIRE RESISTANT FABRICS



FIRE RESISTANT FOAM



GOOD SOUND-ABSORBING QUALITIES

AVAILABLE AT  
**pCon**  
PLANNER

## Deliver quiet with Booth

You need to make a call. But you'd rather the whole office didn't listen in. Booth provides a quiet oasis, so you can focus on your conversation, without distractions.

We saw an opportunity to make the basic phone booth a much more pleasant place to be. If you've spent time in cramped and claustrophobic phone booths before, you'll marvel at how Booth opens up the space. Its special trapezoid design enhances your cognitive comfort, while eliminating annoying echoes. And its rocking and rotating seat gives you room to move, without banging your elbows on the walls every 5 seconds.

Booth harnesses technology and design to provide an intuitive space for your special task. With sound absorbing upholstery and acoustic panels, Booth dampens noise from every direction. Its motion sensor fresh air ventilation system and adjustable LED lighting help you create exactly the environment you work well in. While its wheels mean you can relocate it to anywhere in your office.

## Designed for the Concentration Zone:

- Enjoy a room that feels bigger on the inside
- Take calls without disturbing your team
- Find the peace you need

## Cover materials

**Outside:** Soft upholstered wall panels and interior ceiling panel covered with certified acoustic and fire-retardant felt. Standard selection:



Full Intuit House Fabric Collection available on request. See pages 134-137

**Inside:** Wall panel cover is available in certified acoustic and fire-retardant material. Standard selection:



**Floor:** Floor cover is available in 2 colors in a fishbone pattern. Standard selection:



## Dimensions

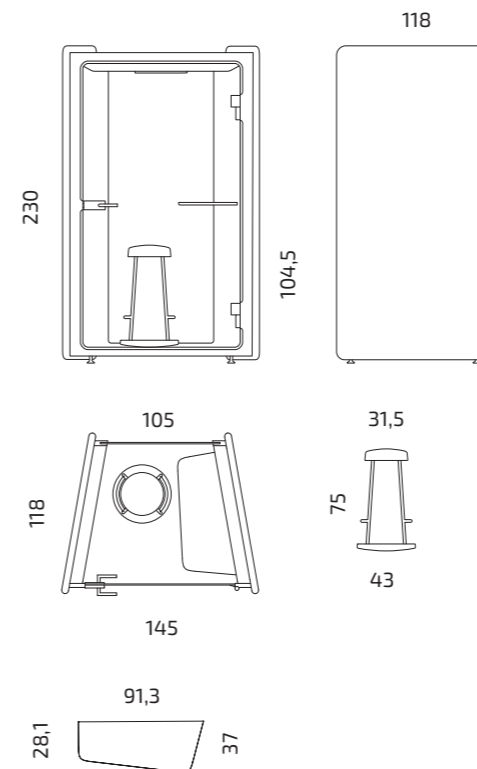

All dimensions provided in centimetres.

## Product information

### Structure

High-quality plywood, painted black

### Materials

**Outside:** soft upholstered panels covered with certified acoustic and fire-retardant felt

**Inside:** ceiling and wall panels covered with certified acoustic and fire-retardant felt and fabric

**Table:** black high pressure laminate

**Glass door and back wall:** tempered glass panel, equipped with certified acoustic foil

### Additional information

**Acoustics:** A-class sound reduction

**Electrification:** Mains power outlet 220W. USB chargers (5A, type A and C) on request

**Movable:** On four wheels underneath, floor adjusters are integrated for levelling

### Integrated ventilation

Airflow rate: when occupied 40l/s; stand-by mode, after 5 mins no occupancy 27 l/s

### Accessories

Bar height perch, 360 swivel and rocking



## More Space

Booth's trapezoid shape is especially designed to feel spacious. It enables you to choose different positions. Its wide glass panels help you feel part of your wider surroundings, without being disturbed by them. And make the whole booth full of light. You can swing and turn on your chair, adapting your setup to whatever you need to work on.

# Kuubik

## Sofa table

**Design:** Argo Tamm



5 YEAR  
GUARANTEE

Lay it all down  
with Kuubik.

### Make it easy

Kuubik is no ordinary table. Its modern cube design means it doesn't impose on its environment. While its range of colors gives you options to fit your office aesthetic.

Use Kuubik to divide up the seating in your reception area, or place them around the office paired with our compact Intro armchair.



### Product information

#### Materials

##### Top board

Valchromat mdf, veneer  
See pages 130-131

##### Frame

painted metal  
Various tone options

##### Dimensions

Kuubik S: 45 x 45 x H 45 cm  
Kuubik M: 90 x 41 x H 39 cm  
Kuubik L: 82 x 82 x H 34 cm



### Dimensions

All dimensions provided  
in centimetres.

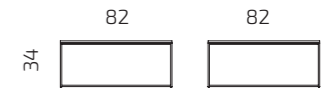
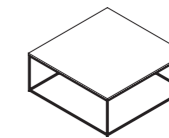

KUUBIK-L

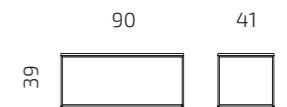
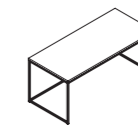

KUUBIK-M/A

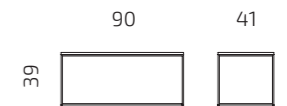
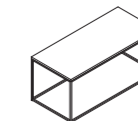

KUUBIK-M/B



KUUBIK-S/A



KUUBIK-S/B



### Designed for the Welcome and Social Zones:

- Encourage inspiring coffee breaks
- Bring a little interest to your reception



Welcome Zone



Social Zone

# Kuubik

## Side table

**Design:** Intuit design team



5 YEAR  
GUARANTEE

Cross every "t"  
and dot every "i"  
with Kuubik.

### Make it comfortable

Kuubik side table is a small table of just the right height and weight to pull over your lap while working with the laptop on the couch. The side table is also a comfortable place next to the sofa to place a cup of coffee or a notebook.

Combine Kuubik side table with sofa tables and shelves from the same series. Just the way that best suits your office space.

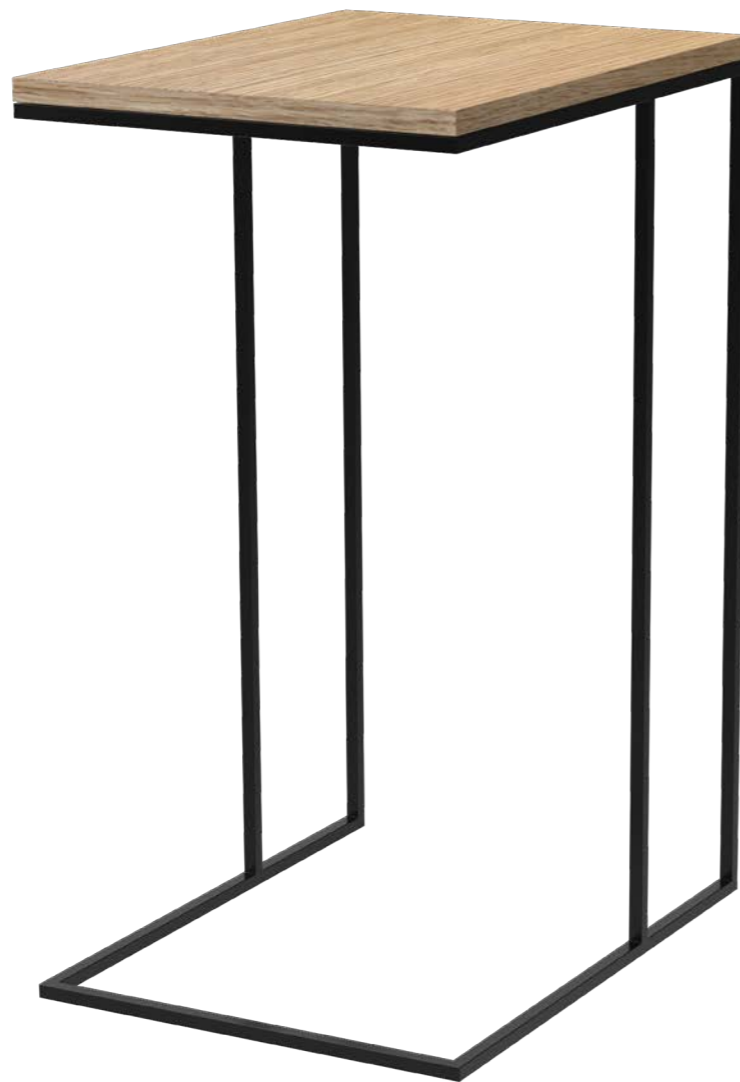

### Product information

#### Materials

##### Top board

black Valchromat mdf or oak veneer  
See pages 130-131

##### Frame

painted metal, blacks

##### Dimensions

32,5 x 42,5 x H70,6 cm

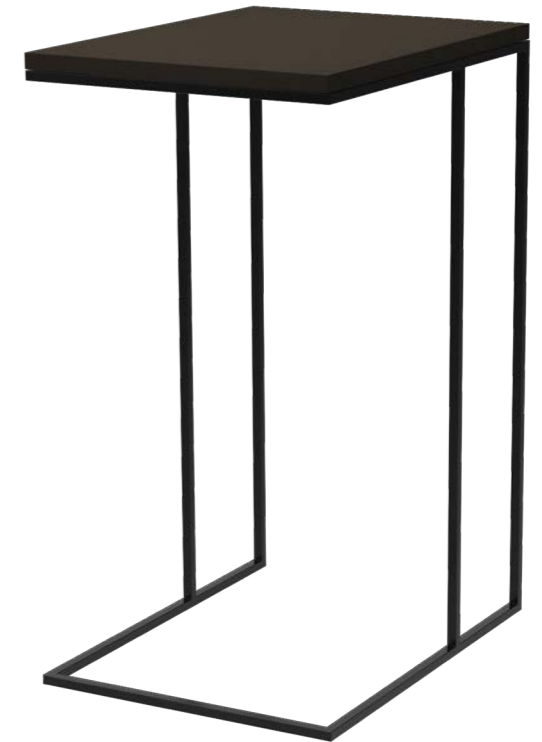

### Dimensions

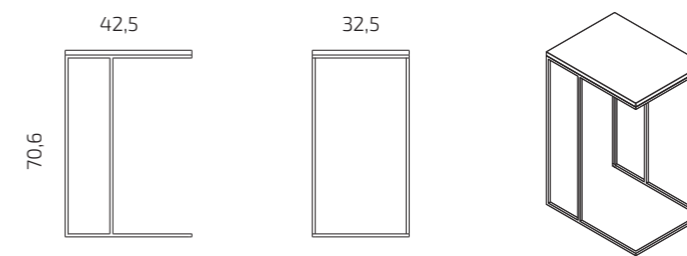

S56-TAB1

All dimensions provided in centimetres.



### Designed for the Welcome and Social Zones:

- Add comfort when working with a laptop on the couch
- Give a practical addition to the sofa



Welcome Zone



Social Zone

# Link

Bench sofa for Welcome Zone

Design: Argo Tamm



5 YEAR  
GUARANTEE



FIRE  
RESISTANT  
FABRICS



A LONG-LIFE  
PRODUCT



Welcome Zone

*Link – when you  
have only a moment  
to sit down.*

## Forever yours

Bench sofa Link is the centre of an environmentally conscious space. Its primary function is to welcome your guests, and for this, it is ready forever and ever.

Link is designed for the welcome zone, providing the ideal stopping point when you need to sit for a moment, and be ready to move on. More dignified and cosier than an ordinary bench, but also more crisp and flexible than an inviting sofa.

Worn-out parts can be easily repaired, extending the life of your Link to the end of time. But if you still want to send it to its final resting place, Link's natural materials and cleverly combined parts are 100% recyclable.

## Suitable for a Welcome Zone because it:

- is designed specifically for short sitting breaks
- lasts for years and is repairable
- complies with the principles of the circular economy

## Product information

### Frame

Plywood and sheet metal

### Cushioning

Recycled LIMI foam rubber

### Legs

Powder-coated metal legs, black RAL 7004

### Recommended cover material

Natural wool felt and easy-to-clean laminated fabrics

### Additional information

Cover material is easily removable and replaceable



*Construction of Link is  
simple and all parts are  
easily interchangeable.*



## Example combinations

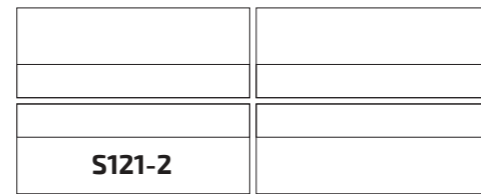
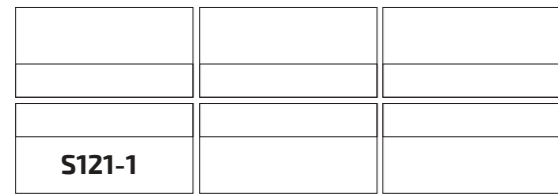
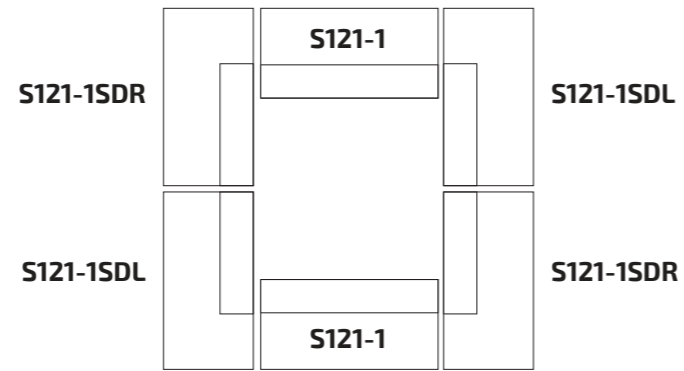
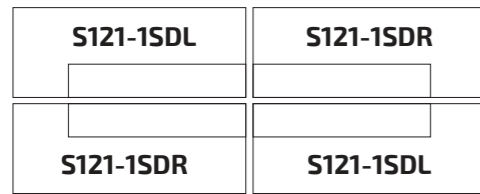

## Dimensions

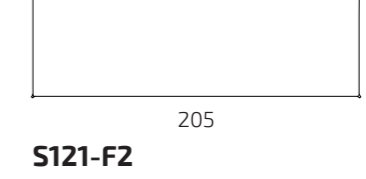
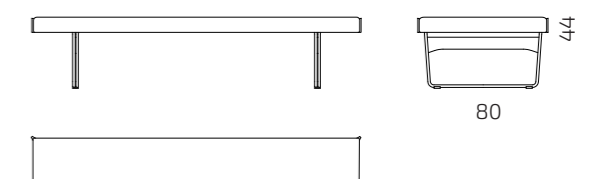
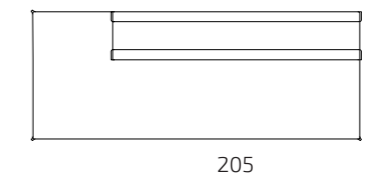
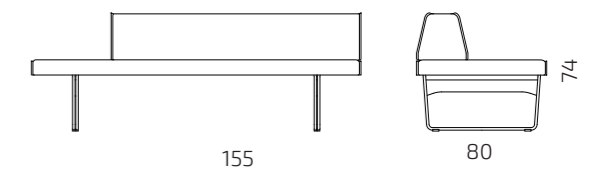
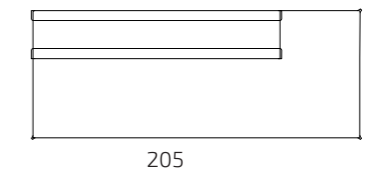
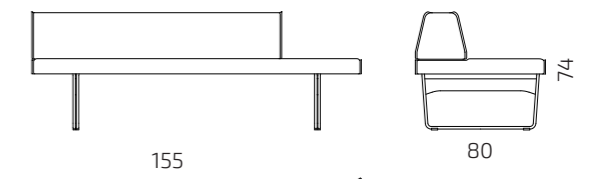
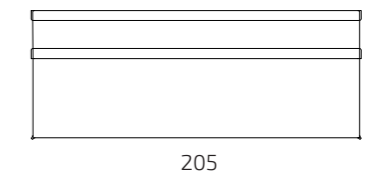
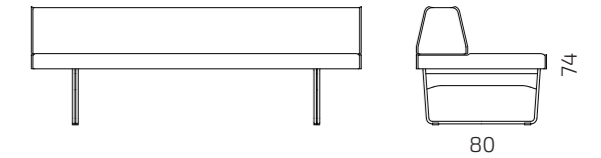
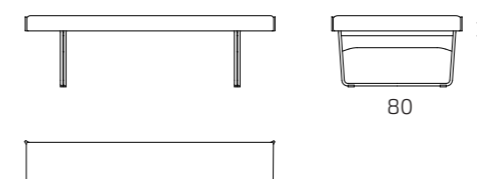
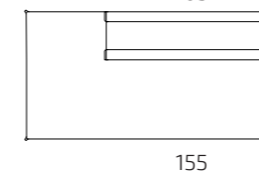
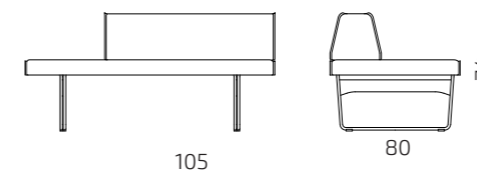
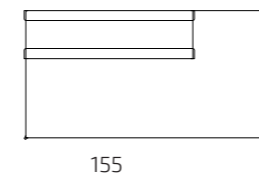
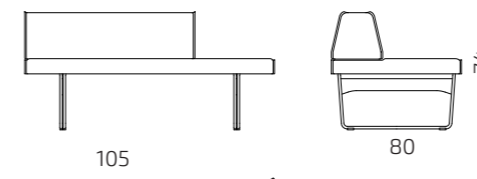
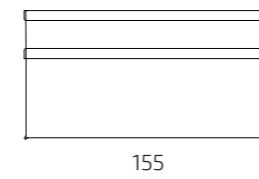
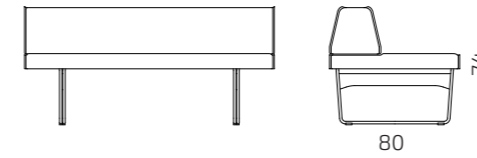

All dimensions provided in centimetres.

# Manhattan Hexa

Multifunctional hexagonal seating system

**Design:** Morten Nikolajsen

## Make a lasting impression

Leave boring reception areas behind with the endlessly adaptable Manhattan Hexa seating system. The playful hexagon modules invite conversation, inspire new ideas, and let visitors know that you're no ordinary office.

*Turn the sofa rules upside down.*

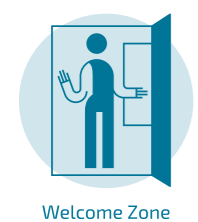

-   
**MANY DIFFERENT SIZES**
-   
**MANY COMBINATIONS**
-   
**CERTIFIED WOOD ONLY**
-   
**5 YEAR GUARANTEE**
-   
**FIRE RESISTANT FABRICS**
-   
**FIRE RESISTANT FOAM**
- AVAILABLE AT**  

## Designed for the Welcome and Social Zones:

- Make your visitors feel at home
- Create a fun waiting spot

## Product information

### Plug-in option

See pages 138-139

### Frame

Solid wood and plywood

### Upholstery

Seats and backrest have durable and fireproof HR foam

### Legs

Adjustable legs with plastic covers

### Modularity

Modules can be connected together

### Additional Information

The cover fabric is not removable; wide range of cover materials, including flame-retardant textiles

### Standard Fabric Collection

See pages 134-137



*Create a waiting area with a difference, and stand out from the crowd with a dose of the modern from Intuit.*





## Dimensions

Seat depth: 57 cm

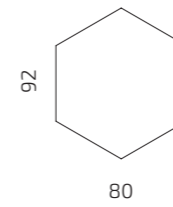
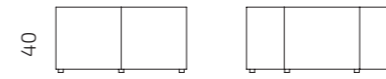

**1-F**

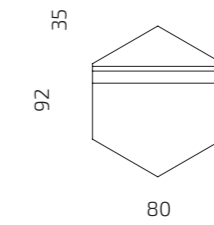
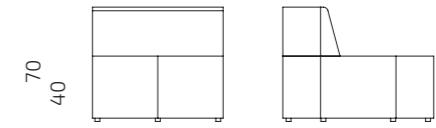

**1-S**

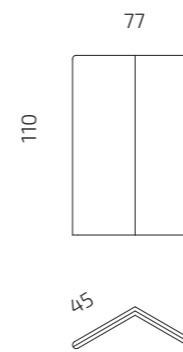

**W/ H1**

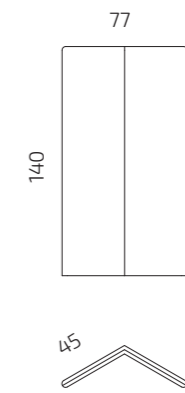

**W/ H2**

All dimensions provided in centimetres.

# Manhattan Penta

Multifunctional pentagonal seating system

**Design:** Morten Nikolajsen

## Invite them in

Reach for Penta when you need a playful flowing space for your office.

Without sacrificing comfort, the versatile modules help you create interesting shapes and welcoming spaces. Give your guests something to talk about from the moment they arrive.

*Make a splash with Penta.*



MANY  
COMBINA-  
TIONS



FSC  
CERTIFIED  
WOOD  
ONLY



5 YEAR  
GUARANTEE



FIRE  
RESISTANT  
FABRICS



FIRE  
RESISTANT  
FOAM

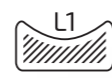

L1  
STRENGTH,  
DURABILITY AND  
SAFETY TEST

AVAILABLE  
AT  
**pCon**  
PLANNER



*The multifunctional tumble system calls out for inspiring conversations, and friendly catch-ups over coffee.*

## Product information

### Plug-in option

See pages 138-139

### Frame

Solid wood and plywood

### Upholstery

Seats and backrest have durable and fireproof HR foam

### Legs

Adjustable legs with plastic covers; metal socket option

### Modularity

Modules can be connected together

### Additional Information

The cover fabric is not removable; wide range of cover materials, including flame-retardant textiles

### Tabletop

Matte, fingerprint-resistant, high-pressure laminate Formica Infiniti™; colour options: black, white

### Standard Fabric Collection

See pages 134-137



Welcome Zone



Social Zone

## Designed for the Welcome Zone:

- Make your guests feel at home
- Create a fun waiting spot



AVIS/Budget car rental  
Tallinn, Estonia





Example combinations

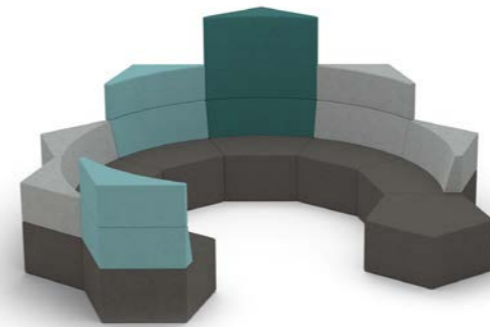
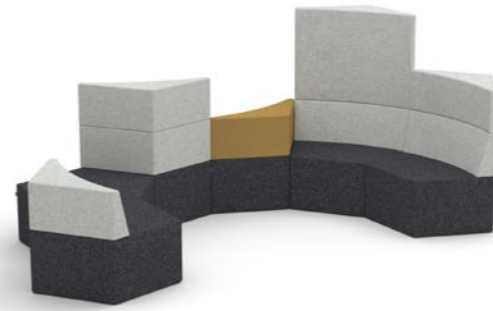

# Dimensions

Seat depth: 50 cm  
(modules 1-S/ST and 1-F/ST: 44 cm)

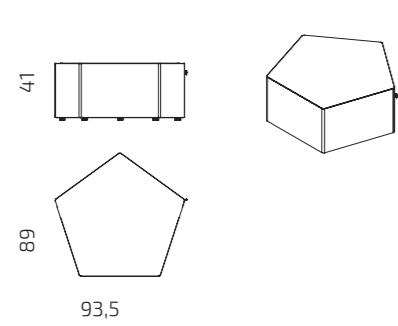

**1-F**

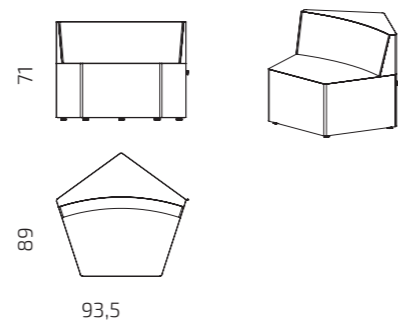

**1-S/H1**

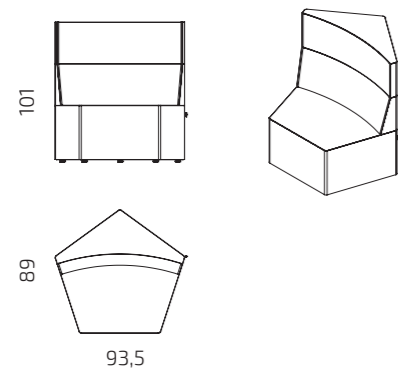

**1-S/H2**

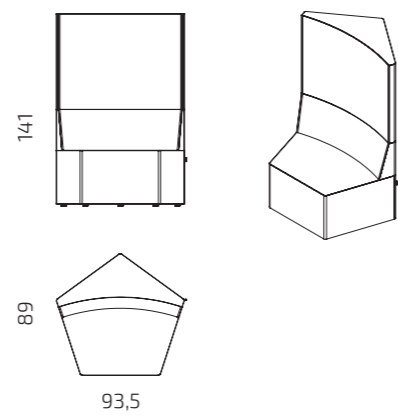

**1-S/H3**

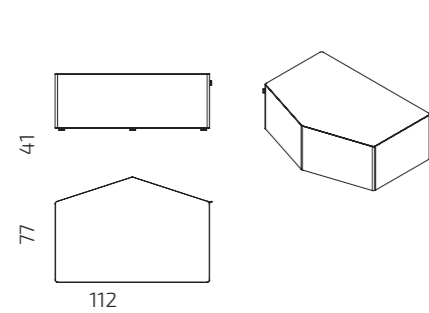

**1-F/ST**

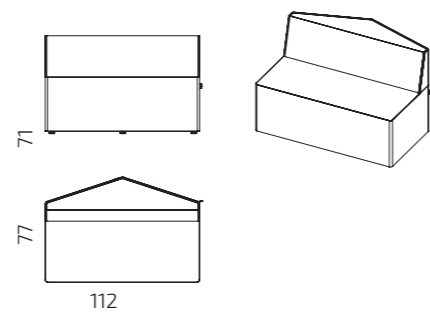

**1-S/ST**

## Tables

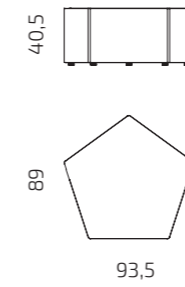

**T2**

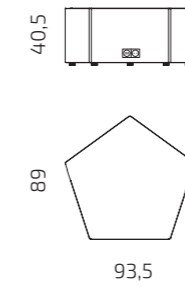

**T2/E**

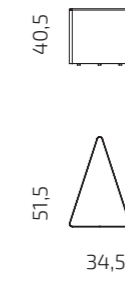

**T1**

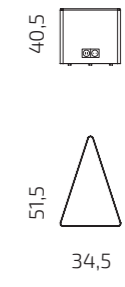

**T1/E**

## Accessories

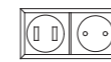

**E**

## Protective metal sockets

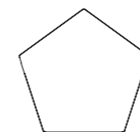

**SOC**

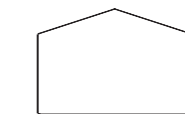

**SOC/ST**



**SOC/T1**

All dimensions provided in centimetres.

Socket height 6 cm.  
Min. order 10 pcs.

# Meeter

## Sofa modules

Design: Argo Tamm

Meeter solutions are ideal for team and individual work.

MANY DIFFERENT SIZES  
 MANY COMBINATIONS  
 CERTIFIED WOOD ONLY  
 5 YEAR GUARANTEE  
 FIRE RESISTANT FABRICS  
 FIRE RESISTANT FOAM  
 STRENGTH, DURABILITY AND SAFETY TEST  
 AVAILABLE AT



### Don't let your chairs distract from your chat

You can use the effortless design of the Meeter sofa modules wherever you want to bring people together. While its higher walls make it the perfect way to keep things focused.

Create spaces for building community while keeping your lines clean. Or contribute to a simple and modern reception area.

Shallow seating makes the Meeter perfect for tighter spots.

## Product information

Applies to all Meeter series products

### Plug-in option

See pages 138-139

### Frame

Solid wood and plywood

### Upholstery

Seats and backrest have durable and fireproof HR foam; seat cushions and backrest pillows are fixed

### Legs

Powder-coated metal: matte black RAL 9005; anti-slip soles (optional)  
 Socket option, wooden legs.  
 See pages 130-131

### Modularity

Modules can be connected together

### Additional Information

The cover fabric is not removable; wide range of cover materials, including flame-retardant textiles; custom lengths available

### Standard Fabric Collection

See pages 134-137

### Accessories

#### Additional table T-330

**Material:** innovative Valchromat mdf, high-pressure laminate; frame: powder-coated metal  
 Table can be moved; 360° rotating laptop

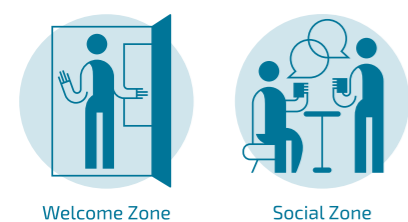

### Designed for the Welcome and Social Zones:

- Make even your smaller dining areas comfy
- Create compact waiting spots

# Dimensions

## Modular pieces

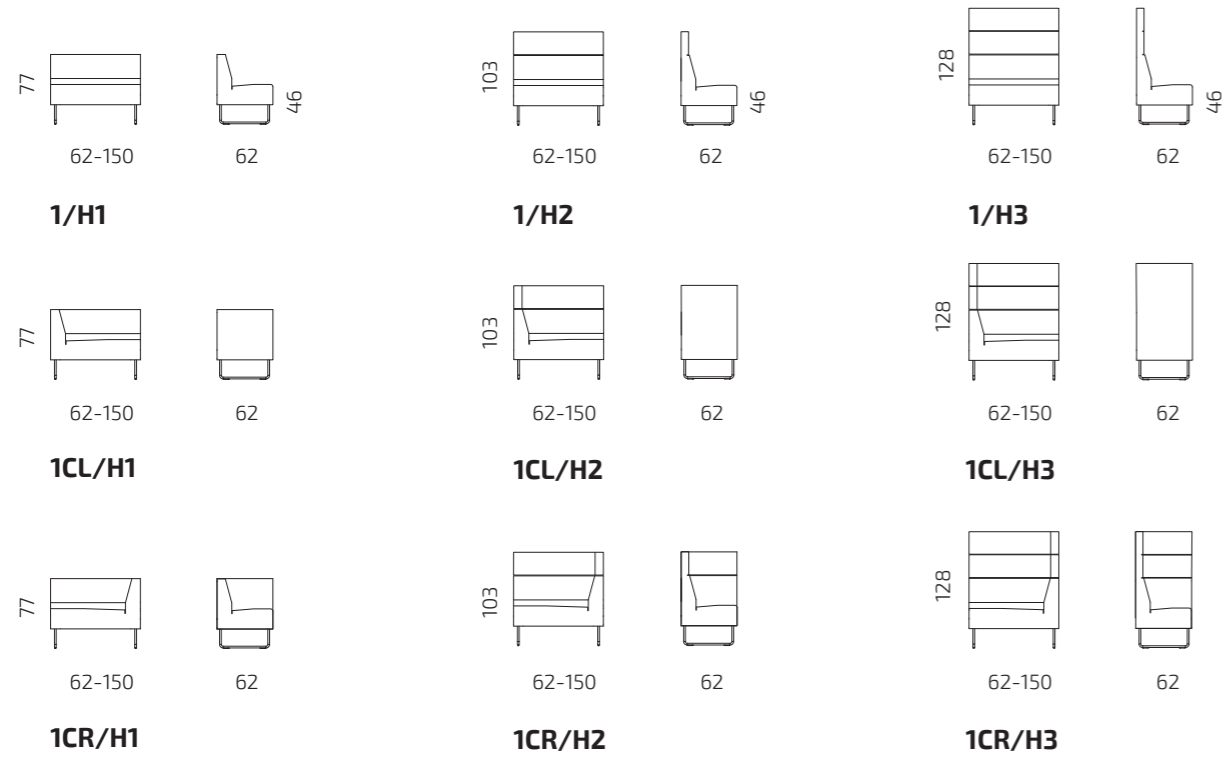

Standard lengths 62, 80, 100, 120, 150  
 Custom lengths available

Seat depth: 45 cm

## Table

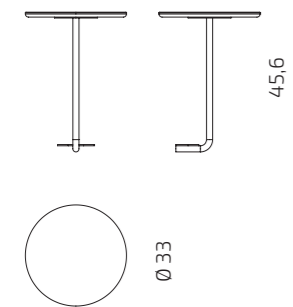

**T-330**



## Legs



All dimensions provided in centimetres.



# Meeter Chair

Dining chair

Design: Argo Tamm

NEW

*Elevating the Meeter product line, the latest addition is the Meeter chair that boasts sleek, contemporary lines, perfectly complementing its sofa counterparts.*



FSC  
CERTIFIED  
WOOD  
ONLY



5 YEAR  
GUARANTEE



FIRE  
RESISTANT  
FABRICS



FIRE  
RESISTANT  
FOAM



Welcome Zone



Social Zone

## Product information

### Frame

Plywood

### Upholstery

Seat and backrest have durable and fireproof HR foam

### Standard Fabric Collection

See pages 134-137

### Armrest

1. Black MDF covered with black laminate on top
2. Plywood with black laminate on top

### Legs

Powder-coated metal, sand structure, matte black RAL 9005; anti-slip soles (optional)

### Additional information

The cover fabric is not removable; wide range of cover materials, including flame-retardant textiles



## Dimensions

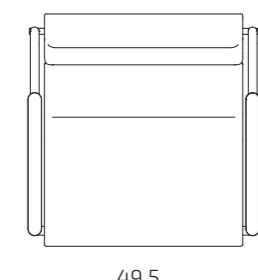
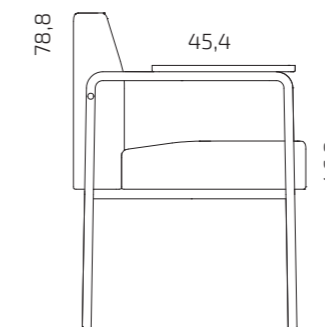
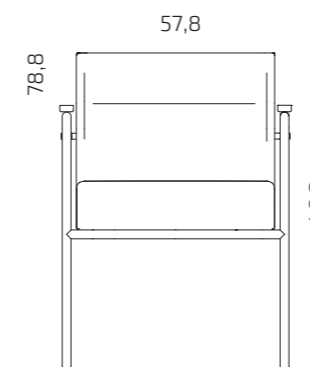

S108-ST1

All dimensions provided in centimetres.

# Meeter Round

Sofa modules

Design: Intuit design team

NEW



FSC  
CERTIFIED  
WOOD  
ONLY

5 YEAR  
GUARANTEE

FIRE  
RESISTANT  
FABRICS

FIRE  
RESISTANT  
FOAM

AVAILABLE  
AT  
**pCon**  
PLANNER



## Dimensions

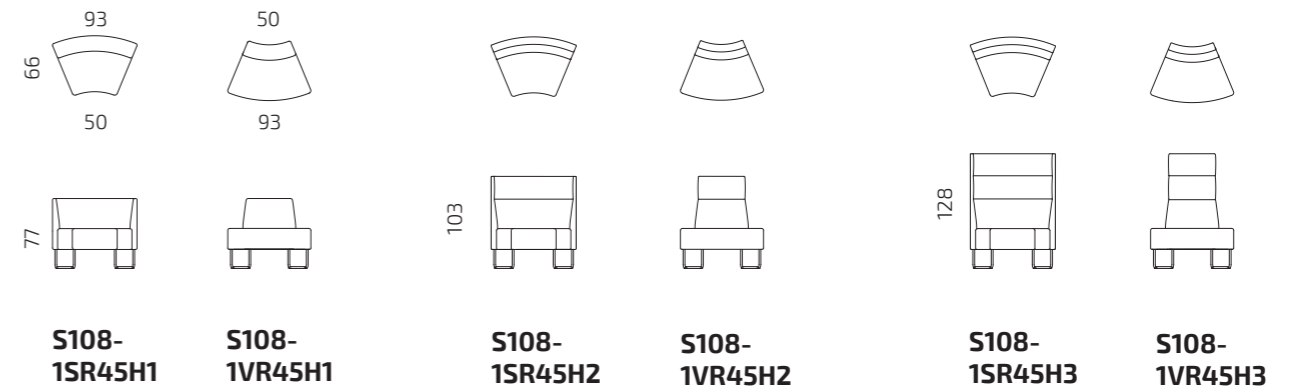

All dimensions provided in centimetres.

## Example combinations

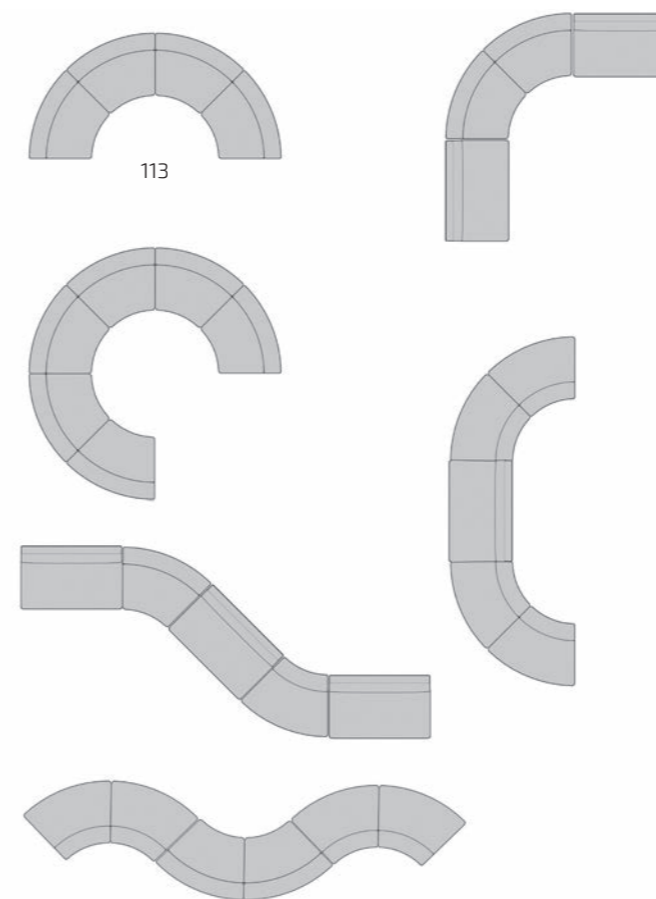

## Product information

Applies to all Meeter series products

**Plug-in option**  
See pages 138-139

**Frame**  
Solid wood and plywood

**Upholstery**  
Seats and backrest have durable and fireproof HR foam; seat cushions and backrest pillows are fixed

**Legs**  
Powder-coated metal: matte black RAL 9005; anti-slip soles (optional)  
Socket option, wooden legs.  
See pages 130-131

**Modularity**  
Modules can be connected together

**Additional Information**  
The cover fabric is not removable; wide range of cover materials, including flame-retardant textiles; custom lengths available

**Standard Fabric Collection**  
See pages 134-137

**Accessories**  
**Additional table T-330**  
**Material:** innovative Valchromat mdf, high-pressure laminate; frame: powder-coated metal  
Table can be moved; 360° rotating laptop

# Meeter Sofa

Work sofa

Design: Argo Tamm

Keep it simple  
with Meeter.



CERTIFIED  
WOOD  
ONLY



5 YEAR  
GUARANTEE



FIRE  
RESISTANT  
FABRICS



FIRE  
RESISTANT  
FOAM



STRENGTH,  
DURABILITY AND  
SAFETY TEST

AVAILABLE  
AT  
**pCon**  
PLANNER



## Dimensions

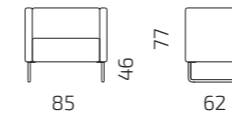

**S-1/H1**

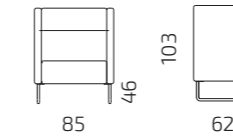

**S-1/H2**

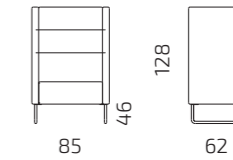

**S-1/H3**

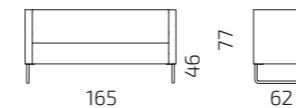

**S-2/H1**

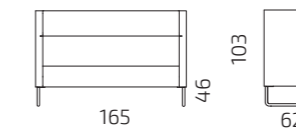

**S-2/H2**

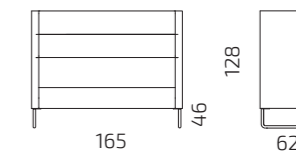

**S-2/H3**

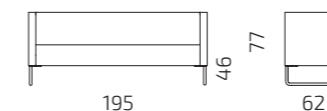

**S-3/H1**

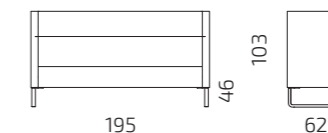

**S-3/H2**

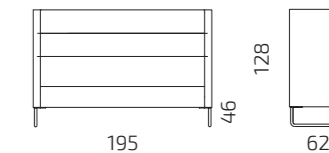

**S-3/H3**

Seat depth: 45 cm  
Seat height: 46 cm  
All dimensions provided in centimetres.

## Product information

Applies to all Meeter series products

### Plug-in option

See pages 138-139

### Frame

Solid wood and plywood

### Upholstery

Seats and backrest have durable and fireproof HR foam; seat cushions and backrest pillows are fixed

### Legs

Powder-coated metal: matte black RAL 9005; anti-slip soles (optional)  
Socket option, wooden legs.  
See pages 130-131

### Modularity

Modules can be connected together

### Additional Information

The cover fabric is not removable; wide range of cover materials, including flame-retardant textiles; custom lengths available

### Standard Fabric Collection

See pages 134-137

### Accessories

#### Additional table T-330

**Material:** innovative Valchromat mdf, high-pressure laminate; frame: powder-coated metal  
Table can be moved; 360° rotating laptop



# Meeter Workbay

## Create your own quiet oasis

The calm walls of the Meeter Workbay can contain the most important of conversations, or welcome the individual in for some deep focused work. We've all found the need for quiet and calm in the middle of a busy workplace. That's why we're helping you create the perfect Concentration Zone.

Meeter Workbay's minimalist design makes it an easy addition to any open-plan office, letting you create the private spaces you need.



CERTIFIED WOOD ONLY



5 YEAR GUARANTEE



FIRE RESISTANT FABRICS



FIRE RESISTANT FOAM



STRENGTH, DURABILITY AND SAFETY TEST

AVAILABLE AT  
**pCon**  
PLANNER



Concentration Zone

## Designed for the Concentration Zone:

- Give the option of focus and seclusion
- Hold your own private meeting
- Divide your space organically
- Cut down on background noise

## Dimensions

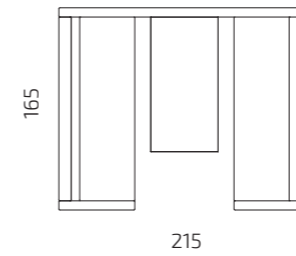
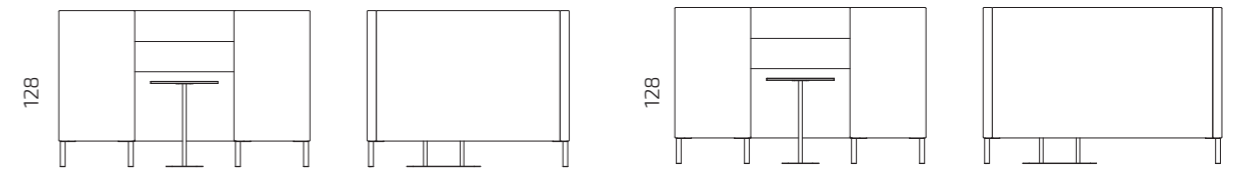

**S108-WS2H3**

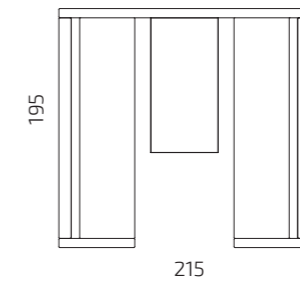
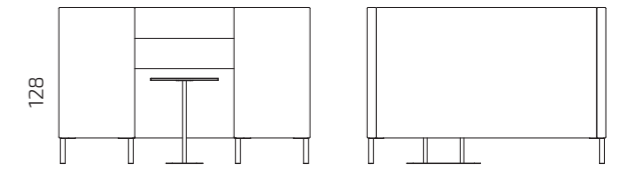
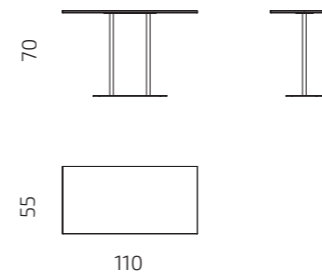

**S108-WS3H3**

All dimensions provided in centimetres.

## Product information

### Plug-in option

See pages 138-139

### Frame

Solid wood and plywood

### Upholstery

Seats and backrest have durable and fireproof HR foam; seat cushions and backrest pillows are fixed

### Legs

Powder-coated metal: matte black RAL 9005; anti-slip soles (optional) Socket option, wooden legs. See pages 130-131

### Accessories

Additional table T1/T3 Material: innovative Valchromat mdf, high-pressure laminate; frame: powder-coated metal

### Additional Information

The cover fabric is not removable; wide range of cover materials, including flame-retardant textiles; custom lengths available

### Standard Fabric Collection

See pages 134-137

*Shut the world away,  
and unlock your  
productivity.*

# Note

## Mobile whiteboard

Design: Lauri Visnapuu



5 YEAR  
GUARANTEE



FIRE  
RESISTANT  
FABRICS



GOOD SOUND-  
ABSORBING  
QUALITIES

*It's a whiteboard, but it  
will never stay white.*

### Make room for big ideas

Use our convenient mobile whiteboard to utilise every brainstorming opportunity. Equipped with 360-degree wheels, you can take the whiteboard wherever fresh ideas are born.

The back of the whiteboard is optionally covered with cutting-edge acoustic felt. Given its sound-absorbing qualities and notable height, the board can be transformed into a privacy screen, showcasing our love for multifunctional furniture.



## Product information

### Whiteboard

Polyvision ceramic steel

### Panel

MDF, upholstered with cotton batting and covered with acoustic felt on request

### Legs

Powder coated steel tube; 360° rotating and lockable wheels

### Marker holder

Varnished solid oak

### Standard Fabric Collection

See pages 134-137

## Dimensions

### Whiteboard

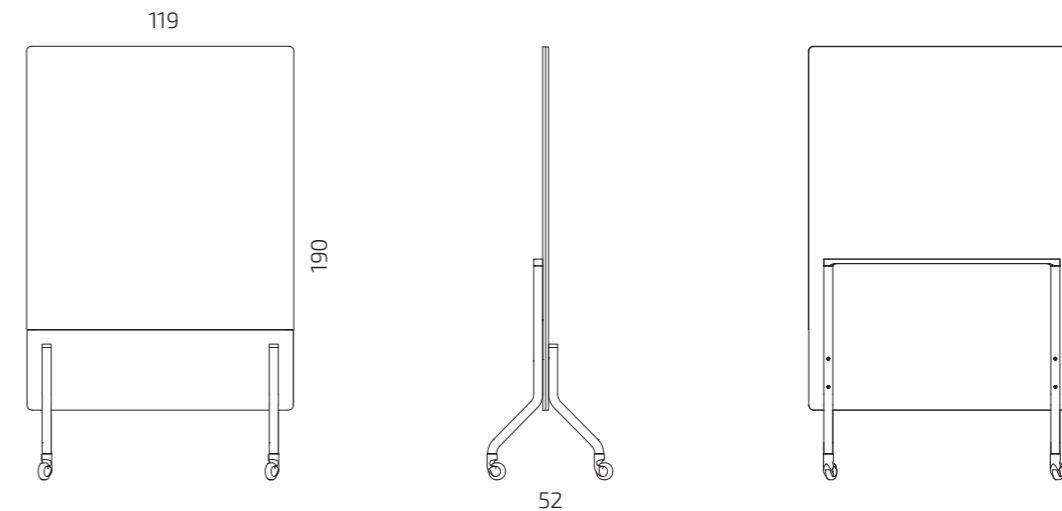

S124-MWH190

All dimensions provided in centimetres.



Collaboration Zone

### Designed for the Collaboration Zone:

- Wheel the board around for creative collaboration
- Save space with foldable screens
- Minimize workplace noise
- Divide your office on the go

# Silent Note

Portable room divider

Design: Lauri Visnapuu



5 YEAR  
GUARANTEE



FIRE  
RESISTANT  
FABRICS



GOOD SOUND-  
ABSORBING  
QUALITIES

*Be a little flexible with  
Silent Note.*

## Shape your world the way you want it

Use this mobile room divider to create a separate space in an open office exactly where you need it. Equipped with 360-degree rotating wheels, it moves easily to the work rhythm of your team.

Silent Note belongs to the Note product family and comes covered with fabric on both sides, offering unlimited possibilities for its unique design. To increase the sound absorbing properties, we recommend using an acoustic felt as a cover.

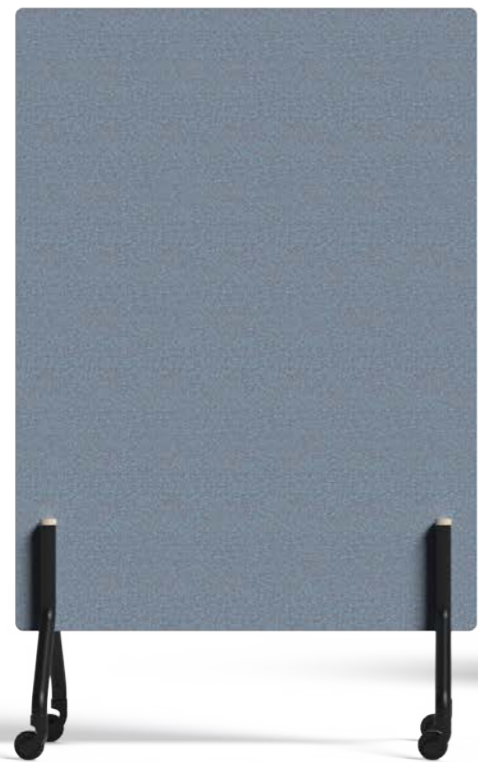

Collaboration Zone

## Designed for the Collaboration Zone:

- Wheel the room divider around for creative collaboration
- Minimize workplace noise
- Divide your office on the go

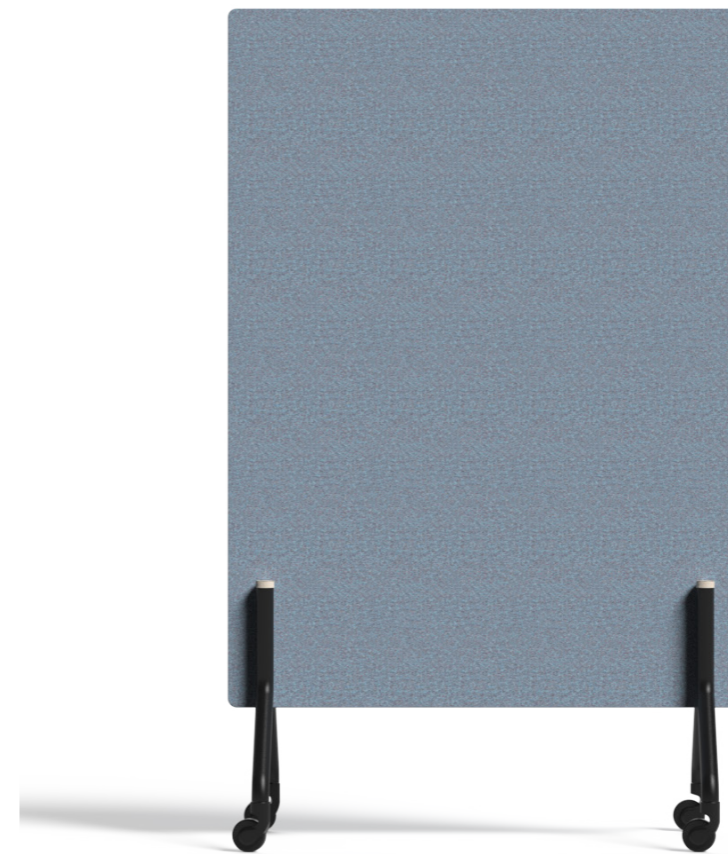

## Product information

### Panel

MDF, upholstered with cotton batting and covered with acoustic felt on request

### Legs

Powder coated steel tube; 360° rotating and lockable wheels

### Standard Fabric Collection

See pages 134-137

## Dimensions

### Room divider

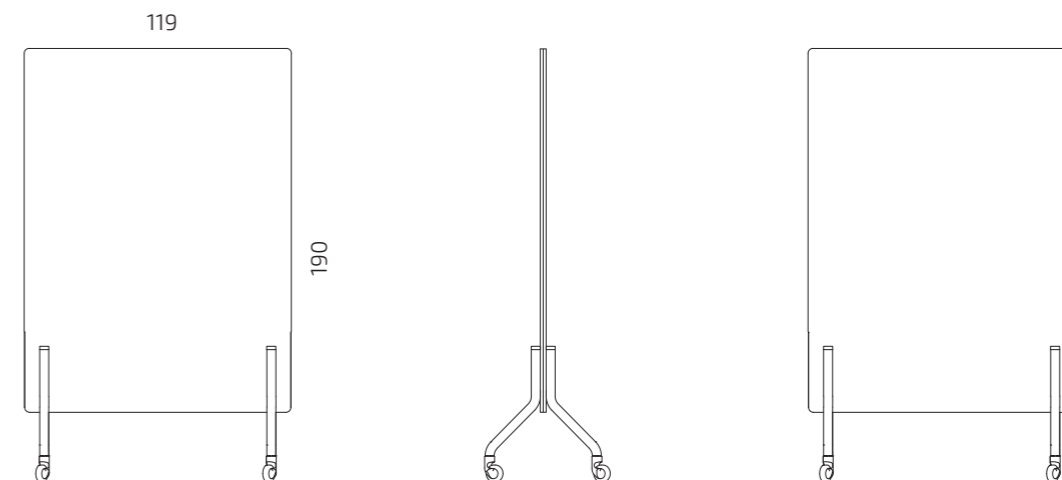

### S124-WH190

All dimensions provided in centimetres.

# Sans

## Soft work sofa

Design: Argo Tamm



MANY DIFFERENT SIZES



MANY COMBINATIONS



CERTIFIED WOOD ONLY



5 YEAR GUARANTEE



FIRE RESISTANT FABRICS



FIRE RESISTANT FOAM



STRENGTH, DURABILITY AND SAFETY TEST

AVAILABLE AT  
**pCon**  
PLANNER

*Sans - the perfect place to wait a while.*



Welcome Zone

### Designed for the Welcome Zone:

- Make your visitors feel at home
- Offer up moments of rest and relaxation
- Divide your space organically

### Sit back and relax

Designed for use in public spaces, Sans is more than just comfortable – it's so cozy you'll probably never want to get up again!

We all want to give a good first impression, and furnishing your Welcome Zone with a Sans Sofa shows visitors you mean business, and you care about people. With soft padding and a thin metal plinth, you can have comfort even in smaller spaces.

Comfortable and practical for a communal space, the Sans is available as a classic sofa, or with an integral table. Pop down your coffee cup, lean back, and enjoy the clean lines and sociable layout.

With its modular design and high walls option, Sans can also be used to increase privacy and enhance acoustics in your Concentration Zone.



## Product information

### Plug-in option

See pages 138-139

### Frame

Solid wood and plywood

### Seat & backrest

Durable and fireproof HR-foam; seat frame with springs

### Additional pillows

Feather filling; two sizes available

### Legs

Powder-coated metal, colour option: black; plastic soles. See pages 130-131

### Additional information

The cover fabric is not removable; wide range of cover materials, including flame-retardant textiles

### Accessories

Various additional tables; material: high-pressure laminate, colour option: black. See pages 108-109

### Standard Fabric Collection

See pages 134-137

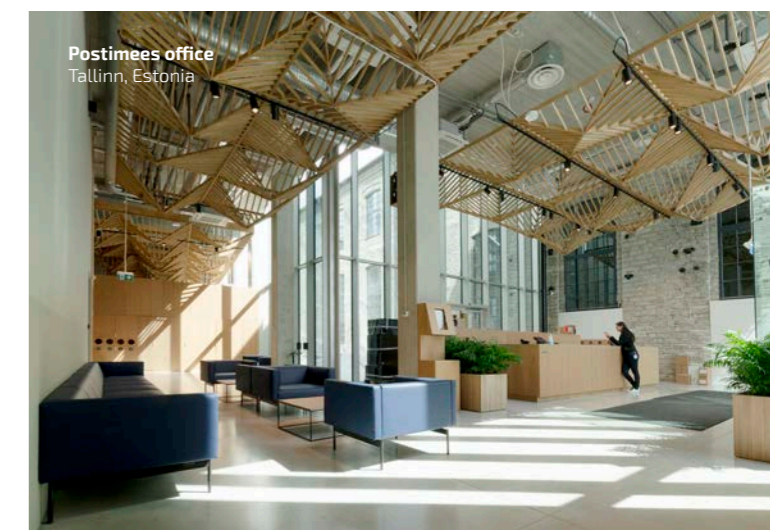





Example combinations

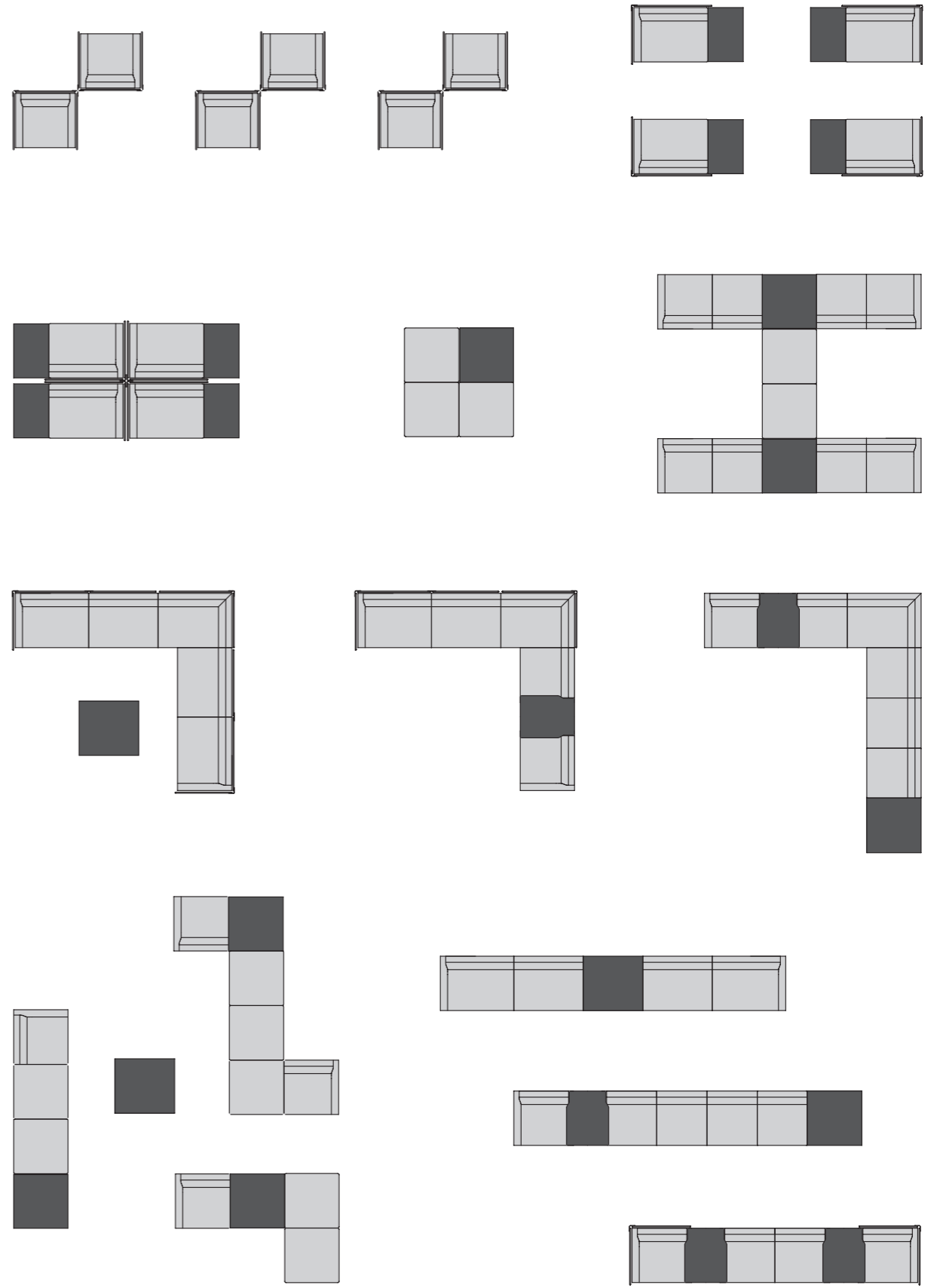

# Dimensions

## Individual modules

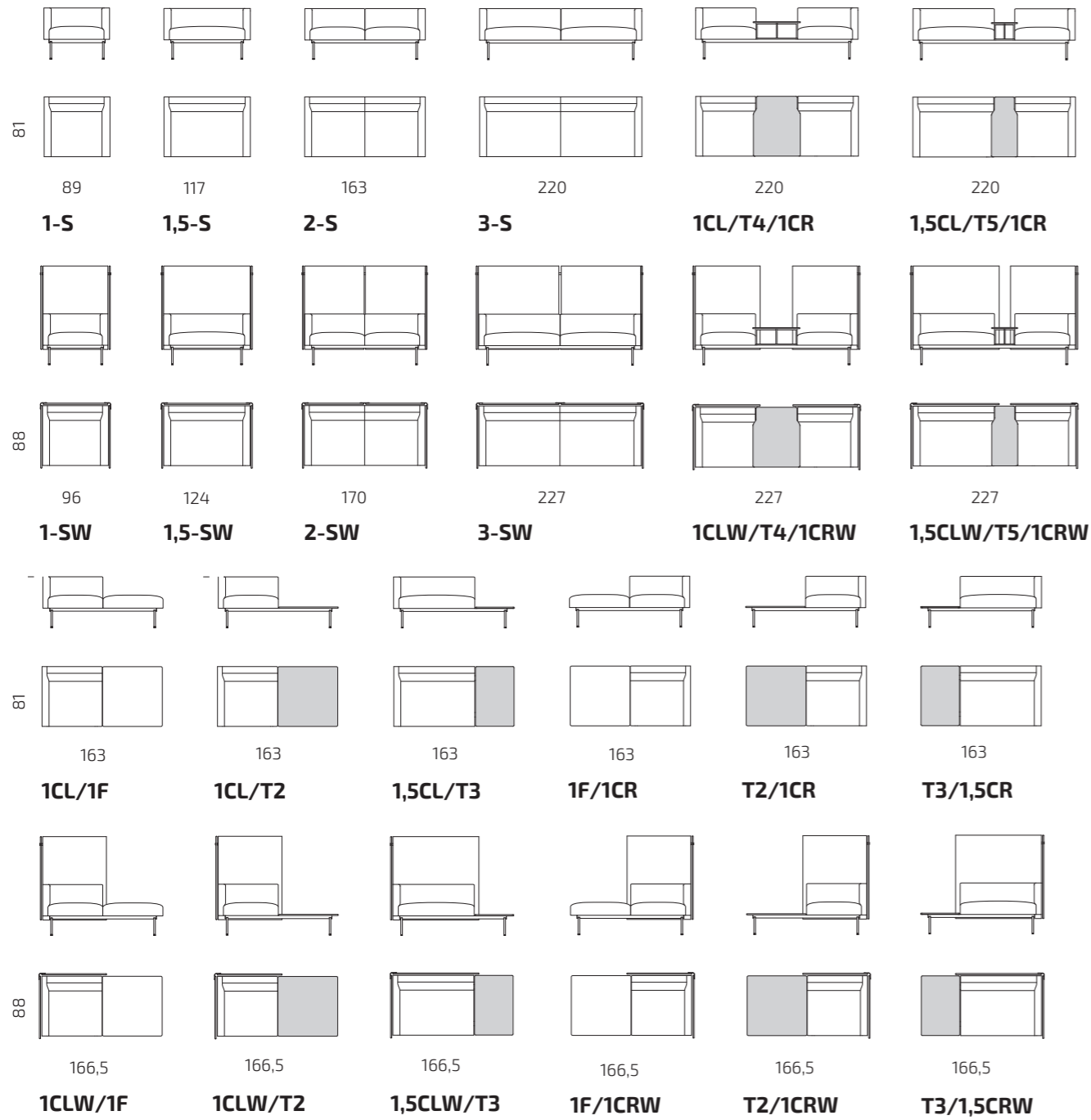
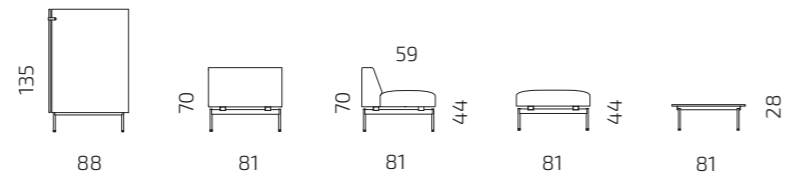

## Daybed

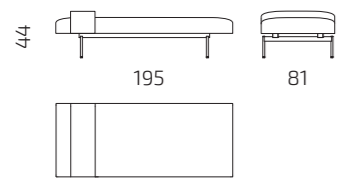

DB1

## Poufs and tables

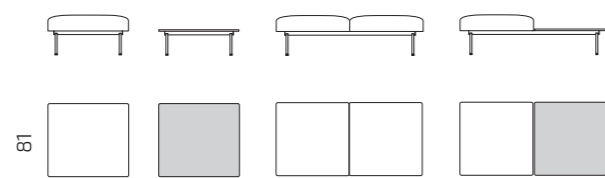

1F T1 2F 1F/T2

## Additional pillows

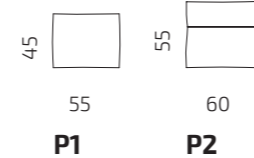

P1 P2

## Modules to combine

All dimensions provided in centimetres.

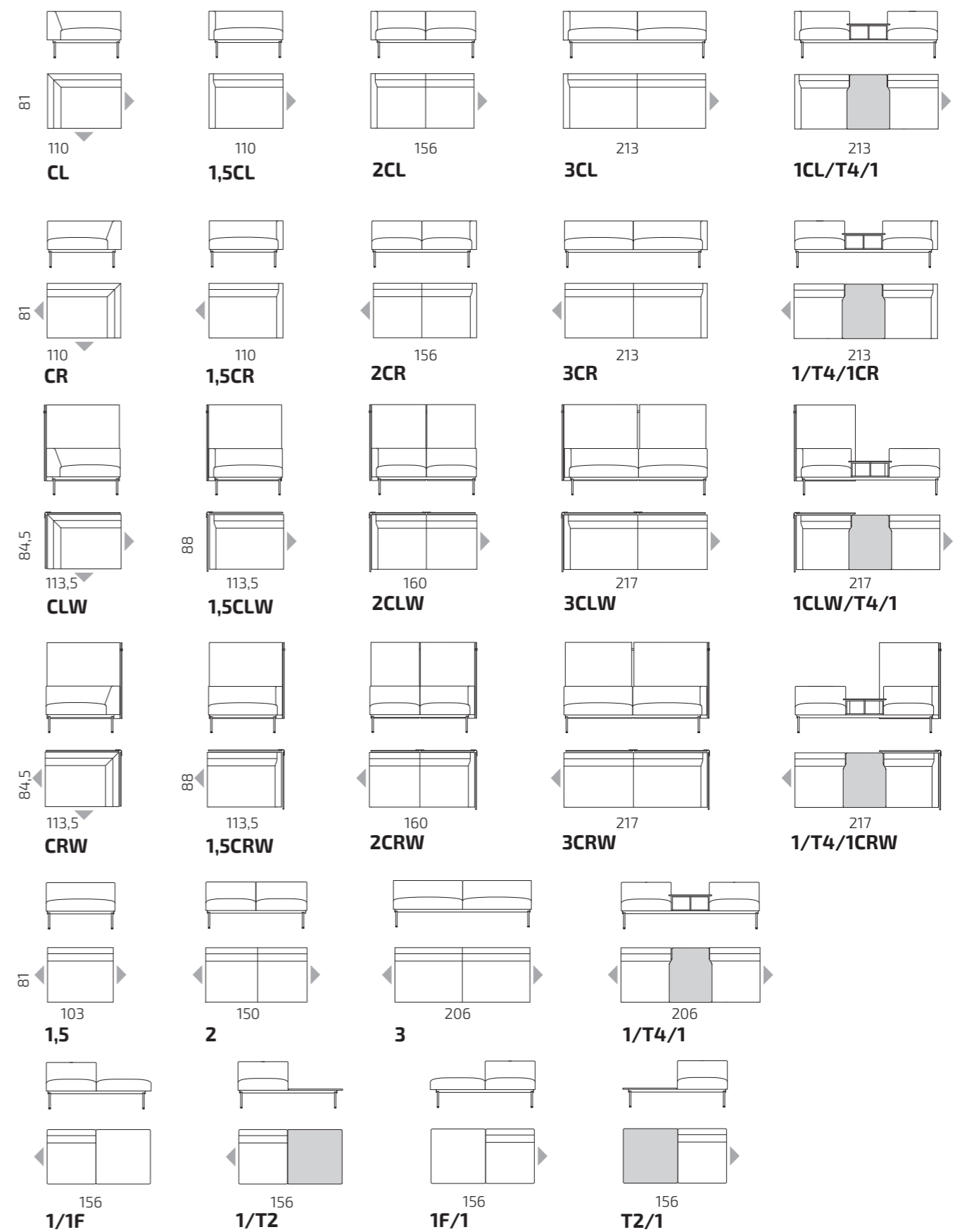





# Sofi

## Sofa & pouffe system

Design: Janno Nõu, Iseasi



CERTIFIED  
WOOD  
ONLY



FIRE  
RESISTANT  
FABRICS



FIRE  
RESISTANT  
FOAM



5 YEAR  
GUARANTEE

### Kick back and relax.

With their fresh look and slim proportions, the Sofi sofa and pouffe make even the smallest Welcome Zones inviting. Your visitors will want to put their feet up and settle in with a coffee – so comfy they won't even mind if you're a little late!



## Product information

### Frame

Solid wood and plywood

### Seat & backrest

Durable and fireproof HR-foam

### Legs

Solid wood oak

### Additional information

The cover fabric is not removable; wide range of cover materials, including flame-retardant textiles

### Standard Fabric Collection

See pages 134-137

## Example combinations



Welcome Zone

### Designed for the Welcome Zone:

- Make your guests feel at home
- Create cosy spots in even the smallest spaces
- Move around as the conversation flows

*How do you make your welcome area more welcoming? By designing something that feels like home.*



## Dimensions

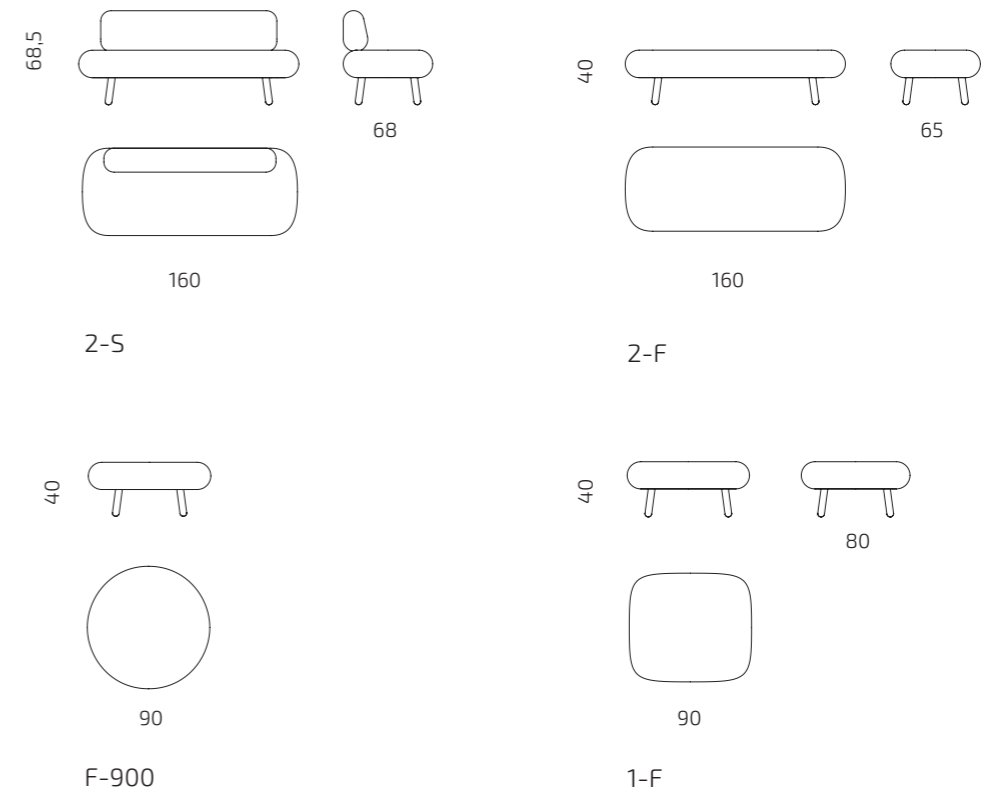

Seat depth: 48 cm  
All dimensions provided in centimetres.

# Stand-Up Creative Corner

**Design:** Iseasi

*Team interaction is the new primary purpose of the office across all generations of workers.*



Collaboration Zone



## Dynamic and flexible space for collaboration

So how do we get the creative juices flowing? Simple: design for interaction and ideation. We need dynamic and flexible space where furniture doesn't hamper us, but instead empowers our collective creativity – without us even being aware of it. Innovative environments that support working together ask for different type of settings and furniture than we're used to seeing in an office. The Creative Corner invites new ideas and new kinds of behavior into your office, and gets them working for you.

Designed for dynamic collaboration, the mobile **Rolf table** can be easily moved around in your space. Given its height, you can work at the table on your feet or by resting your weight on one of our **Hubert pouffes**. Chairs with raised seating keep your back straight and your mind sharp. They set you no barriers. Jumping up to throw yourself into the discussion is quick and easy.

*When it comes to dynamic collaboration, there's no place like the office.*

## Designed for the Collaboration Zone:

- Encourage active problem-solving
- Bring heads together at a moment's notice
- Make your office flexible

# Hubert and Hubert Mini

High and low pouffe

Design: Iseasi

**Because the best ideas are a little different.**

A chair that lets you brainstorm in style. The sleek frame and raised seat of the Hubert high pouffe help to support ergonomic posture effortlessly, while the 360° swing leg lets you swivel and rock while ideating – great for productive, dynamic team meetings. Simple to manoeuvre, these chairs help you create a welcoming and agile space at a moment's notice.



5 YEAR GUARANTEE



CERTIFIED WOOD ONLY



FIRE RESISTANT FABRICS



FIRE RESISTANT FOAM

AVAILABLE AT  
**pCon**  
PLANNER



Collaboration Zone

### Designed for the Collaboration Zone:

- Encourage active problem-solving
- Bring heads together at a moment's notice
- Make your office flexible

## Product information

### Frame

Plywood

### Upholstery

Durable and fireproof HR-foam

### Legs

Rocking base; material: oak

360° rocking base; material: plastic POM, black

### Additional information

The cover fabric is not removable.

### Standard Fabric Collection

See pages 134-137

## Dimensions

### 360° rocking & rotating base    Rocking base

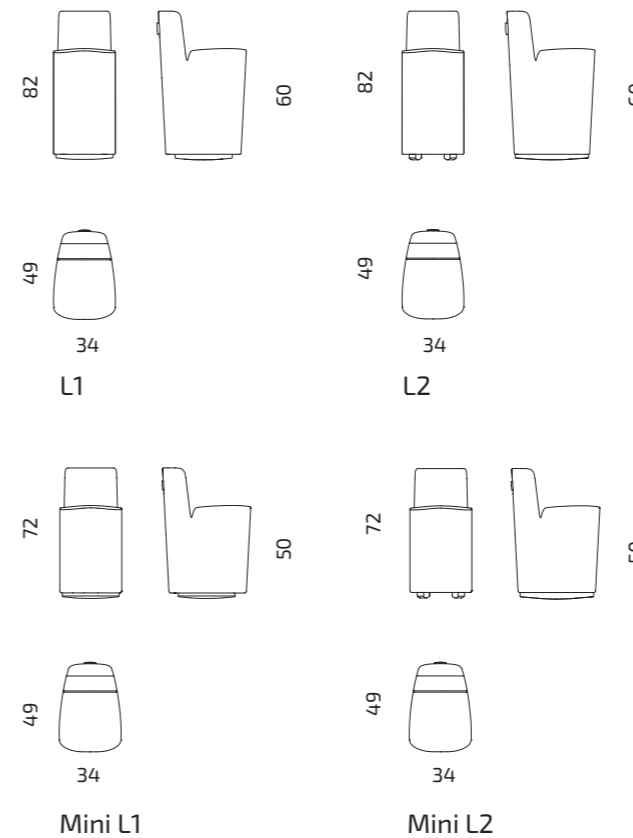

Seat depth: 36 cm  
All dimensions provided in centimetres.

The chic design also comes in miniature. Hubert Mini has all the benefits of ergonomic design, manoeuvrability, and style, whilst being just the right size for regular meeting tables.

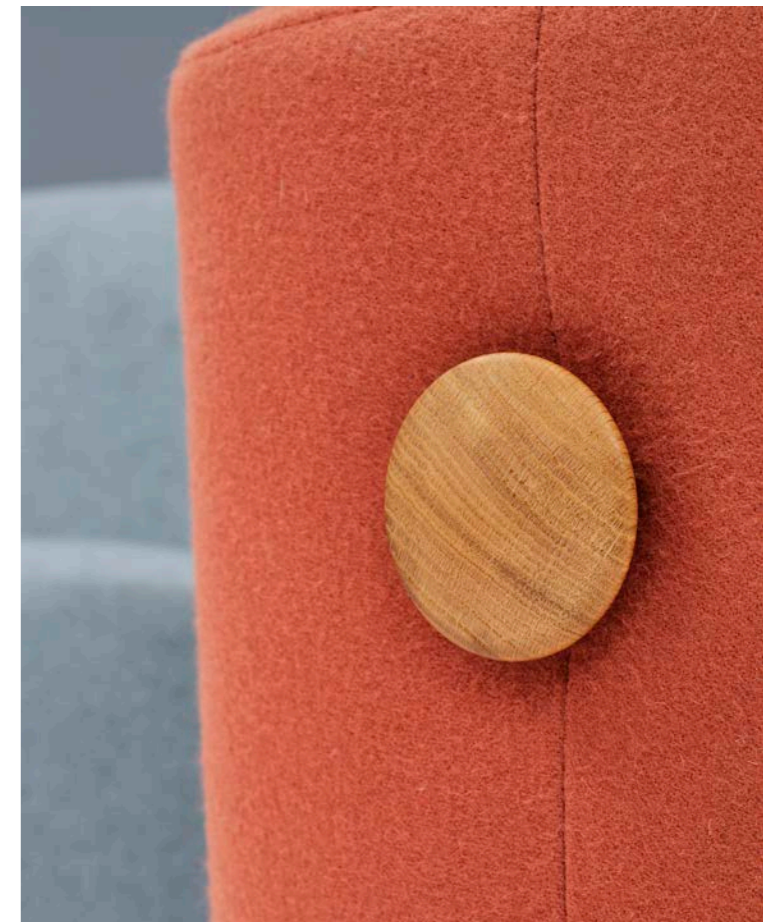

*Add some dynamics to your conversation.*



# Rolf

## Mobile table

Design: Iseasi



CERTIFIED  
WOOD  
ONLY



FIRE  
RESISTANT  
LAMINATE



5 YEAR  
GUARANTEE

AVAILABLE  
AT  
**pCon**  
PLANNER



### Keep your conversations agile

A table for flexible collaboration. Designed for ease of movement with its attached wheels and sturdy oak frame, with a height that makes stand-up meetings a breeze. Use these on their own, or push them together to create different configurations. Bar stool height, and always ready for when inspiration strikes, pull over the Rolf and get collaborating.



### Dimensions

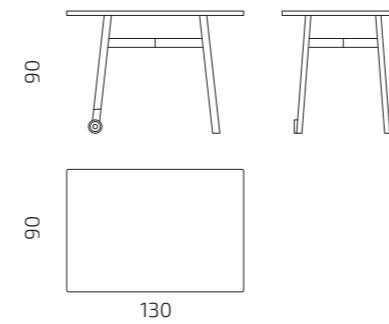

ROLF-130

### Product information

#### Tabletop

Matte, fingerprint-resistant, high-pressure laminate Formica Infiniti™; oak edging. See pages 130-131

#### Legs

Varnished oak; wheels

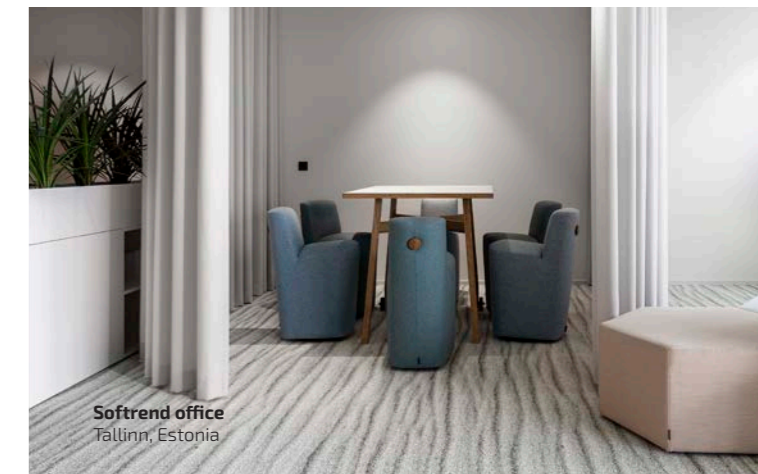

Softrend office  
Tallinn, Estonia



Collaboration Zone

### Designed for the Collaboration Zone:

- Encourage active problem-solving
- Bring heads together at a moment's notice
- Make your office flexible

# Pouffes Loop, Duo and Twin

Pouffes

Design: Lauri Visnapuu

NEW

Hop on the ideas train with Loop, Duo & Twin.



-   
FSC  
CERTIFIED  
WOOD  
ONLY
-   
FIRE  
RESISTANT  
FABRICS
-   
FIRE  
RESISTANT  
FOAM
-   
5 YEAR  
GUARANTEE

## Designed for the Collaboration and Social Zones:

- Make your seating super flexible
- Gather wherever you need to
- Bring some playful energy



Collaboration Zone



Social Zone

## Grab the opportunity

We think you should be able to gather wherever inspiration strikes. Which is why we've designed our trio of playful pouffes to be the ultimate in flexible seating.

Grab them by their tabs and pull them over to your colleague's desk. So that you can carry on forming your new idea, without getting a crick in your neck.

## Product information

### Frame

Solid wood and plywood

### Upholstery

Durable and fireproof HR foam

### Additional information

The cover fabric is not removable

### Standard Fabric Collection

See pages 134-137



## Dimensions

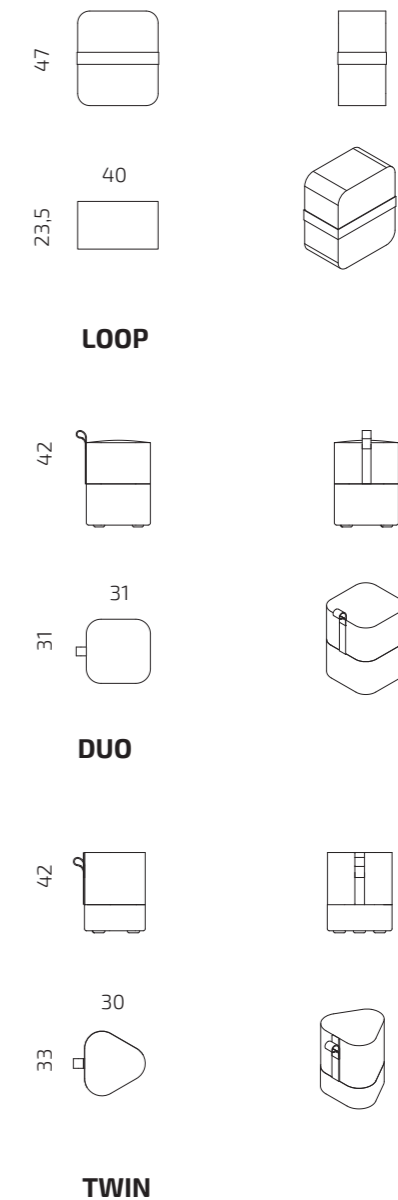

All dimensions provided in centimetres.

# Sigmund

## Sound-absorbing screen

**Design:** Pent Talvet, Iseasi

  
GOOD SOUND-  
ABSORBING  
QUALITIES

  
FSC  
CERTIFIED  
WOOD  
ONLY

  
FIRE  
RESISTANT  
FABRICS

  
FIRE  
RESISTANT  
FOAM

  
5 YEAR  
GUARANTEE

AVAILABLE  
AT  



### Shape your world the way you want it

The office of the future is agile and flexible. When you need to change the use of a space without knocking down walls, then you need Sigmund. This ingenious sound-absorbing screen can make any area feel like a private office.

Create a smaller Collaboration Zone within an open-plan space, or curate an enclosed seating area. Wherever the flow of your workplace, Sigmund can help you intuitively meet the needs of your team. Without having to don a hard hat.

### Product information

#### Filling

Synthetic felt with sound-absorbing qualities; cotton batting; HR-foam

#### Legs

360° rotating wheels

#### Additional information

The cover fabric is not removable; wide range of cover materials, including flame-retardant textiles

#### Standard Fabric Collection

See pages 134-137

*Be a little flexible with Sigmund. This soundabsorbing screen enables you to easily create zones in an office.*



### Dimensions

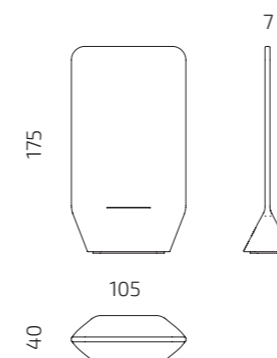

**W/H-175**

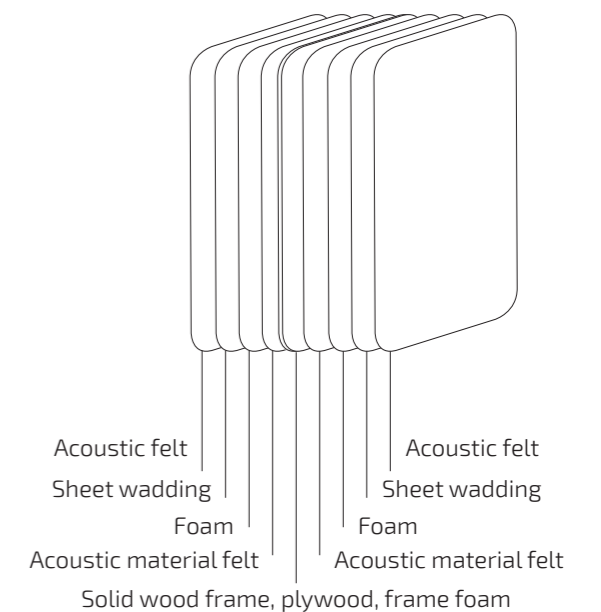

Collaboration Zone



Social Zone

### Designed for the Collaboration Zone:

- Divide your open space
- Deal with background noise
- Create a quiet corner
- Easily display information



# Spot

## Multifunctional seating furniture

Design: Pent Talvet, Iseasi

NEW



FIRE  
RESISTANT  
FABRICS



FIRE  
RESISTANT  
FOAM



CERTIFIED  
WOOD  
ONLY



5 YEAR  
GUARANTEE

### Just the place to be

Spot is a centre of attraction, one that dominates both the Welcome and Social zones. The four modules can be used to create varied solutions for one or more seated individuals. Whether Spot offers privacy to the person who is waiting or facilitates communication is purely a question of placement.

Always practical, Spot is a combination of an inviting seating area and a useful supporting surface. The shelves surrounding the seat form ideal supports on which to place a computer or simply to lean against. The shelves feature recessed sockets, enabling Spot to serve as a workspace, if desired. In addition to books and houseplants, the shelves confidently support various furnishing elements that enliven the office space. Spot also makes it easy to divide rooms into zones.

Attracts people  
and things.



Welcome Zone



Social Zone

### Suitable for the Welcome and Social zones because it:

- is a comfortable place to wait;
- can serve several functions;
- helps to create an inviting atmosphere.

## Product information

### Frame

Plywood

### Upholstery

Seats and backrest have durable and fireproof HR foam and batting; seat cushions and backrest pillows are fixed

### Standard Fabric Collection

Structured fabrics recommended  
See pages 134-137

### Shelving

Pine plywood with pine veneer back board, clear matte varnish; top board Forbo desktop linoleum Nero

### Table

Forbo desktop linoleum Nero

### Legs

Powder-coated metal, sand structure, matte black RAL 9005; anti-slip soles (optional)

### Modularity

Modules can be connected together

### Additional information

The cover fabric is not removable

### Plug in options (optional)

Electric outlet: Powerdot Mini 50 1x type F-type socket; Powerdot Mini 52 2x USB-C; Powerdot Mini 51 2x USB-A



## Dimensions

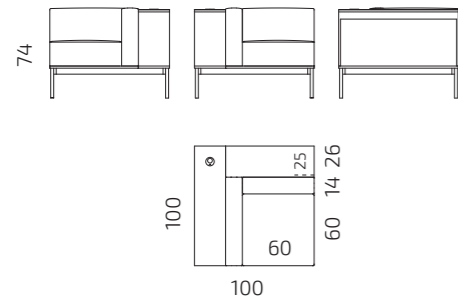

Module A left handed configuration  
**S126-1CLA**

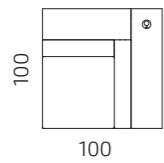

Module A right handed configuration  
**S126-1CRA**

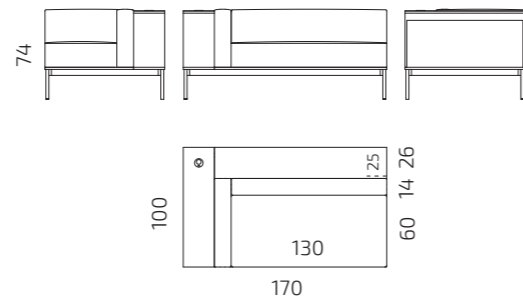

Module B left handed configuration  
**S126-2CLB**

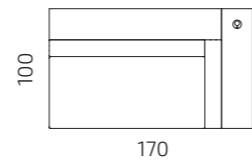

Module B right handed configuration  
**S126-2CRB**

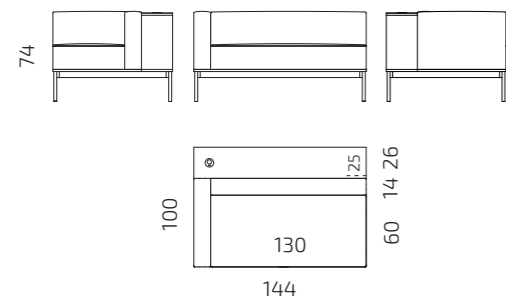

Module C left handed configuration  
**S126-2CLC**

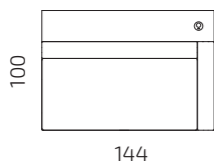

Module C right handed configuration  
**S126-2CRC**

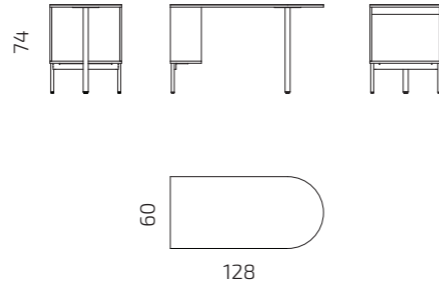

Module L - Table  
**S126-T1**

All dimensions provided in centimetres.

## Modules



**Module A**



**Module B**



**Module C**



**Module L**

## Combinations



# Cover materials

## Valchromat® colour options for additional table

Applicable: August, Frankie, Kuubik, Meeter

### Standard colour selection:

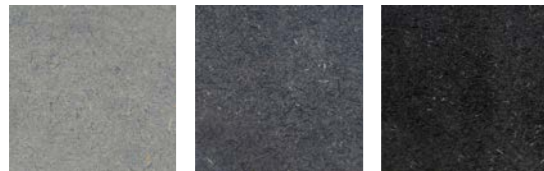

Light grey    Grey    Black

### Custom colour options for Kuubik:

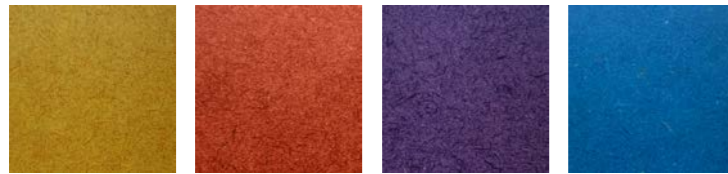

Yellow    Red    Purple    Blue

Valchromat® is an innovative wooden board that combines the natural properties of wood with bright colours. Because Valchromat is about 30% more dense than usual MDF boards and is coloured throughout, it is also more resistant to mechanical damage.

In the Valchromat production process, painted wood particles are glued together with a special low-formaldehyde resin with good lubricity. Small wood particles create a delicate sparkling pattern on the board, so differences in colour and pattern may sometimes occur.

- Custom colour at customer's request from Valchromat colour catalogue
- Additional optional cost will be added
- Custom colour is not stock material, extra delivery time 2-3 weeks



Ecological organic dyes. Formaldehyde emissions are within the limits set by European standards.

## Colour options for metal frame

Applicable: Alfred, August, Frankie, Kuubik, Meeter, Penta, Sans

### Standard colour options:



White RAL 9016    Grey RAL 7030    Graphite RAL 7022    Black RAL 9005

### Custom colour options for Kuubik:



Yellow RAL 1032    Red RAL 3016    Purple RAL 4007    Blue RAL 5009

- Custom colour choice at customer's request from RAL catalogue
- Custom colour is not stock material, it is necessary to specify the minimum quantity, extra delivery time 2-3 weeks

## Solid wood finishing options for legs and leg frames

Applicable: Alfred, August, Intro, Meeter, Rolf, Sofi



Whitened    Natural    Dark    Wenge    Black

## High-pressure Laminate

Applicable: August, Frankie, Meeter, Penta, Sans, Rolf

Custom colour is not stock material, it is necessary to specify the minimum quantity, extra delivery time 2-3 weeks

### Formica Infiniti™

Matte, fingerprint-resistant, high-pressure laminate.

As beautiful as it is durable, Formica Infiniti® Laminate features a soft-to-the-touch super matte finish, resists fingerprints, has thermal healing capabilities and built-in antimicrobial surface protection.

**Abet Polaris** is smooth and velvety to the touch, and its surface features are truly extraordinary: it is highly resistant to scratches and heat, as well as being anti-fingerprint.

The curious combination of durability and velvet smoothness gives Polaris a futuristic appeal, making it the ideal choice for ultra contemporary projects, delighting the senses with a pleasant and unique effect.

### Standard Colors

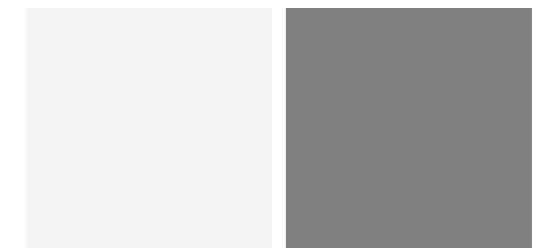

White Formica Infiniti™ F949 White    Gray Abet Polaris 2907 Gris Foncé Pol

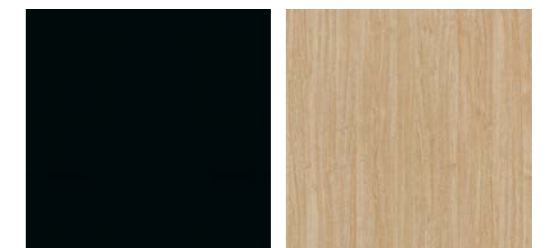

Black Abet Polaris 2902 Noir Pol    Bio-Oak F7603



# Fabric collection

*Our standard selection includes contract fabrics from different suppliers: Camira, Kvadrat, Gabriel, Nevotex, Agua*



## Sustainable fabrics

Caring about the world around us we make long-lasting furniture and use fabric leftovers on specially designed products. To minimize our impact on nature even further we have also included several environmental-friendly and recycled fabrics to our standard selection.

Camira's Rivet is designed to blend the aesthetic qualities of luxury woolen apparel with modern performance sportswear, Rivet is a lightly textured hopsack which emulates the swathe of suiting in a well-heeled synthetic. Rivet is made from 100% REPREEVE®, a brand of recycled polyester made from used plastic bottles.

Gabriel's Cura is a multi-purpose, two-coloured upholstery fabric made from 98% post-consumer recycled polyester. It fuses modern performance with a warm, casual aesthetics and a soft, voluminous touch.

Blue Company's Dama is an eco-friendly fabric made of recycled wool, suitable for multipurpose use. Wool has very good acoustic qualities - it increases sound-absorbing and that makes it especially good choice to use on our products in open-plan offices.



## Easy-clean fabrics

Aquaclean® technology is a revolutionary fabric treatment that allows you to clean stains using water only. This provides you with simple fabric maintenance in the minimum amount of time.

Aquaclean helps to remove the majority of household stains (wine, ink, sauce, fat, mud, chocolate, cream, etc.) making life easier and giving you more time for the more important things.













# Standard Fabrics Selection 2023

## Price category 1

Brand	Design	Martindale	Composition	Flammability standard			Sustainability	Other
				EN 1021 1 & 2	BS 5852 Part 1 0 & 1	BS 5852 Part 2 5 CRIB		
Camira	<b>Era CSE:</b> 01, 02, 21, 25, 31, 32, 34, 39, 41, 42	100 000	100% polyester	X		X	OEKO-TEX® CONFIDENCE IN TEXTILES STANDARD 100	10 YEAR
Fargotex	<b>Orion</b>	<90 000	100% polyester		X		OEKO-TEX® CONFIDENCE IN TEXTILES STANDARD 100	 
Nevotex	<b>Fiesta</b>	70 000	100% polyester	Part 1 only	X		OEKO-TEX® CONFIDENCE IN TEXTILES STANDARD 100	
Nevotex	<b>Lido/Lido Trend</b>	115 000	100% polyester	Part 1 only	X		OEKO-TEX® CONFIDENCE IN TEXTILES STANDARD 100	
Nevotex	<b>Stella</b>	80 000	100% polyester		X		OEKO-TEX® CONFIDENCE IN TEXTILES STANDARD 100	
Nevotex	<b>Story</b>	100 000	100% polyester		X		OEKO-TEX® CONFIDENCE IN TEXTILES STANDARD 100	
Textum	<b>Lotos</b>	100 000	80% PES 20% CO base fabric / 100% PU surface		X			



## Price category 2

Brand	Design	Martindale	Composition	Flammability standard			Sustainability	Other
				EN 1021 1 & 2	BS 5852 Part 1 0 & 1	BS 5852 Part 2 5 CRIB		
AquaClean	<b>Altamura</b>	80 000	81% polyester 12% macintosh 6% cotton 1% nylon	X			OEKO-TEX® CONFIDENCE IN TEXTILES STANDARD 100	aqua clean TECHNOLOGY
AquaClean	<b>Daytona</b>	200 000	51% polyester 38% acrylic 11% polyamide	X	X		OEKO-TEX® CONFIDENCE IN TEXTILES STANDARD 100	aqua clean TECHNOLOGY
Blue Company	<b>Dama</b>	>60 000	70% wool 20% polyester 5% polyamide 5% acrylic (recycled wool)	X	X	X	 	
Camira	<b>Era*</b>	100 000	100% polyester	X		X	OEKO-TEX® CONFIDENCE IN TEXTILES STANDARD 100	10 YEAR
Camira	<b>Rivet</b>	80 000	100% REPREVE® recycled polyester	X		X	OEKO-TEX® CONFIDENCE IN TEXTILES STANDARD 100	 10 YEAR
Camira	<b>Vita</b>	100 000	Surface: 98% PVC 2% PU Substrate: 100% cotton	X		X	On request 	
Camira	<b>Manhattan</b>	100 000	100% post-consumer recycled polyester	X			 	10 YEAR
Camira	<b>RePlay</b>	100 000	100% post-consumer recycled polyester	X		X	OEKO-TEX® CONFIDENCE IN TEXTILES STANDARD 100	 10 YEAR
Gabriel	<b>Cura</b>	100 000	98% post-consumer recycled polyester 2% polyester	X	X		OEKO-TEX® CONFIDENCE IN TEXTILES STANDARD 100	 10 YEAR
Nevotex	<b>Pod CS</b>	65 000	100% Trevira CS	X		X		
Nevotex	<b>Wooly</b>	150 000	70% recycled wool 25% polyamide 5% blended fibre	X	X			
Textafoam	<b>Aston</b>	70 000	100% polyester		X		OEKO-TEX® CONFIDENCE IN TEXTILES STANDARD 100	

\* Except the fabric tones listed in Price category 1

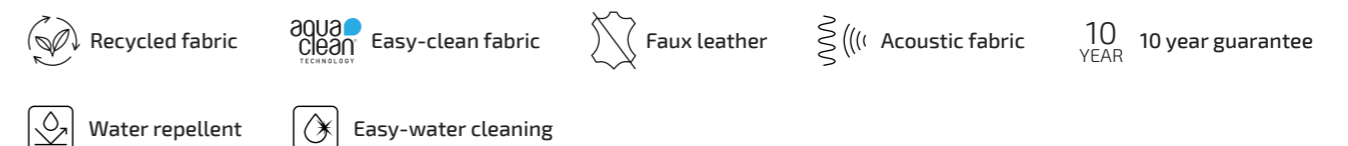

### Price category 3

Brand	Design	Martindale	Composition	Flammability standard			Sustainability	Other	
				EN 1021 1 & 2	BS 5852				IMO
					Part 1 0 & 1	Part 2 5 CRIB			
Agua	<b>Taurus</b>	400 000	2% vinyl acrylic 74% PVC 12% PES 12% cotton	X		X			
Camira	<b>Main Line Flax</b>	50 000	70% virgin wool 30% flax	X		X	On request 	10 YEAR	
Camira	<b>Main Line Twist</b>	50 000	75% virgin wool 30% flax	X		X		10 YEAR	
Camira	<b>Oceanic</b>	100 000	100% post-consumer recycled polyester incl 50% SEAQUAL® YARN	X		X	 	10 YEAR	
Camira	<b>Sumi</b>	100 000	90% wool 10% polyamide	X		X	On request 	10 YEAR	
Camira	<b>Synergy</b>	100 000	95% virgin wool 10% polyamide	X		X	On request 	10 YEAR	
Gabriel	<b>Blend</b>	100 000	100% post-consumer recycled polyester	X			 	10 YEAR	
Gabriel	<b>Step Melange</b>	100 000	100% Trevira CS	X	X	X	  	10 YEAR	
Kvadrat	<b>Relate</b>	80 000	100% Trevira CS	X		X	 	10 YEAR	
Nevotex	<b>Blues CS</b>	80 000	100% Trevira CS	X		X	 		
Nevotex	<b>Techno CS</b>	100 000	100% Trevira CS	X		X			
Spradling	<b>Silvertex</b>	300 000	100% vinyl topcoat 100% polyester backing	X					



### Price category 4

Brand	Design	Martindale	Composition	Flammability standard			Sustainability	Other	
				EN 1021 1 & 2	BS 5852				IMO
					Part 1 0 & 1	Part 2 5 CRIB			
Camira	<b>Blazer</b>	50 000	100% virgin wool	X		X	On request	10 YEAR	
Camira	<b>Kyoto</b>	100 000	90% wool 10% polyamide	X		X	On request 	10 YEAR	
Camira	<b>Yoredale</b>	50 000	95% wool 3% polyester 2% polyamide	X		X	On request	10 YEAR	
Gabriel	<b>Fame</b>	200 000	95% New Zealand wool 5% polyamide	X		X	  	10 YEAR	
Kvadrat	<b>Remix 3</b>	100 000	90% new wool, worsted 10% nylon		X	X	 	10 YEAR	

### Price category 5

Brand	Design	Martindale	Composition	Flammability standard			Sustainability	Other	
				EN 1021 1 & 2	BS 5852				IMO
					Part 1 0 & 1	Part 2 5 CRIB			
Kvadrat	<b>Canvas 2</b>	100 000	90% new wool, worsted 10% nylon	X	X	X	 	10 YEAR	
Kvadrat	<b>Steelcut Quartet</b>	100 000	90% new wool, worsted 10% nylon	X	X	X	 	10 YEAR	
Kvadrat	<b>Steelcut Trio 3</b>	100 000	90% new wool 10% nylon	X	X		 	10 YEAR	

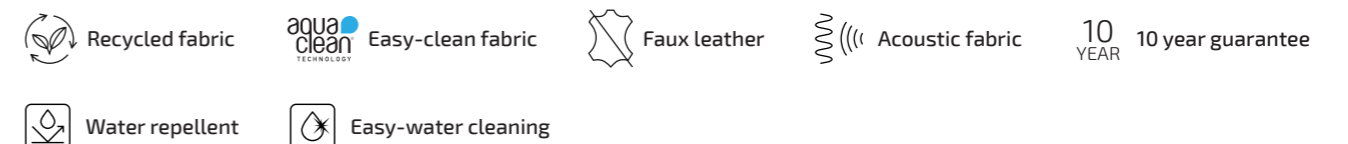

# Plug-in options

Different options available by request



Plug-in options under the surface

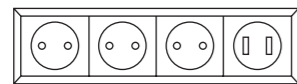

**BACHMANN POWER STRIPS**  
Electric outlet: 3x220W+ 2xUSB  
UK, CH, IT, UTE (France), DK, EU

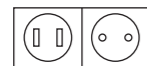

**POWERDOT Mini 51 mm**  
Electric outlet: 220W + 2xUSB  
EU



Integrated Plug-in options

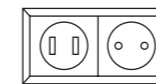

**BERKER INTEGRO FLOW**  
Integrated electric outlet: 220W + 2xUSB  
**Socket outlet with earthing contact**  
USA/Canada NEMA 5-15 R, USA/Canada NEMA 6-20 R, Australia 10 A, AUSTRALIA 15 A, Denmark, EU, Italy, Switzerland type 13, Switzerland type 23, British standard, Netherlands, Euro-American standard  
**Socket outlet with earthing pin**



**BERKER INTEGRO FLOW HDMI**  
(Applicable: August Workbay)  
High definition socket outlet with HDMI™ double jack type A, supports HDMI™ technology (V 1.3 with Deep Color)



**POWERDOT Mini 51 mm**  
Electric outlet: 220W + 2xUSB  
EU



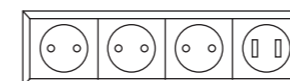

**POWERDOT 79 mm**  
Integrated electric outlet: 220W + 2xUSB  
EU, DK, UK, FR, CH



**BACHMANN POWER STRIPS**  
(Applicable: August Workbay)  
Electric outlet: 3x220W+ 2xUSB  
UK, CH, IT, UTE (France), DK, EU

**intuit**  
BY SOFTREND

-  [intuitoffice.com](https://intuitoffice.com)
-  [intuit\\_office](https://www.instagram.com/intuit_office)
-  [Intuit Office](https://www.linkedin.com/company/intuit-office)