



PLATFORM  
FOR  
FURNITURE





**SDC\_lab is furniture platform** specialised in the production of soft coating on flexible elements such as foam.

Our expertise makes us a strong partner in customized projects, regardless of finishing or materials used.

Starting from the mind of an architect to the finished product on the floor. We're able to guide you along these steps.

Because of the expertise SDC\_lab is the privileged partner for producing and commercializing products under the QUINZE & MILAN™ label

This pricelist is a guideline through the collection items and is also a base document for the first steps towards customizing.

Contact us for more information!

#### FOR YOUR CONVENIENCE

3	COATING FOAMSKIN COLOR SWATCHES
5	IMPORTANT NOTES ON THE PRICELIST
7	FINISHING SPECIFICATIONS

#### COLLECTIONS & SPECIFICATIONS

page	collection	design		
10	ACA ALLA - NEW PRODUCT 2022		92	QUARTZ
20	AIRBENCH		94	RONDO
24	CAMPING		98	ROOM 26
26	CLUB		100	ROUND CAKE
30	DAI		102	RPBW
34	DOK		106	SCONE
36	DEER		110	SEATTLE CROSS
38	GALETTE		112	SHAPES & CURVES
40	GAP		118	SKEW
44	FRAME		120	SLING - NEW PRODUCT 2022
46	INFINITY		126	SQUARES
50	LEAF BENCH		128	STRAIGHTS
54	LEAN		130	STAIR SEAT
56	LITTLE MISS O		132	UDA
60	M2		134	CUSTOMIZATION
62	MATRASS		136	UPGRADES
64	NORA		137	SCREENPRINTING
76	OSAKA		138	POWER INTEGRATION
80	PENTAGON		139	MINIMIZE
82	PILOT		140	FEET & BASES
86	PODIUM SEAT		141	OUTDOOR
88	PRIMARY		142	TERMS & CONDITIONS OF SALE



## COLOUR SWATCHES FOR FOAMSKIN COATING QMFOAM / QMPLUS / QMTEX

Based on our technology we will match the indicated NCS, PANTONE and RAL colors as precise as possible. Minimum color differences for every production batch are unavoidable. You may demand us to produce a sample first, at the cost of €150,- (shipping included) per sample

Of course "WE LOVE COLOR", but just be aware that not all people appreciate color. our products need cleaning and respect from people. Lighter colours need more cleaning and more caution than darker colors; This is why we split up our range into "contractsafe" colors and the rest of our range. Up to your choice!

### CONTRACT SAFE COLOURS

THESE PRINTED COLORS ARE ONLY AS A REFERENCE TO THE REAL COLOR, THEY ARE NOT THE EXACT COLORS. CHECK YOUR SAMPLES FOR REAL COLORS

05.Dark purple

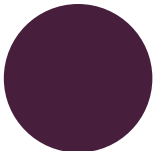

NCS: S7020R30B

06.Purple

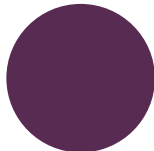

NCS: S6030R40B

08.Raspberry

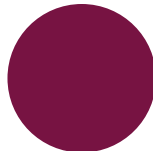

NCS: S4050R20B

14.Black

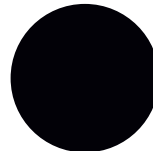

RAL: 9005

17.Anthracite

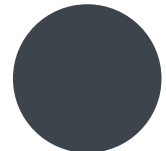

RAL: 7024

16.Red



RAL: 3020

36.Evening

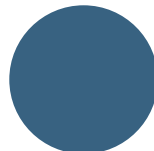

NCS: S5030R90B

35.Blue clair

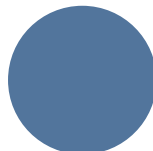

NCS: S3065R90B

41.Army



NCS: S7010G50Y

40.Pinetree

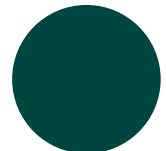

NCS: S7020B70G

12.Ochre



NCS: S3560Y20R

33.Moutarde

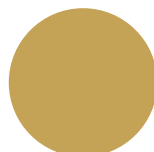

NCS: S4050Y

42.Steel blue

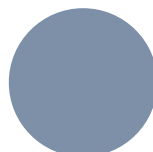

NCS: S3020R90B

07.Magenta

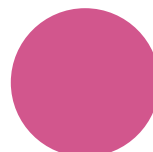

NCS: S1070R20B

### COLOURS WITH CARE

THESE PRINTED COLORS ARE ONLY AS A REFERENCE TO THE REAL COLOR, THEY ARE NOT THE EXACT COLORS. CHECK YOUR SAMPLES FOR REAL COLORS

18.White



RAL: 9016

28.Cream



RAL: 9001

39.Silver

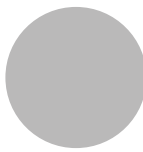

NCS: S2505R

09.Sky blue

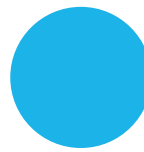

NCS: S1060B

37.Turquoise

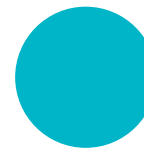

NCS: S1050B30G

44.Flamingo

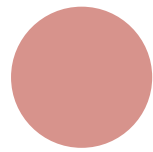

NCS: S2030R

38.Pastel green



NCS: S0540G50Y

10.Lime green



NCS: S1075G50Y

23.Chartreuse



NCS: S1080G30Y

43.Gold

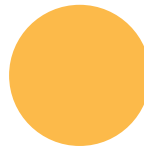

NCS: S3060Y10R

45.Merengue

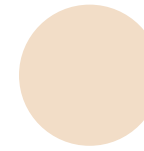

NCS: S0505Y50R

02.Sand

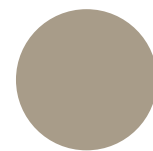

NCS: S4010Y10R

24.Orange



RAL: 2000

34.Fiesta



NCS: S0585Y70R

26.Fire



RAL: 2002

25.Yellow



NCS: S0580Y

32.Jaune pastel



NCS: S0540Y

03.Taupe



NCS: S6010Y10R

# IMPORTANT REMARKS



THE PRICES ARE CALCULATED WITH THE IDEA THAT THAT EVERYTHING IS DONE IN ONE COLOR.  
ONCE YOU REQUIRE AN ADDITIONAL COLOR WITHIN AN ORDER, YOU MUST ADD A COLOR CHANGE.  
WE CHARGE A SMALL ADDITIONAL FEE IN THE FUTURE PER COLOR, TO BE APPLIED FROM THE SECOND COLOR.  
THIS IS REGARDLESS OF THE NUMBER OF PIECES PER COLOR.  
THE PRICES FOR THIS COLOR CHANGE IS MENTIONED AT THE END OF THE PRICE LIST.



## DELIVERY CHARGES

Delivered free for all orders with a value of > 900 euros  
For all orders with a value < 900 euros, a fixed amount of      will be charged for ordering costs.

## Transport damages

Please note that in case you receive visual damaged goods you have to mark this clearly on the delivery sheet of the forwarder. It's imperative that you send a copy of this immediately to SDC email to [info@sdclab.be](mailto:info@sdclab.be).  
If you fail to provide the delivery note with your remarks, we reject all transport claims.

## Changing orders

Please note that changes of size and quality are only possible after approval of our internal sales office. These changes may lead to extra costs.

## Cancellations

For all orders which are cancelled, 30% of the total amount will be charged.

## Tolerances

We want to inform that all our qualities are subject to tolerances (weight, height, structure, colour, ...)

## Claims

Claims of faulty goods must be made within 7 days after delivery. Please send your claim well specified, together with photos to your contacts at the office of SDC. If you have a problem with a product, we kindly ask you to prepare this immediately for return.  
This will improve the speed of handling claims.  
Don't use the faulty products without an approval of our office.

## Technical details

All technical details can be provided on demand, or you can find them in the product catalogue or on our website.

## Payment

ALL ORDERS WITH A VALUE > 10.000 EURO REQUIRE SPECIAL PAYMENT CONDITIONS.  
IF NOT CLEARLY MARKED, THE FOLLOWING CONDITIONS WILL BE USED:  
--> 50% WITH ORDER CONFIRMATION  
(PRODUCTION WILL NOT BE INITIALIZED BEFORE THIS PAYMENT IS RECEIVED.)  
--> 50% BEFORE SHIPMENT  
(GOODS WILL NOT BE RELEASED BEFORE THIS PAYMENT)

## Order for upholstered pieces and customized items

ALL ORDERS WITH A VALUE > 10.000 EURO REQUIRE SPECIAL PAYMENT CONDITIONS.  
IF NOT CLEARLY MARKED, THE FOLLOWING CONDITIONS WILL BE USED:  
--> 50% WITH ORDER CONFIRMATION  
(PRODUCTION WILL NOT BE INITIALIZED BEFORE THIS PAYMENT IS RECEIVED.)  
--> 50% BEFORE SHIPMENT  
(GOODS WILL NOT BE RELEASED BEFORE THIS PAYMENT)

## Finishing

The finishing is under continuous development for some types of furniture. But some pieces still have to be calculated. Check the sales office for more detailed information.  
Please contact your agent for more information and help.

0 = product price in calculation - contact our office for pricing

# IMPORTANT NOTE ON THE PRICELIST

Since 2017 we only quote NET prices, so [THIS PRICE LIST IS NET, VAT EXCLUDED](#).

Another important notice:

THE PRICES ARE CALCULATED WITH THE IDEA THAT THAT EVERYTHING IS DONE IN ONE COLOR.

So once you require an additional color within an order, you must add a color change.

We charge a small additional fee in the future per color, to be applied from the second color.

This is regardless of the numbers of per color.

The price of this color change is indicated in the pricelist and on your quotation.

If we do not know the number of colors at the time of the quote, we will calculate 1 color change for the time being.

Don't find your color in our color swatch, no problemo!

We do custom colors at a small extra cost. This cost is not per item, but per color!

IMPORTANT:

if delivery is requested on site, thank you to do the necessary to provide a responsible person who can receive the goods.

SDC can not be held responsible for the delivery schedules of the carrier and any delays and can not accept any compensation on this subject.

The best is to request delivery in a warehouse that can receive the goods in mint conditions.

Additional charges may apply for all deliveries by truck with a tail lift.

.....  
Colors - Color QM range - color

.....  
colors - color custom NCS/RAL - color



PLATFORM  
FOR  
FURNITURE





### QM FOAMSKIN™ foamcoating

QM Foam foamcoating refers to the result of a chemical reaction between the polyurethane foam shape and different layers, with different compositions, sprayed on to it. This results in a highly flexible coating to be compared to your skin.



### QM PLUS™ foamcoating

QM Plus refers to the result of a chemical reaction between the polyurethane foam shape and different layers, with different compositions, sprayed onto it. The QM PLUS finishing has 2 layers of the foamcoating which results in a surface which has stronger resistance.



### QM TEX™ texcoating

QM TEX is a coating applied to textiles. The result is a stiff and strong material, very durable, virtually tearproof and easy to clean. The interest of this innovation is to meet the growing need of invulnerability associated with furniture solutions, walls, reception desks, while maintaining a soft touch. Like most of our products, Skintex allows a wide range of possibilities for customization: wide choice of colors, shapes, patterns, as well as the possibility to combine different materials with diverse mediums and kinds of coating, maintaining our known quality standards for the final product. This finishing is one of our own developments.



### UPHOLSTERED



#### C.O.M. Upholstered in Client's Own Materials (fabric or leather)

For specific quantities, please contact us. / more info: Terms & Conditions of Sale

#### CAT.01 Upholstered in fabrics indicated by SDC lab as price category 01

#### CAT.02 Upholstered in fabrics indicated by SDC lab as price category 02



### CURRENT COLLECTIONS

This is just a selection of fabrics we can supply

- CAT.01 Step by Gabriel  
Remix by Kvadrat  
Stamskin-Top  
Silvertex  
Sunbrella by Dickson
- CAT.02 Camira Blazer  
Topia by Rohi  
Novum by Rohi  
Divina, Divina Melange by Kvadrat



**VESCOM**



**Gabriel®**

**Serge Ferrari**

**kvadrat**



Founders of the Quinze & Milan label Arne Quinze & Yves Milan

0 = product price in calculation - contact our office for pricing



# *Quinze & Milan*<sup>TM</sup>

## INTRODUCING QUINZE & MILAN

Quinze & Milan is not a typical designer furniture label .

Quinze & Milan<sup>TM</sup> Collections go beyond furniture design.

Our products prompt you to spin tales, to dream and to shape a reality all your own.

Quinze & Milan is a platform, a label with an enormously fascinating synergy, that features the work of designers.

We like to push the boundaries – our own and those of the people around us.

In our cosmos, boundaries exist only to be shifted...

# ACA ALLA

DESIGN Bjorn Vande Vijvere

2021



0 = product price in calculation - contact our office for pricing

# ACA ALLA

DESIGN Björn Vande Vijvere

2021



> Acà Allà

> Design by Björn Vande Vijvere, 2020

> This design started with the idea of building a piece of furniture that adapts to the needs of the user. It was important to me to design a system that was able to 'grow' by adding more features to the base parts. I love it when someone else can use my work as the basis for his own creativity. Therefore the design has been kept very clean, simple and very modular. One could form a long swirling line with my design, a circle for a more intimate feeling or scatter it around throughout the space. Hence the name "acà allà", two words often used in Latin America: Somewhere over here.. Somewhere over there.. I am very curious to see what people will come up with when they start using it...



 **acà allà**  
here, there and everywhere

0 = product price in calculation - contact our office for pricing

ACA ALLA SEAT 60

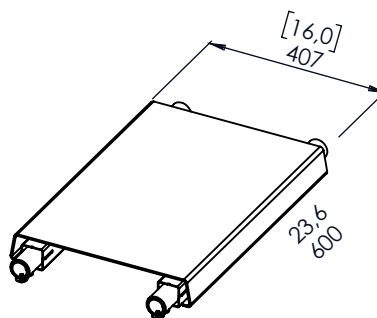

ACA ALLA SEAT 120

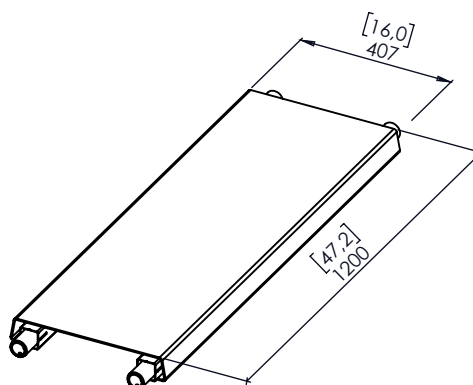

ACA ALLA SEAT 180

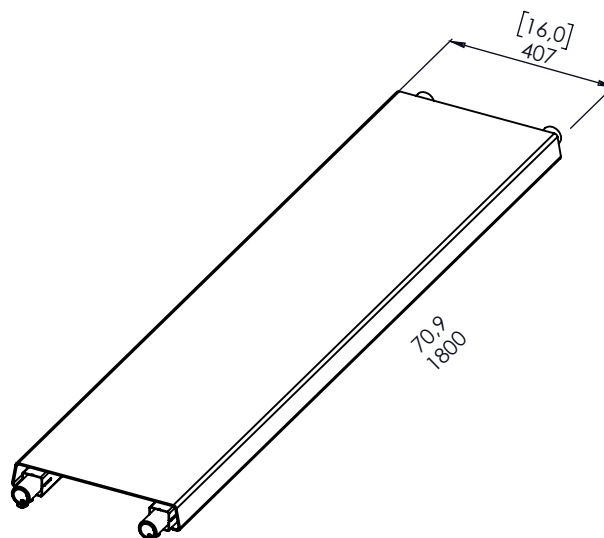

0 = product price in calculation - contact our office for pricing

# ACA ALLA

DESIGN Bjorn Vande Vijvere  
2021



## ACA ALLA LEG

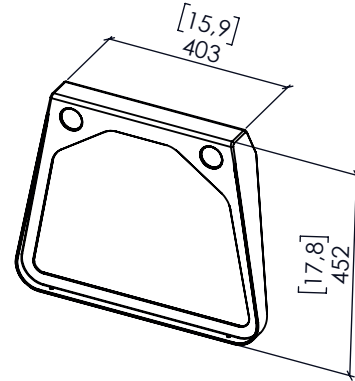

## ACA ALLA TWIST

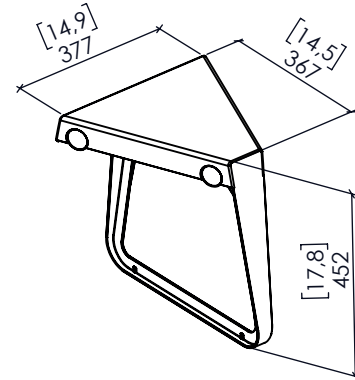

## ACA ALLA TABLE

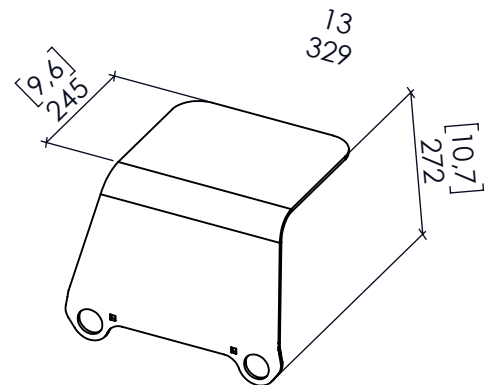

price per piece for loose elements

Acà allà bench 60
Acà allà bench 120
Acà allà bench 180
Acà allà leg
Acà allà twist
Acà allà seat 60
Acà allà seat 120
Acà allà seat 180
Acà allà table

0 = product price in calculation - contact our office for pricing

# ACA ALLA

DESIGN Bjorn Vande Vijvere

2021



Acà Allà seating system consists of some basic parts, which can be connected in a modular way to meet the needs in your setting.

We have 1 basic straight leg and a twist leg. This 'Twist leg' allows you to change the direction of your bench.

The next pages contain more information on possible settings.

price per piece for proposed configurations

Acà Allà configuration 1

Acà Allà configuration 2

Acà Allà configuration 3

Acà Allà configuration 4

Acà Allà configuration 5

Acà Allà configuration 6

Acà Allà configuration 7

Acà Allà configuration 8



0 = product price in calculation - contact our office for pricing

# ACA ALLA

DESIGN Bjorn Vande Vijvere

2021

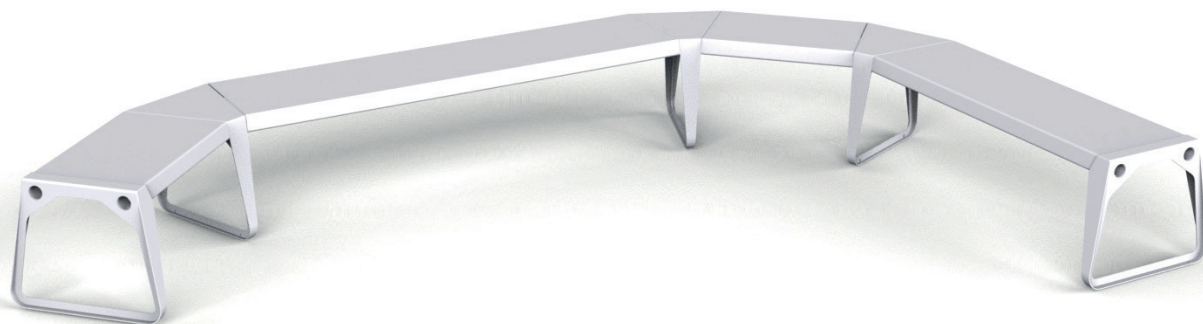

## **ACA ALLA configuration 1**

This configuration is built with the following parts  
2 legs, 3 twist legs, 2 seat 60, 1 seat 120, 1 seat 180



## **ACA ALLA configuration 2**

This configuration is built with the following parts  
2 legs, 2 twist legs, 3 seat 60

0 = product price in calculation - contact our office for pricing

# ACA ALLA

DESIGN Bjorn Vande Vijvere

2021



### **ACA ALLA configuration 3**

This configuration is built with the following parts

2 legs, 1 twist legs, 1 seat 60, 1 seat 120



### **ACA ALLA configuration 4**

This configuration is built with the following parts

2 legs, 1 seat 60, 1 table

0 = product price in calculation - contact our office for pricing



# ACA ALLA

DESIGN Bjorn Vande Vijvere  
2021



## **ACA ALLA configuration 5**

This configuration is built with the following parts  
2 legs, 1 seat 120



## **ACA ALLA configuration 6**

This configuration is built with the following parts  
2 legs, 2 leg twist, 2 seat 60, 1 seat 180

0 = product price in calculation - contact our office for pricing

# ACA ALLA

DESIGN Bjorn Vande Vijvere

2021



## **ACA ALLA configuration 7**

This configuration is built with the following parts

2 legs, 2 leg twist, 2 seat 60, 1 seat 180



## **ACA ALLA configuration 8**

This configuration is built with the following parts

2 legs, 1 seat 180

0 = product price in calculation - contact our office for pricing

ACA ALLA

DESIGN Bjorn Vande Vijvere

2021



0 = product price in calculation - contact our office for pricing

Acà allà bench 60	ACA.ALLA.BEN60	€ 1.426	10.697
Acà allà bench 120	ACA.ALLA.BEN120	€ 1.856	13.924
Acà allà bench 180	ACA.ALLA.BEN180	€ 2.866	21.497
Acà allà leg	ACA.ALLA.LEG	€ 373	2.800
Acà allà twist	ACA.ALLA.TWI	€ 591	4.434
Acà allà seat 60	ACA.ALLA.SEA60	€ 861	6.456
Acà allà seat 120	ACA.ALLA.SEA120	€ 1.137	8.531
Acà allà seat 180	ACA.ALLA.SEA180	€ 1.137	8.531
Acà allà table	ACA.ALLA.TAB	€ 197	1.478



0 = product price in calculation - contact our office for pricing



As an ultimate communication tool, an bench setting creates a landscape of human interaction. Available in variable shapes — crosses, rectangles or meanders — these benches are multifunctional and modular, offering endless combination possibilities. By accident people meet each other as they take place on the bench and immediately look into the opponents eyes. Staying silent is no longer an option as it burdens you with an unpleasant feeling.

Verbal and social interaction, giving new energy and impulses, becomes the only standard in community life.

On the Single and Double bench, people receive glimpses of each other and start communicating out of curiosity. People get interwoven by interaction. They are forced to sit in an open atmosphere and cocooning is very much a memory from the past. Due to the philosophy behind them, benches are the ideal communication tools in public areas; musea, exhibitions, libraries, lounges, airports, waiting areas,...

Custom color or sizes are available upon request.

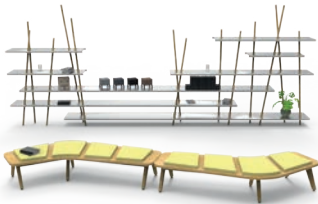

ABENCH SINGLE 01

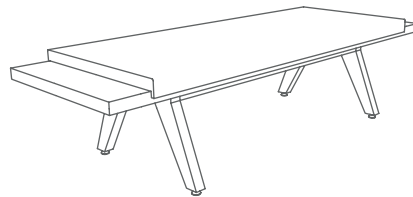
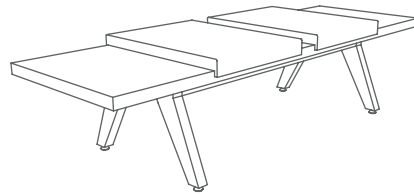

- ..... A'bench - 01 Base - Oak fineer
- ..... A'bench - 01 single seat integration - QM Foam skin
- ..... A'bench - 01 single seat integration - QM Plus foamskin double
- ..... A'bench - 01 single seat integration - QM Tex foamskin tex
- ..... A'bench - 01 single seat integration - fabric CAT 1
- ..... A'bench - 01 single seat integration - fabric CAT 2
- ..... A'bench - 01 single seat integration - fabric CAT 0/COM
- ..... A'bench - 01 double seat integration - QM Foam skin
- ..... A'bench - 01 double seat integration - QM Plus foamskin double
- ..... A'bench - 01 double seat integration - QM Tex foamskin tex
- ..... A'bench - 01 double seat integration - fabric CAT 1
- ..... A'bench - 01 double seat integration - fabric CAT 2
- ..... A'bench - 01 double seat integration - fabric CAT 0/COM

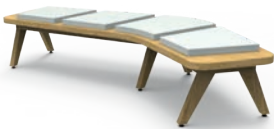

ABENCH SMALL BOOMERANG

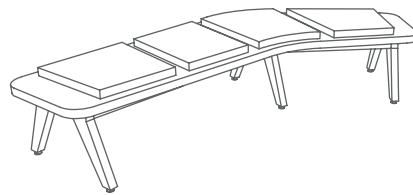

- ..... A'bench - Small Boomerang incl. Cushions - QM Foam skin
- ..... A'bench - Small Boomerang incl. Cushions - QM Plus foamskin double
- ..... A'bench - Small Boomerang incl. Cushions - QM Tex foamskin tex
- ..... A'bench - Small Boomerang incl. Cushions - fabric CAT 1
- ..... A'bench - Small Boomerang incl. Cushions - fabric CAT 2
- ..... A'bench - Small Boomerang incl. Cushions - fabric CAT 0/COM

All other models and variations of our Airbench, such as Airbench 02 and small cross are available on request. Please contact our sales office for the right pricing.

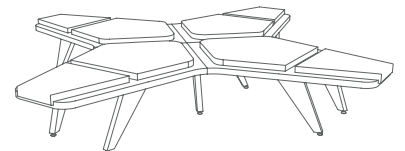
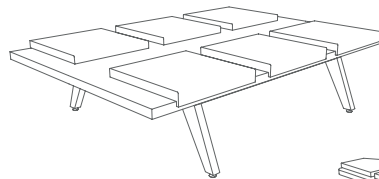
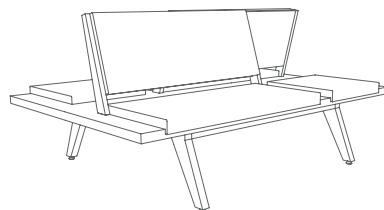
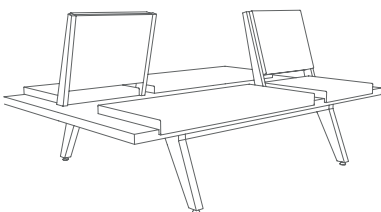

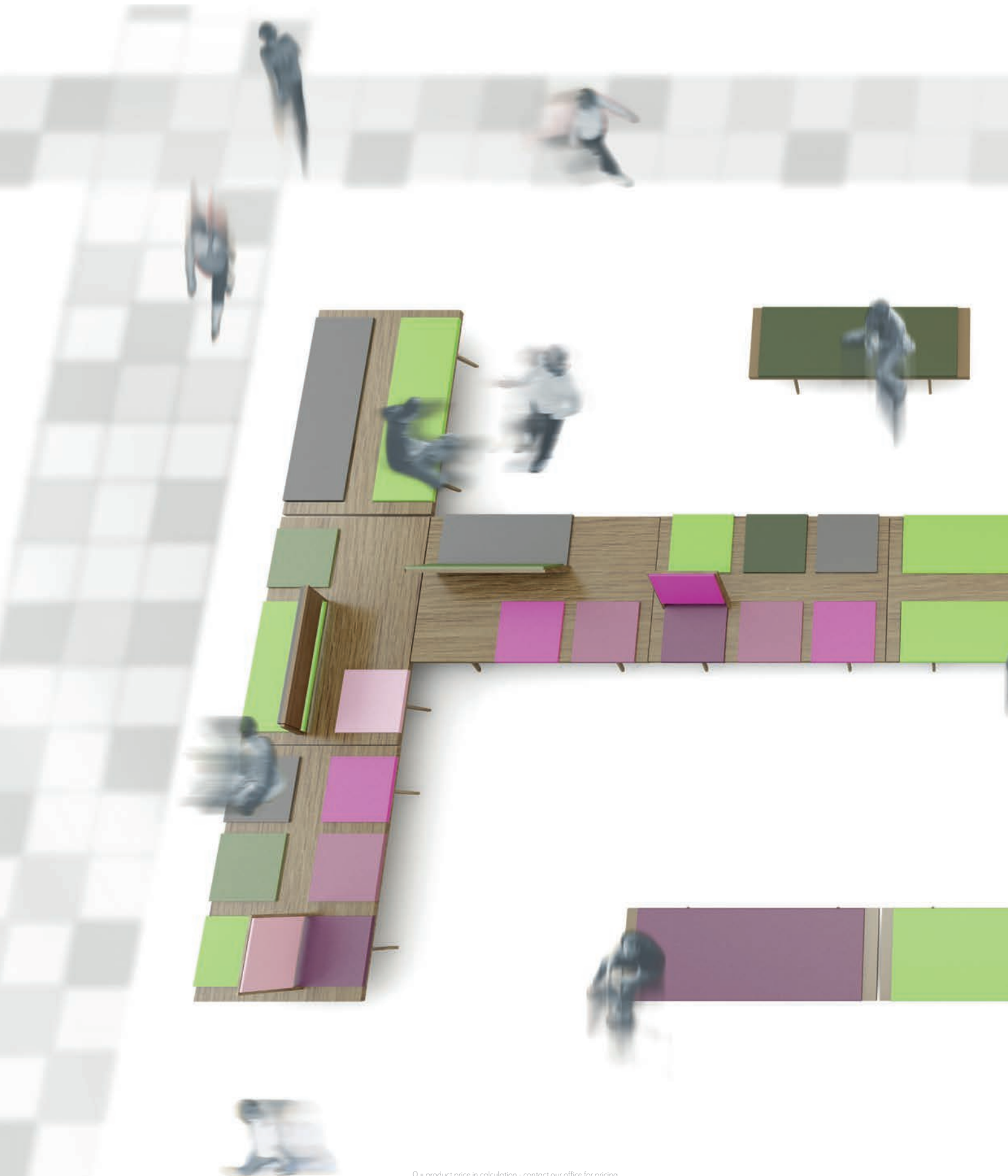

0 = product price in calculation - contact our office for pricing



0 = product price in calculation - contact our office for pricing



A'bench - 01 Base - Oak fineer	WO.ABE.01.BAS	€ 1.533	11.496
A'bench - 01 single seat integration - QM Foam	QF.ABE.01.SSI	€ 330	2.474
A'bench - 01 single seat integration - QM Plus	QP.ABE.01.SSI	€ 363	2.719
A'bench - 01 single seat integration - QM Tex	QT.ABE.01.SSI	€ 381	2.855
A'bench - 01 single seat integration - fabric CAT 2	QU2.ABE.01.SSI	€ 404	3.031
A'bench - 01 single seat integration - fabric CAT 0/COM	QU0.ABE.01.SSI	€ 319	2.396
A'bench - 01 double seat integration - QM Foam	QF.ABE.01.DSI	€ 837	6.276
A'bench - 01 double seat integration - QM Plus	QP.ABE.01.DSI	€ 957	7.177
A'bench - 01 double seat integration - QM Tex	QT.ABE.01.DSI	€ 1.007	7.552
A'bench - 01 double seat integration - fabric CAT 1	QU1.ABE.01.DSI	€ 868	6.510
A'bench - 01 double seat integration - fabric CAT 2	QU2.ABE.01.DSI	€ 1.084	8.133
A'bench - 01 double seat integration - fabric CAT 0/COM	QU0.ABE.01.DSI	€ 774	5.804
A'bench - 02 Base - Oak fineer	WO.ABE.02.BAS	€ 3.248	24.357
A'bench - 02 single seat integration - QM Foam	QF.ABE.02.SSI	€ 325	2.436
A'bench - 02 single seat integration - QM Plus	QP.ABE.02.SSI	€ 355	2.661
A'bench - 02 single seat integration - QM Tex	QT.ABE.02.SSI	€ 536	4.022
A'bench - 02 single seat integration - fabric CAT 1	QU1.ABE.02.SSI	€ 523	3.926
A'bench - 02 single seat integration - fabric CAT 2	QU2.ABE.02.SSI	€ 582	4.369
A'bench - 02 single seat integration - fabric CAT 0/COM	QU0.ABE.02.SSI	€ 498	3.733
A'bench - 02 double seat integration - QM Foam	QF.ABE.02.DSI	€ 569	4.265
A'bench - 02 double seat integration - QM Plus	QP.ABE.02.DSI	€ 634	4.755
A'bench - 02 double seat integration - QM Tex	QT.ABE.02.DSI	€ 1.327	9.955
A'bench - 02 double seat integration - fabric CAT 1	QU1.ABE.02.DSI	€ 1.330	9.972
A'bench - 02 double seat integration - fabric CAT 2	QU2.ABE.02.DSI	€ 1.462	10.968
A'bench - 02 double seat integration - fabric CAT 0/COM	QU0.ABE.02.DSI	€ 1.272	9.538
A'bench - Single backrest integration - QM Foam	QF.ABE..SBI	€ 579	4.340
A'bench - Single backrest integration - QM Plus	QP.ABE..SBI	€ 606	4.543
A'bench - Single backrest integration - QM Tex	QT.ABE..SBI	€ 646	4.848
A'bench - Single backrest integration - fabric CAT 1	QU1.ABE..SBI	€ 629	4.719
A'bench - Single backrest integration - fabric CAT 2	QU2.ABE..SBI	€ 698	5.236
A'bench - Single backrest integration - fabric CAT 0/COM	QU0.ABE..SBI	€ 599	4.496
A'bench - Double backrest integration - QM Foam	QF.ABE..DBI	€ 939	7.040
A'bench - Double backrest integration - QM Plus	QP.ABE..DBI	€ 993	7.451
A'bench - Double backrest integration - QM Tex	QT.ABE..DBI	€ 1.235	9.260
A'bench - Double backrest integration - fabric CAT 1	QU1.ABE..DBI	€ 1.209	9.068
A'bench - Double backrest integration - fabric CAT 2	QU2.ABE..DBI	€ 1.327	9.953
A'bench - Double backrest integration - fabric CAT 0/COM	QU0.ABE..DBI	€ 1.158	8.683
A'bench - Small Boomerang incl. Cushions - QM Foam	QF.ABE.SBO.	€ 4.650	34.877
A'bench - Small Boomerang incl. Cushions - QM Plus	QP.ABE.SBO.	€ 4.939	37.046
A'bench - Small Boomerang incl. Cushions - QM Tex	QT.ABE.SBO.	€ 4.768	35.761

A'bench - Small Boomerang incl. Cushions - fabric CAT 1	QU1.ABE.SBO.	€ 4.076	30.566
A'bench - Small Boomerang incl. Cushions - fabric CAT 2	QU2.ABE.SBO.	€ 4.311	32.336
A'bench - Small Boomerang incl. Cushions - fabric CAT 0/COM	QU0.ABE.SBO.	€ 3.973	29.797
A'bench - Small Cross incl. Cushions - QM Foam	QF.ABE.SMC.	€ 7.236	54.272
A'bench - Small Cross incl. Cushions - QM Plus	QP.ABE.SMC.	€ 7.446	55.848
A'bench - Small Cross incl. Cushions - QM Tex	QT.ABE.SMC.	€ 8.275	62.066
A'bench - Small Cross incl. Cushions - fabric CAT 1	QU1.ABE.SMC.	€ 8.040	60.302
A'bench - Small Cross incl. Cushions - fabric CAT 2	QU2.ABE.SMC.	€ 8.483	63.619
A'bench - Small Cross incl. Cushions - fabric CAT 0/COM	QU0.ABE.SMC.	€ 7.848	58.859



0 = product price in calculation - contact our office for pricing

ROOM 26 has a look that fuses the familiar and the timeless with 'something different', offering an extensive range of products that can transform an interior into a space that shouts '26' or, when used sparingly, can conjure up a room that barely whispers the word.

Key to the collection is oak, a material playfully combined with fabric, leather or Foamskin cushions.



CAMPING table 220  
INNER or OUTER LEGS

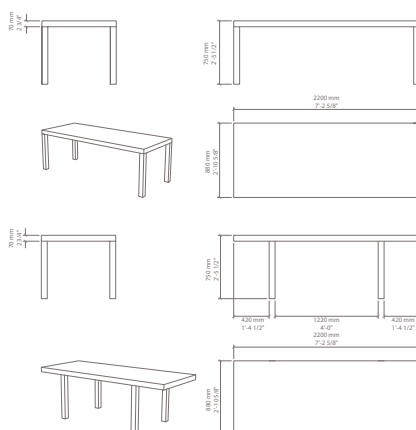

Camping Table 220 Massive Oak

CAMPING table 250  
INNER or OUTER LEGS

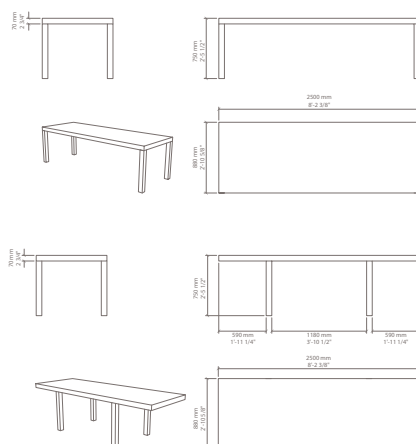

Camping Table 250 Massive oak

0 = product price in calculation - contact our office for pricing

Camping Table 220 Massive Oak	QW.CAM.TAB.220	€ 3.386	25.395
Camping Table 250 Massive oak	QW.CAM.TAB.250	€ 3.386	25.395
Camping Bench for table 220 Oak Fineer	QW.CAM.BEN.220	€ 1.283	9.620
Camping Bench for table 250 Oak Fineer	QW.CAM.BEN.250	€ 1.283	9.620
Camping Bench for table 220 with cushion QM Foam	QF.CAM.BEN.220.CUS	€ 1.719	12.890
Camping Bench for table 220 with cushion QM Plus	QP.CAM.BEN.220.CUS	€ 1.803	13.525
Camping Bench for table 250 with cushion QM Foam	QF.CAM.BEN.250.CUS	€ 1.719	12.890
Camping Bench for table 250 with cushion QM Plus	QP.CAM.BEN.250.CUS	€ 1.803	13.525





Simple, plain, bold: three words that describe the body language of CLUB, a design that seems to say: 'If the basics are right, who needs ornament?' Made from our proprietary QM FOAM™, CLUB is happy indoors and out.

After many successful years, CLUB is now enhanced with a series of new shapes and solutions. Especially the loose cushions are important additions. The seating cushions are made of a combination of memory foam and wadding to create extreme softness and comfort in just a few centimeters of thickness. The back cushions are made of goose down. All loose cushions have removable covers.

The new lateral units standard come with a straight back on the inside. But versions with an inclined inside back are possible upon request. Drawings refer to the left version.

CLUB is also available upholstered in leather and fabric.  
Custom color or sizes are available upon request.

CLUB SOFA 01

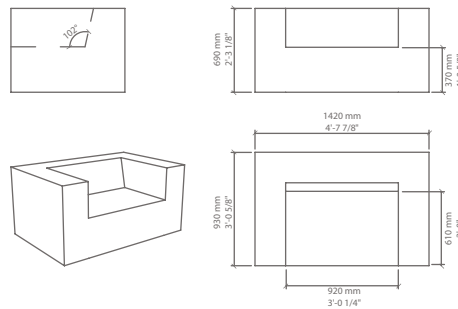
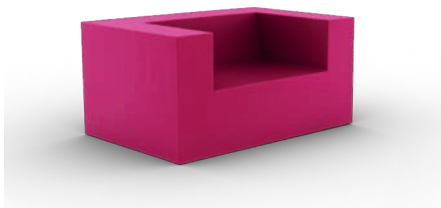

- Club sofa 01 QM Foam skin
- Club sofa 01 QM Plus foamskin double
- Club sofa 01 QM Tex foamskin Tex
- Club sofa 01 QM CAT 1
- Club sofa 01 QM CAT 2
- Club sofa 01 QM CAT 0/COM

CLUB OTTOMAN 01

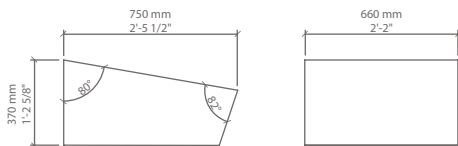

- Club ottoman 01 QM Foam skin
- Club ottoman 01 QM Plus foamskin double
- Club ottoman 01 QM Tex foamskin Tex
- Club ottoman 01 QM CAT 1
- Club ottoman 01 QM CAT 2
- Club ottoman 01 QM CAT 0/COM

CLUB SOFA 02

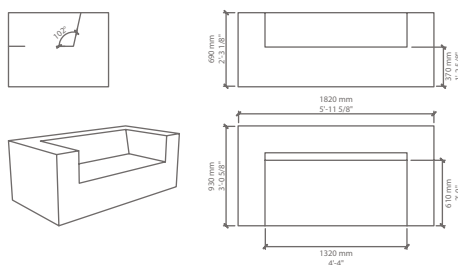

- Club sofa 02 QM Foam skin
- Club sofa 02 QM Plus foamskin double
- Club sofa 02 QM Tex foamskin Tex
- Club sofa 02 QM CAT 1
- Club sofa 02 QM CAT 2
- Club sofa 02 QM CAT 0/COM

CLUB OTTOMAN 02

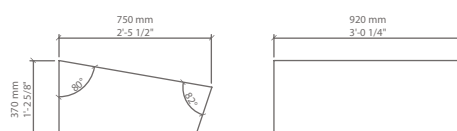

- Club ottoman 02 QM Foam skin
- Club ottoman 02 QM Plus foamskin double
- Club ottoman 02 QM Tex foamskin Tex
- Club ottoman 02 QM CAT 1
- Club ottoman 02 QM CAT 2
- Club ottoman 02 QM CAT 0/COM

0 = product price in calculation - contact our office for pricing

CLUB SOFA 03

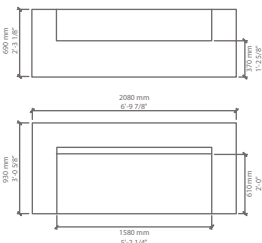
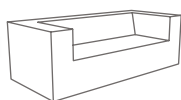

- Club sofa 03 QM Foam skin
- Club sofa 03 QM Plus foamskin double
- Club sofa 03 QM Tex foamskin
- Club sofa 03 QM CAT 1
- Club sofa 03 QM CAT 2
- Club sofa 03 QM CAT 0/COM

CLUB SOFA 04

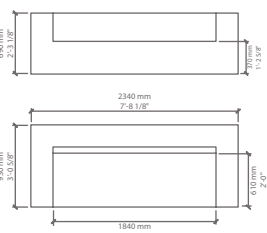
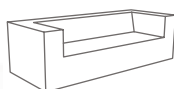

- Club sofa 04 QM Foam skin
- Club sofa 04 QM Plus foamskin double
- Club sofa 04 QM Tex foamskin Tex
- Club sofa 04 QM CAT 1
- Club sofa 04 QM CAT 2
- Club sofa 04 QM CAT 0/COM

CLUB SOFA 05

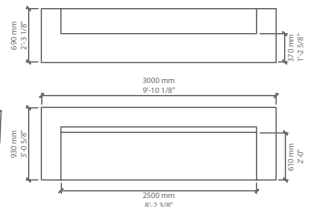
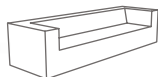

- Club sofa 05 QM Foam skin
- Club sofa 05 QM Plus foamskin double
- Club sofa 05 QM Tex foamskin Tex
- Club sofa 05 QM CAT 1
- Club sofa 05 QM CAT 2
- Club sofa 05 QM CAT 0/COM

CLUB POUF 01

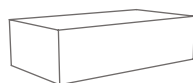
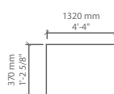
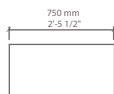

- Club pouf 01 QM Foam skin
- Club pouf 01 QM Plus foamskin double
- Club pouf 01 QM Tex foamskin Tex
- Club pouf 01 QM CAT 1
- Club pouf 01 QM CAT 2
- Club pouf 01 QM CAT 0/COM

CLUB POUF 02



- Club pouf 02 QM Foam skin
- Club pouf 02 QM Plus foamskin double
- Club pouf 02 QM Tex foamskin Tex
- Club pouf 02 QM CAT 1
- Club pouf 02 QM CAT 2
- Club pouf 02 QM CAT 0/COM

0 = product price in calculation - contact our office for pricing



CLUB SOFA 02 EXTENDED

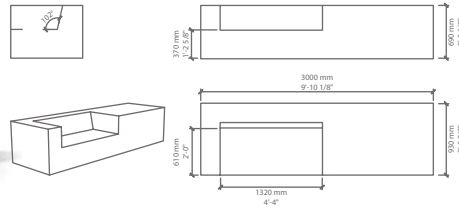

- ..... Club sofa 02 extended QM Foam skin
- ..... Club sofa 02 extended QM Plus foamskin double
- ..... Club sofa 02 extended QM Tex foamskin Tex
- ..... Club sofa 02 extended QM CAT 1
- ..... Club sofa 02 extended QM CAT 2
- ..... Club sofa 02 extended QM CAT 0/COM

CLUB SOFA 02 + 01 EXTENDED

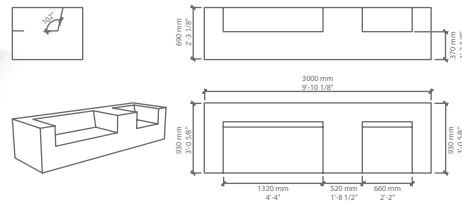

- ..... Club sofa 02 + 01 extended QM Foam skin
- ..... Club sofa 02 + 01 extended QM Plus foamskin double
- ..... Club sofa 02 + 01 extended QM Tex foamskin Tex
- ..... Club sofa 02 + 01 extended QM CAT 1
- ..... Club sofa 02 + 01 extended QM CAT 2
- ..... Club sofa 02 + 01 extended QM CAT 0/COM

CLUB LATERAL VARIATIONS

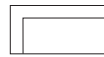

SOFA LATERAL 02

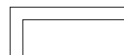

SOFA LATERAL 03



SOFA LATERAL 04

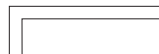

SOFA LATERAL 05

- ..... Club sofa lateral 02 QM Foam skin
- ..... Club sofa lateral 02 QM Plus foamskin double
- ..... Club sofa lateral 02 QM Tex foamskin Tex
- ..... Club sofa lateral 02 QM CAT 1
- ..... Club sofa lateral 02 QM CAT 2
- ..... Club sofa lateral 02 QM CAT 0/COM
- ..... Club Lateral 03 QM Foam skin
- ..... Club Lateral 03 QM Plus foamskin double
- ..... Club Lateral 03 QM Tex foamskin Tex
- ..... Club Lateral 03 QM CAT 1
- ..... Club Lateral 03 QM CAT 2
- ..... Club Lateral 03 QM CAT 0/COM
- ..... Club sofa lateral 04 QM Foam skin
- ..... Club sofa lateral 04 QM Plus foamskin double
- ..... Club sofa lateral 04 QM Tex foamskin Tex
- ..... Club sofa lateral 04 QM CAT 1
- ..... Club sofa lateral 04 QM CAT 2
- ..... Club sofa lateral 04 QM CAT 0/COM
- ..... Club sofa lateral 05 QM Foam skin
- ..... Club sofa lateral 05 QM Plus foamskin double
- ..... Club sofa lateral 05 QM Tex foamskin Tex
- ..... Club sofa lateral 05 QM CAT 1
- ..... Club sofa lateral 05 QM CAT 2
- ..... Club sofa lateral 05 QM CAT 0/COM

0 = product price in calculation - contact our office for pricing

Club sofa 01	QM FOAM	QF.CLU.S01	€ 3.026	22.698
Club sofa 01	QM PLUS	QP.CLU.S01	€ 3.382	25.365
Club sofa 01	QM TEX	QT.CLU.S01	€ 4.123	30.924
Club sofa 01	QM CAT 1	QU1.CLU.S01	€ 2.810	21.076
Club sofa 01	QM CAT 2	QU2.CLU.S01	€ 3.272	24.542
Club sofa 01	QM CAT 0/COM	QU0.CLU.S01	€ 2.195	16.466
Club ottoman 01	QM FOAM	QF.CLU.OT01	€ 664	4.980
Club ottoman 01	QM PLUS	QP.CLU.OT01	€ 762	5.714
Club ottoman 01	QM TEX	QT.CLU.OT01	€ 1.267	9.505
Club ottoman 01	QM CAT 1	QU1.CLU.OT01	€ 897	6.728
Club ottoman 01	QM CAT 2	QU2.CLU.OT01	€ 1.015	7.612
Club ottoman 01	QM CAT 0/COM	QU0.CLU.OT01	€ 718	5.381
Club sofa 02	QM FOAM	QF.CLU.S02	€ 3.752	28.138
Club sofa 02	QM PLUS	QP.CLU.S02	€ 4.168	31.258
Club sofa 02	QM TEX	QT.CLU.S02	€ 4.701	35.258
Club sofa 02	QM CAT 1	QU1.CLU.S02	€ 3.165	23.735
Club sofa 02	QM CAT 2	QU2.CLU.S02	€ 3.715	27.864
Club sofa 02	QM CAT 0/COM	QU0.CLU.S02	€ 2.476	18.571
Club ottoman 02	QM FOAM	QF.CLU.OT02	€ 858	6.432
Club ottoman 02	QM PLUS	QP.CLU.OT02	€ 985	7.385
Club ottoman 02	QM TEX	QT.CLU.OT02	€ 1.636	12.269
Club ottoman 02	QM CAT 1	QU1.CLU.OT02	€ 1.193	8.944
Club ottoman 02	QM CAT 2	QU2.CLU.OT02	€ 1.438	10.787
Club ottoman 02	QM CAT 0/COM	QU0.CLU.OT02	€ 925	6.939
Club sofa 03	QM FOAM	QF.CLU.S03	€ 4.176	31.323
Club sofa 03	QM PLUS	QP.CLU.S03	€ 4.638	34.786
Club sofa 03	QM TEX	QT.CLU.S03	€ 5.349	40.117
Club sofa 03	QM CAT 1	QU1.CLU.S03	€ 3.635	27.263
Club sofa 03	QM CAT 2	QU2.CLU.S03	€ 4.225	31.688
Club sofa 03	QM CAT 0/COM	QU0.CLU.S03	€ 2.850	21.372
Club sofa 04	QM FOAM	QF.CLU.S04	€ 4.572	34.291
Club sofa 04	QM PLUS	QP.CLU.S04	€ 5.080	38.097
Club sofa 04	QM TEX	QT.CLU.S04	€ 5.885	44.141
Club sofa 04	QM CAT 1	QU1.CLU.S04	€ 4.000	29.997
Club sofa 04	QM CAT 2	QU2.CLU.S04	€ 4.639	34.790
Club sofa 04	QM CAT 0/COM	QU0.CLU.S04	€ 3.134	23.504
Club sofa 05	QM FOAM	QF.CLU.S05	€ 5.781	43.360
Club sofa 05	QM PLUS	QP.CLU.S05	€ 6.407	48.052
Club sofa 05	QM TEX	QT.CLU.S05	€ 6.761	50.709
Club sofa 05	QM CAT 1	QU1.CLU.S05	€ 4.457	33.430

Club sofa 05 QM CAT 2	QU2.CLU.S05	€ 5.274	39.552
Club sofa 05 QM CAT 0/COM	QU0.CLU.S05	€ 3.461	25.960
Club pouf 01 QM FOAM	QF.CLU.P01	€ 1.435	10.763
Club pouf 01 QM PLUS	QP.CLU.P01	€ 1.627	12.200
Club pouf 01 QM TEX	QT.CLU.P01	€ 1.536	11.523
Club pouf 01 QM CAT 1	QU1.CLU.P01	€ 1.051	7.886
Club pouf 01 QM CAT 2	QU2.CLU.P01	€ 1.346	10.099
Club pouf 01 QM CAT 0/COM	QU0.CLU.P01	€ 802	6.019
Club pouf 02 QM FOAM	QF.CLU.P02	€ 3.088	23.159
Club pouf 02 QM PLUS	QP.CLU.P02	€ 3.485	26.134
Club pouf 02 QM TEX	QT.CLU.P02	€ 3.895	29.216
Club pouf 02 QM CAT 1	QU1.CLU.P02	€ 2.582	19.368
Club pouf 02 QM CAT 2	QU2.CLU.P02	€ 3.271	24.530
Club pouf 02 QM CAT 0/COM	QU0.CLU.P02	€ 1.962	14.718
Club sofa 02 extended QM FOAM	QF.CLU.S02.EXT	€ 6.241	46.809
Club sofa 02 extended QM PLUS	QP.CLU.S02.EXT	€ 6.865	51.488
Club sofa 02 extended QM TEX	QT.CLU.S02.EXT	€ 7.499	56.243
Club sofa 02 extended QM CAT 1	QU1.CLU.S02.EXT	€ 5.225	39.189
Club sofa 02 extended QM CAT 2	QU2.CLU.S02.EXT	€ 6.120	45.901
Club sofa 02 extended QM CAT 0/COM	QU0.CLU.S02.EXT	€ 4.067	30.499
Club sofa 02 + 01 extended QM FOAM	QF.CLU.S02.01	€ 6.322	47.415
Club sofa 02 + 01 extended QM PLUS	QP.CLU.S02.01	€ 6.969	52.267
Club sofa 02 + 01 extended QM TEX	QT.CLU.S02.01	€ 7.593	56.947
Club sofa 02 + 01 extended QM CAT 1	QU1.CLU.S02.01	€ 5.225	39.189
Club sofa 02 + 01 extended QM CAT 2	QU2.CLU.S02.01	€ 6.120	45.901
Club sofa 02 + 01 extended QM CAT 0/COM	QU0.CLU.S02.01	€ 4.067	30.499
Club sofa lateral 02 QM FOAM	QF.CLU.LAT.02	€ 3.427	25.704
Club sofa lateral 02 QM PLUS	QP.CLU.LAT.02	€ 3.770	28.274
Club sofa lateral 02 QM TEX	QT.CLU.LAT.02	€ 4.788	35.910
Club sofa lateral 02 QM CAT 1	QU1.CLU.LAT.02	€ 3.513	26.347
Club sofa lateral 02 QM CAT 2	QU2.CLU.LAT.02	€ 3.975	29.813
Club sofa lateral 02 QM CAT 0/COM	QU0.CLU.LAT.02	€ 2.783	20.871
Club Lateral 03 QM FOAM	QF.CLU.LAT.03	€ 3.851	28.882
Club Lateral 03 QM PLUS	QP.CLU.LAT.03	€ 4.239	31.793
Club Lateral 03 QM TEX	QT.CLU.LAT.03	€ 5.192	38.943
Club Lateral 03 QM CAT 1	QU1.CLU.LAT.03	€ 3.779	28.345
Club Lateral 03 QM CAT 2	QU2.CLU.LAT.03	€ 4.369	32.770
Club Lateral 03 QM CAT 0/COM	QU0.CLU.LAT.03	€ 2.967	22.254
Club sofa lateral 04 QM FOAM	QF.CLU.LAT.04	€ 4.249	31.868
Club sofa lateral 04 QM PLUS	QP.CLU.LAT.04	€ 4.682	35.118

Club sofa lateral 04	QM TEX	QT.CLU.LAT.04	€ 5.581	41.858
Club sofa lateral 04	QM CAT 1	QU1.CLU.LAT.04	€ 4.000	29.997
Club sofa lateral 04	QM CAT 2	QU2.CLU.LAT.04	€ 4.639	34.790
Club sofa lateral 04	QM CAT 0/COM	QU0.CLU.LAT.04	€ 3.134	23.504
Club sofa lateral 05	QM FOAM	QF.CLU.LAT.05	€ 5.880	44.097
Club sofa lateral 05	QM PLUS	QP.CLU.LAT.05	€ 6.427	48.203
Club sofa lateral 05	QM TEX	QT.CLU.LAT.05	€ 7.024	52.680
Club sofa lateral 05	QM CAT 1	QU1.CLU.LAT.05	€ 5.035	37.759
Club sofa lateral 05	QM CAT 2	QU2.CLU.LAT.05	€ 5.851	43.881
Club sofa lateral 05	QM CAT 0/COM	QU0.CLU.LAT.05	€ 3.932	29.486

DAI

DESIGN KAZUKO OKAMOTO

2009



*Quinze & milan*



0 = product price in calculation - contact our office for pricing

Kazuko Okamoto creates designs combining fun and function. Fun? A perfect cut out Dai Ottoman right out the Dai Sofa. Function? Extending the sofa with a table piece attached to the sofa. Put your laptop on your sofa! Put up your feet on the Ottoman! Recreation all in one piece of foam.

Drawings refer to the left version, the right version comes at the same price.

DAI SOFA is also available upholstered in leather and fabric.  
Custom color or sizes are available upon request.

DAI SOFA 01

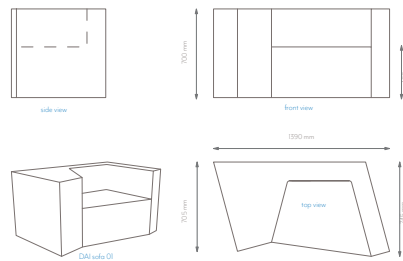

- ..... Dai sofa 01 - QM Foam skin
- ..... Dai sofa 01 - QM Plus foamskin double
- ..... Dai sofa 01 - QM Tex foamskin Tex
- ..... Dai sofa 01 - QM CAT 1
- ..... Dai sofa 01 - QM CAT 2
- ..... Dai sofa 01 - QM CAT 0/COM

\*THE DRAWINGS REFER TO THE LEFT SIDE VERSION

DAI SOFA 01 angular backrest

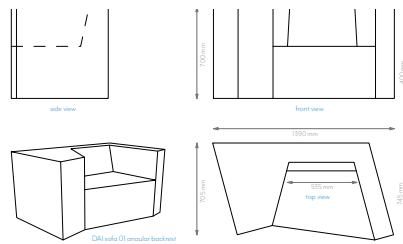

- ..... Dai Sofa 01 angular backrest - QM Foam skin
- ..... Dai Sofa 01 angular backrest - QM Plus foamskin double
- ..... Dai Sofa 01 angular backrest - QM Tex foamskin Tex
- ..... Dai Sofa 01 angular backrest - QM CAT 1
- ..... Dai Sofa 01 angular backrest - QM CAT 2
- ..... Dai Sofa 01 angular backrest - QM CAT 0/COM

DAI OTTOMAN

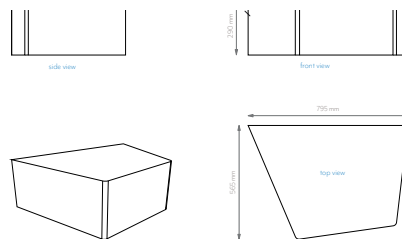

- ..... Dai ottoman - QM Foam skin
- ..... Dai ottoman - QM Plus foamskin double
- ..... Dai ottoman - QM Tex foamskin Tex
- ..... Dai ottoman - QM CAT 1
- ..... Dai ottoman - QM CAT 2
- ..... Dai ottoman - QM CAT 0/COM

DAI SOFA SOFA 02

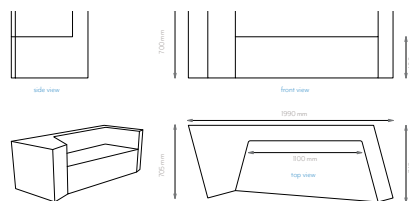

- ..... Dai sofa 02 - QM Foam skin
- ..... Dai sofa 02 - QM Plus foamskin double
- ..... Dai sofa 02 - QM Tex foamskin Tex
- ..... Dai sofa 02 - QM CAT 1
- ..... Dai sofa 02 - QM CAT 2
- ..... Dai sofa 02 - QM CAT 0/COM

0 = product price in calculation - contact our office for pricing



DAI SOFA SOFA 03

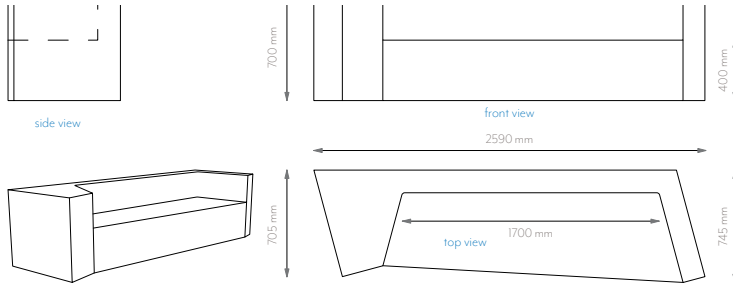

- .....
- ..... Dai sofa 03 QM Foam skin
- ..... Dai sofa 03 QM Plus foamskin double
- ..... Dai sofa 03 QM Tex foamskin Tex
- ..... Dai sofa 03 QM CAT 1
- ..... Dai sofa 03 QM CAT 2
- ..... Dai sofa 03 QM CAT 0/COM
- .....

DAI SOFA SOFA MIRROR

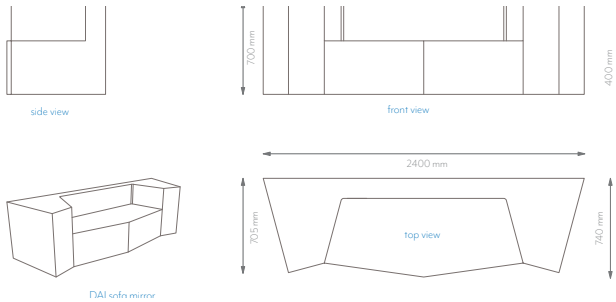
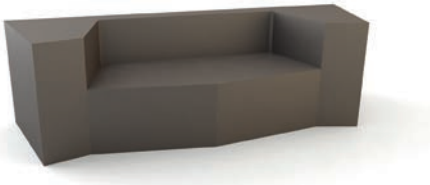

- .....
- ..... Dai mirror QM Foam skin
- ..... Dai mirror QM Plus foamskin double
- ..... Dai mirror QM Tex foamskin Tex
- ..... Dai mirror QM CAT 1
- ..... Dai mirror QM CAT 2
- ..... Dai mirror QM CAT 0/COM
- .....

DAI SOFA SOFA LATERAL

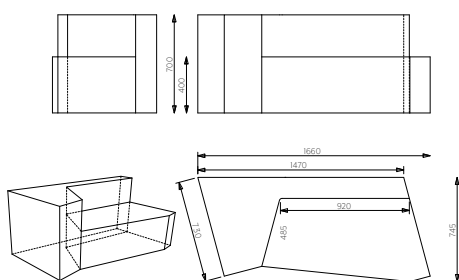

- .....
- ..... Dai lateral QM Foam skin
- ..... Dai lateral QM Plus foamskin double
- ..... Dai lateral QM Tex foamskin Tex
- ..... Dai lateral QM CAT 1
- ..... Dai lateral QM CAT 2
- ..... Dai lateral QM CAT 0/COM
- .....

0 = product price in calculation - contact our office for pricing



Dai sofa 01 QM FOAM	QF.DAI.S01	€ 2.616	19.620
Dai sofa 01 QM PLUS	QP.DAI.S01	€ 2.867	21.506
Dai sofa 01 QM TEX	QT.DAI.S01	€ 4.247	31.850
Dai sofa 01 QM CAT 1	QU1.DA.S01	€ 3.349	25.118
Dai sofa 01 QM CAT 2	QU2.DA.S01	€ 3.802	28.517
Dai sofa 01 QM CAT 0/COM	QU0.DA.S01	€ 3.152	23.640
Dai Sofa 01 angular backrest QM FOAM	QF.DAI.S01.ANGBR	€ 2.675	20.065
Dai Sofa 01 angular backrest QM PLUS	QP.DAI.S01.ANGBR	€ 2.925	21.940
Dai Sofa 01 angular backrest QM TEX	QT.DAI.S01.ANGBR	€ 4.425	33.185
Dai Sofa 01 angular backrest QM CAT 1	QU1.DAI.S01.ANGBR	€ 3.534	26.508
Dai Sofa 01 angular backrest QM CAT 2	QU2.DAI.S01.ANGBR	€ 3.985	29.886
Dai Sofa 01 angular backrest QM CAT 0/COM	QU0.DAI.S01.ANGBR	€ 3.339	25.040
Dai lateral QM FOAM	QF.DAI.LAT	€ 2.937	22.030
Dai lateral QM PLUS	QP.DAI.LAT	€ 3.211	24.081
Dai lateral QM TEX	QT.DAI.LAT	€ 5.851	43.883
Dai lateral QM CAT 1	QU1.DAI.LAT	€ 4.892	36.687
Dai lateral QM CAT 2	QU2.DAI.LAT	€ 5.384	40.382
Dai lateral QM CAT 0/COM	QU0.DAI.LAT	€ 4.677	35.080
Dai sofa 02 QM FOAM	QF.DAI.S02	€ 3.505	26.285
Dai sofa 02 QM PLUS	QP.DAI.S02	€ 3.848	28.860
Dai sofa 02 QM TEX	QT.DAI.S02	€ 6.209	46.569
Dai sofa 02 QM CAT 1	QU1.DAI.S02	€ 5.012	37.590
Dai sofa 02 QM CAT 2	QU2.DAI.S02	€ 5.630	42.228
Dai sofa 02 QM CAT 0/COM	QU0.DAI.S02	€ 4.743	35.572
Dai sofa 03 QM FOAM	QF.DAI.03	€ 4.430	33.224
Dai sofa 03 QM PLUS	QP.DAI.S03	€ 4.864	36.478
Dai sofa 03 QM TEX	QT.DAI.03	€ 7.607	57.049
Dai sofa 03 QM CAT 1	QU1.DAI.03	€ 6.109	45.816
Dai sofa 03 QM CAT 2	QU2.DAI.03	€ 6.890	51.678
Dai sofa 03 QM CAT 0/COM	QU0.DAI.03	€ 5.769	43.266
Dai mirror QM FOAM	QF.DAI.MIR	€ 4.100	30.748
Dai mirror QM PLUS	QP.DAI.MIR	€ 4.502	33.768
Dai mirror QM TEX	QT.DAI.MIR	€ 6.514	48.858
Dai mirror QM CAT 1	QU1.DAI.MIR	€ 5.114	38.358
Dai mirror QM CAT 2	QU2.DAI.MIR	€ 5.840	43.801
Dai mirror QM CAT 0/COM	QU0.DAI.MIR	€ 4.799	35.991
Dai ottoman QM FOAM	QF.DAI.OTT	€ 630	4.728
Dai ottoman QM PLUS	QP.DAI.OTT	€ 706	5.296
Dai ottoman QM TEX	QT.DAI.OTT	€ 1.473	11.048
Dai ottoman QM CAT 1	QU1.DAI.OTT	€ 1.201	9.010

Dai ottoman QM CAT 2	QU2.DAI.OTT	€ 1.338	10.035
Dai ottoman QM CAT 0/COM	QU0.DAI.OTT	€ 1.142	8.565

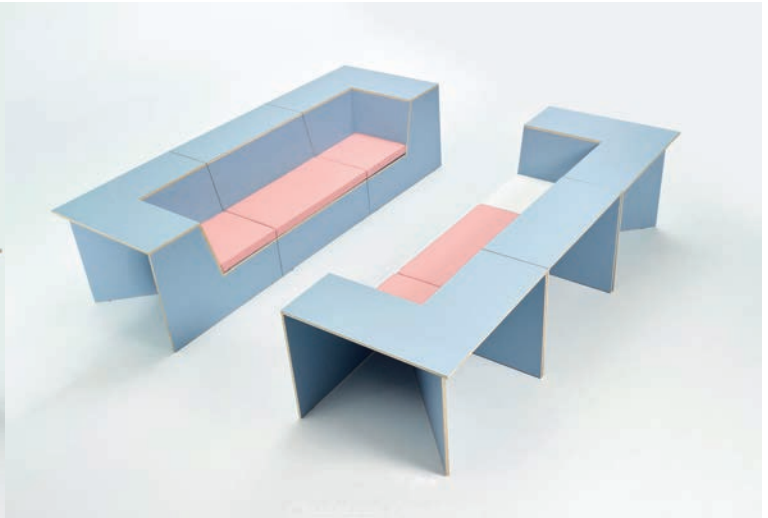

DOK furniture office system  
 Why choosing between a table or seat, when you can combine both?  
 DOK creates instant functionality where needed, in endless combinations.  
 This seating and work space makes any environment productive, valuable and inspiring.  
 Available in different materials for indoor & outdoor.  
<http://www.fiveam.be/work/dok/>

DOK CUSHIONS are also available upholstered in leather and fabric.  
 Custom color or sizes are available upon request.



DOK CORNER

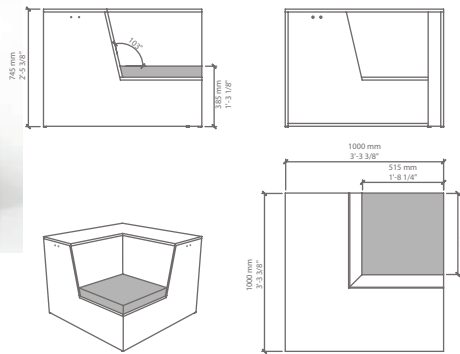

DOK IN corner Multiplex birch

DOK IN corner Polyrey Finishing

DOK STRAIGHT

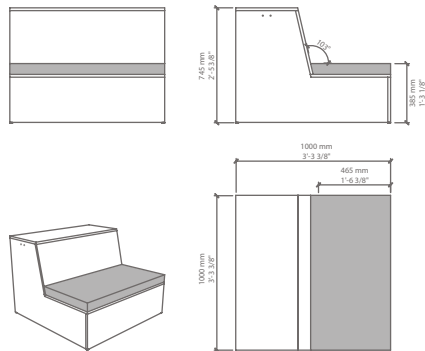

DOK IN straight Multiplex birch

DOK IN straight Polyrey Finishing

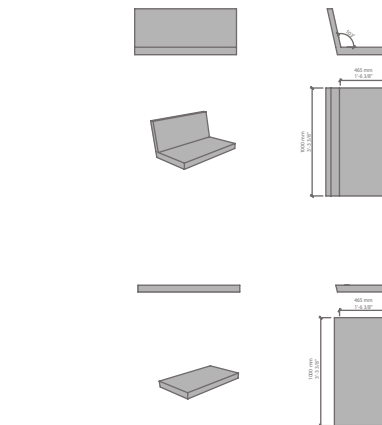

DOK Cushion straight no back QM Foam skin

DOK Cushion straight no back QM Plus foamskin double

DOK Cushion straight no back QM Tex foamskin Tex

DOK Cushion straight no back QM CAT 1

DOK Cushion straight no back QM CAT 2

DOK Cushion straight no back QM CAT 0 / COM

DOK Cushion corner no back QM Foam skin

DOK Cushion corner no back QM Plus foamskin double

DOK Cushion corner no back QM Tex foamskin Tex

DOK Cushion corner no back QM CAT 1

DOK Cushion corner no back QM CAT 2

DOK Cushion corner no back QM CAT 0 / COM

DOK Cushion straight with back QM Foam skin

DOK Cushion straight with back QM Plus foamskin double

DOK Cushion corner with back QM Foam skin

DOK Cushion corner with back QM Plus foamskin double

DOK IN corner Multiplex birch	WO.DOK.ICO	€ 1.493	11.199
DOK IN straight Multiplex birch	WO.DOK.IST	€ 1.168	8.761
DOK Cushion straight no back QM FOAM	QF.DOK.S	€ 416	3.120
DOK Cushion straight no back QM PLUS	QP.DOK.S	€ 482	3.612
DOK Cushion straight no back QM TEX	QT.DOK.S	€ 700	5.249
DOK Cushion straight no back QM CAT 1	QU1.DOK.S	€ 447	3.354
DOK Cushion straight no back QM CAT 2	QU2.DOK.S	€ 559	4.189
DOK Cushion straight no back QM CAT 0 / COM	QU0.DOK.S	€ 392	2.937
DOK Cushion corner no back QM FOAM	QF.DOK.C	€ 262	1.962
DOK Cushion corner no back QM PLUS	QP.DOK.C	€ 297	2.227
DOK Cushion corner no back QM TEX	QT.DOK.C	€ 424	3.176
DOK Cushion corner no back QM CAT 1	QU1.DOK.C	€ 289	2.169
DOK Cushion corner no back QM CAT 2	QU2.DOK.C	€ 357	2.675
DOK Cushion corner no back QM CAT 0 / COM	QU0.DOK.C	€ 257	1.929
DOK Cushion straight with back QM FOAM	QF.DOK.SBA	€ 800	5.997
DOK Cushion straight with back QM PLUS	QP.DOK.SBA	€ 905	6.786
DOK Cushion corner with back QM FOAM	QF.DOK.CBA	€ 671	5.029
DOK Cushion corner with back QM PLUS	QP.DOK.CBA	€ 749	5.614



0 = product price in calculation - contact our office for pricing

# DEER

## DESIGN SAQ

### 2005



*Quinze & milan*

An informal waiting system, inspired by the forms of nature.

Three modules with different geometric forms can be composed in countless ways and form islands of seats designed for large public spaces and of a destructured home.

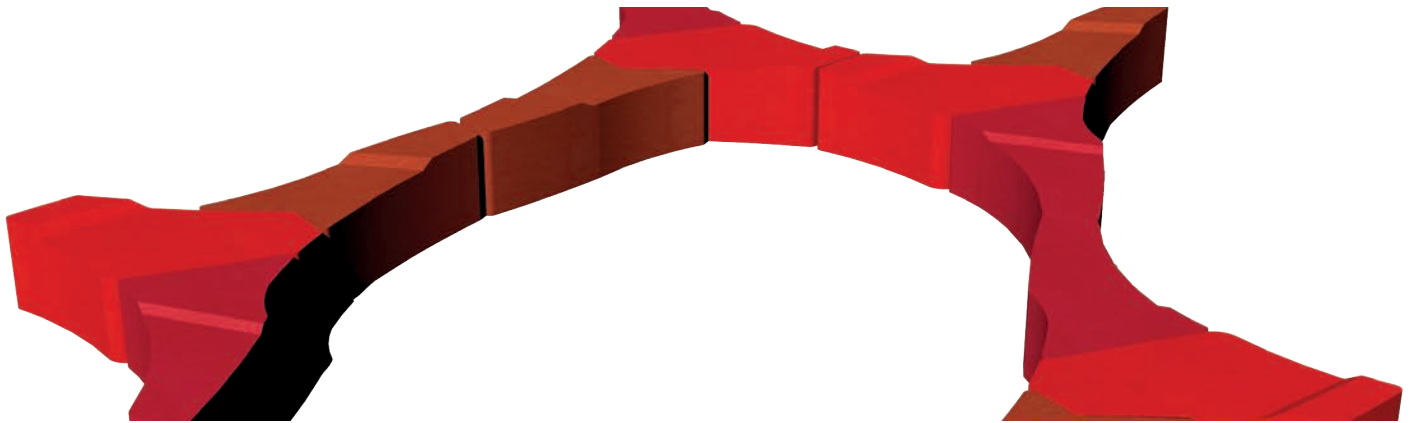

DEER 01

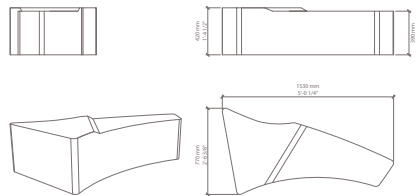

DEER 02

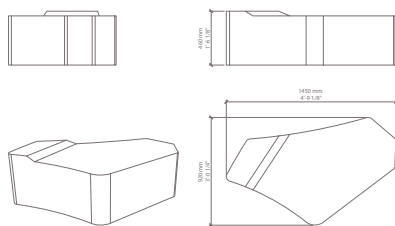

DEER 03

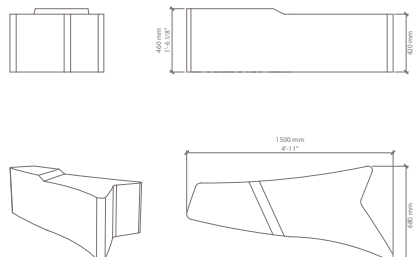

- .....
- Deer Set QM Foam skin
- .....
- Deer Set QM Plus foamskin double
- .....
- Deer Set QM CAT 1
- .....
- Deer Set QM CAT 2
- .....
- Deer Set QM CAT 0/COM
- .....

- .....
- Deer 1 QM Foam skin
- .....
- Deer 1 QM Plus foamskin double
- .....
- Deer 1 QM CAT 1
- .....
- Deer 1 QM CAT 2
- .....
- Deer 1 QM CAT 0/COM
- .....

- .....
- Deer 2 QM Foam skin
- .....
- Deer 2 QM Plus foamskin double
- .....
- Deer 2 QM CAT 1
- .....
- Deer 2 QM CAT 2
- .....
- Deer 2 QM CAT 0/COM
- .....

- .....
- Deer 3 QM Foam skin
- .....
- Deer 3 QM Plus foamskin double
- .....
- Deer 3 QM CAT 1
- .....
- Deer 3 QM CAT 2
- .....
- Deer 3 QM CAT 0/COM
- .....

0 = product price in calculation - contact our office for pricing

Deer Set QM FOAM	QF.DEE.SET	€ 5.472	41.043
Deer Set QM PLUS	QP.DEE.SET	€ 6.047	45.353
Deer Set QM CAT 1	QU1.DEE.SET	€ 7.537	56.526
Deer Set QM CAT 2	QU2.DEE.SET	€ 8.572	64.293
Deer Set QM CAT 0/COM	QU0.DEE.SET	€ 7.731	57.982
Deer 1 QM FOAM	QF.DEE.01	€ 1.651	12.384
Deer 1 QM PLUS	QP.DEE.01	€ 1.802	13.518
Deer 1 QM CAT 1	QU1.DEE.01	€ 2.443	18.321
Deer 1 QM CAT 2	QU2.DEE.01	€ 2.715	20.362
Deer 1 QM CAT 0/COM	QU0.DEE.01	€ 2.535	19.016
Deer 2 QM FOAM	QF.DEE.02	€ 1.832	13.741
Deer 2 QM PLUS	QP.DEE.02	€ 2.008	15.059
Deer 2 QM CAT 1	QU1.DEE.02	€ 2.485	18.638
Deer 2 QM CAT 2	QU2.DEE.02	€ 2.802	21.012
Deer 2 QM CAT 0/COM	QU0.DEE.02	€ 2.561	19.205
Deer 3 QM FOAM	QF.DEE.03	€ 1.989	14.917
Deer 3 QM PLUS	QP.DEE.03	€ 2.237	16.776
Deer 3 QM CAT 1	QU1.DEE.03	€ 2.609	19.569
Deer 3 QM CAT 2	QU2.DEE.03	€ 3.055	22.916
Deer 3 QM CAT 0 / COM	QU0.DEE.03	€ 2.635	19.760





0 = product price in calculation - contact our office for pricing

# GALETTE

## DESIGN SDC lab

### 2016



#### GALETTE

a simple square, rectangular or round cushion with a minimum thickness of 6cm, provides the ideal color swatch for your projects.

Contact our sales office for more pricing options.

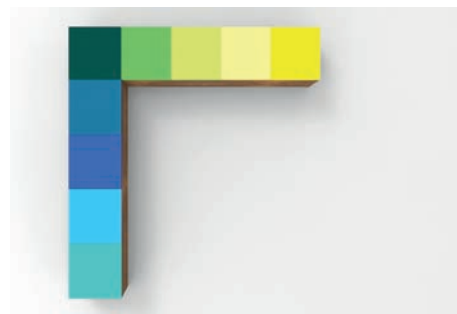

#### GALETTE ROUND

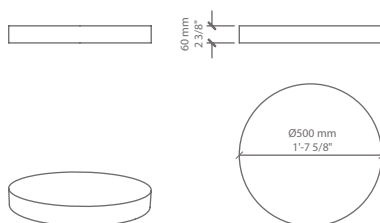

- .....
- Galettes - round diam 50cm x H6cm - QM Foam skin
- .....
- Galettes - round diam 50cm x H6cm - QM Plus foamskin double
- .....
- Galettes - round diam 50cm x H6cm - QM Tex foamskin Tex
- .....
- Galettes - round diam 50cm x H6cm - fabric CAT 1
- .....
- Galettes - round diam 50cm x H6cm - fabric CAT 2
- .....
- Galettes - round diam 50cm x H6cm - fabric CAT 0/COM
- .....

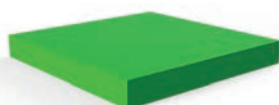

#### GALETTE SQUARE

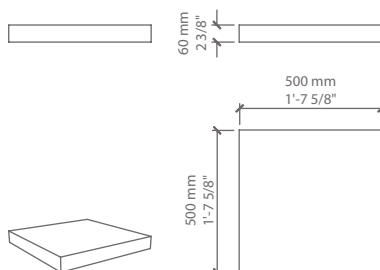

- .....
- Galettes - square 50cm x H6cm - QM Foam skin
- .....
- Galettes - square 50cm x H6cm - QM Plus foamskin double
- .....
- Galettes - square 50cm x H6cm - QM Tex foamskin Tex
- .....
- Galettes - square 50cm x H6cm - fabric CAT 1
- .....
- Galettes - square 50cm x H6cm - fabric CAT 2
- .....
- Galettes - square 50cm x H6cm - fabric CAT 0/COM
- .....

0 = product price in calculation - contact our office for pricing

Galettes - square 50cm x H6cm - foamskin	QF.GAL.SQU	€ 232	1.741
Galettes - square 50cm x H6cm - foamskin double	QP.GAL.SQU	€ 272	2.040
Galettes - square 50cm x H6cm - foamskin tex	QT.GAL.SQU	€ 355	2.666
Galettes - square 50cm x H6cm - fabric CAT 1	QU1.GAL.SQU	€ 219	1.644
Galettes - square 50cm x H6cm - fabric CAT 2	QU2.GAL.SQU	€ 278	2.087
Galettes - square 50cm x H6cm - fabric CAT 0/COM	QU0.GAL.SQU	€ 194	1.452
Galettes - round diam 50cm x H6cm - foamskin	QF.GAL.ROU	€ 242	1.817
Galettes - round diam 50cm x H6cm - foamskin double	QP.GAL.ROU	€ 282	2.116
Galettes - round diam 50cm x H6cm - foamskin tex	QT.GAL.ROU	€ 382	2.868
Galettes - round diam 50cm x H6cm - fabric CAT 1	QU1.GAL.ROU	€ 219	1.644
Galettes - round diam 50cm x H6cm - fabric CAT 2	QU2.GAL.ROU	€ 278	2.087
Galettes - round diam 50cm x H6cm - fabric CAT 0/COM	QU0.GAL.ROU	€ 194	1.452

GAP

DESIGN Kazuko Okamoto

2018



✓ product price in consultation | contact our service for pricing



GAP SEAT

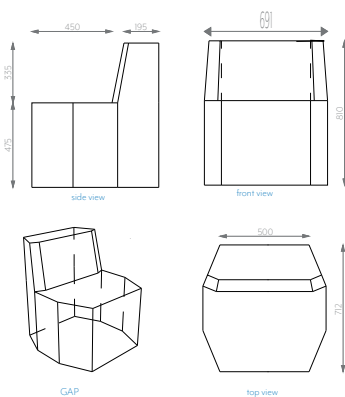

- GAP - seat - QM Foam skin
- GAP - seat - QM Plus foamskin double

GAP POUF

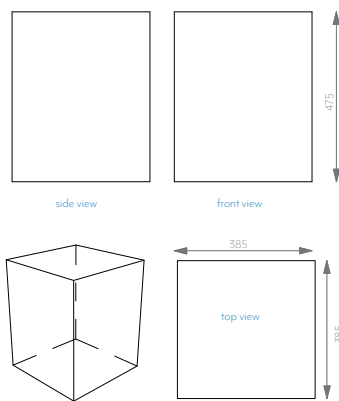

- GAP - pouf - QM Foam skin
- GAP - pouf - QM Plus foamskin double

GAP TRIANGLE

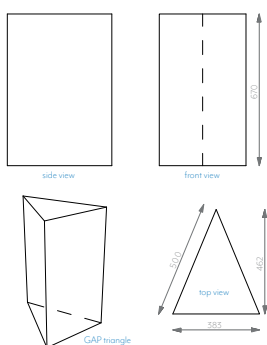

- Gap Triangle pouf QM Foam skin
- Gap Triangle pouf QM Plus foamskin double

0 = product price in calculation - contact our office for pricing



GAP

DESIGN Kazuko Okamoto

2018

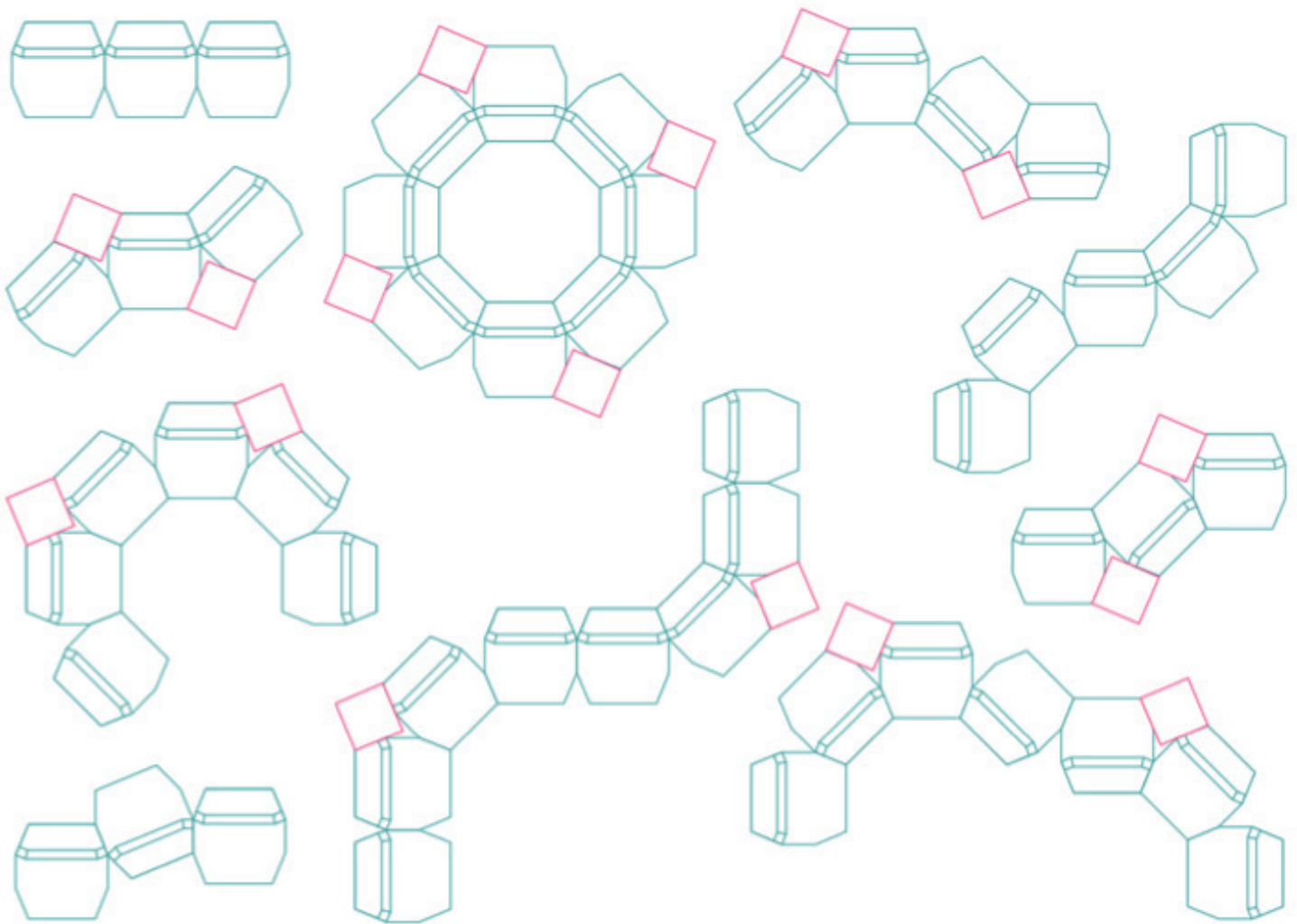
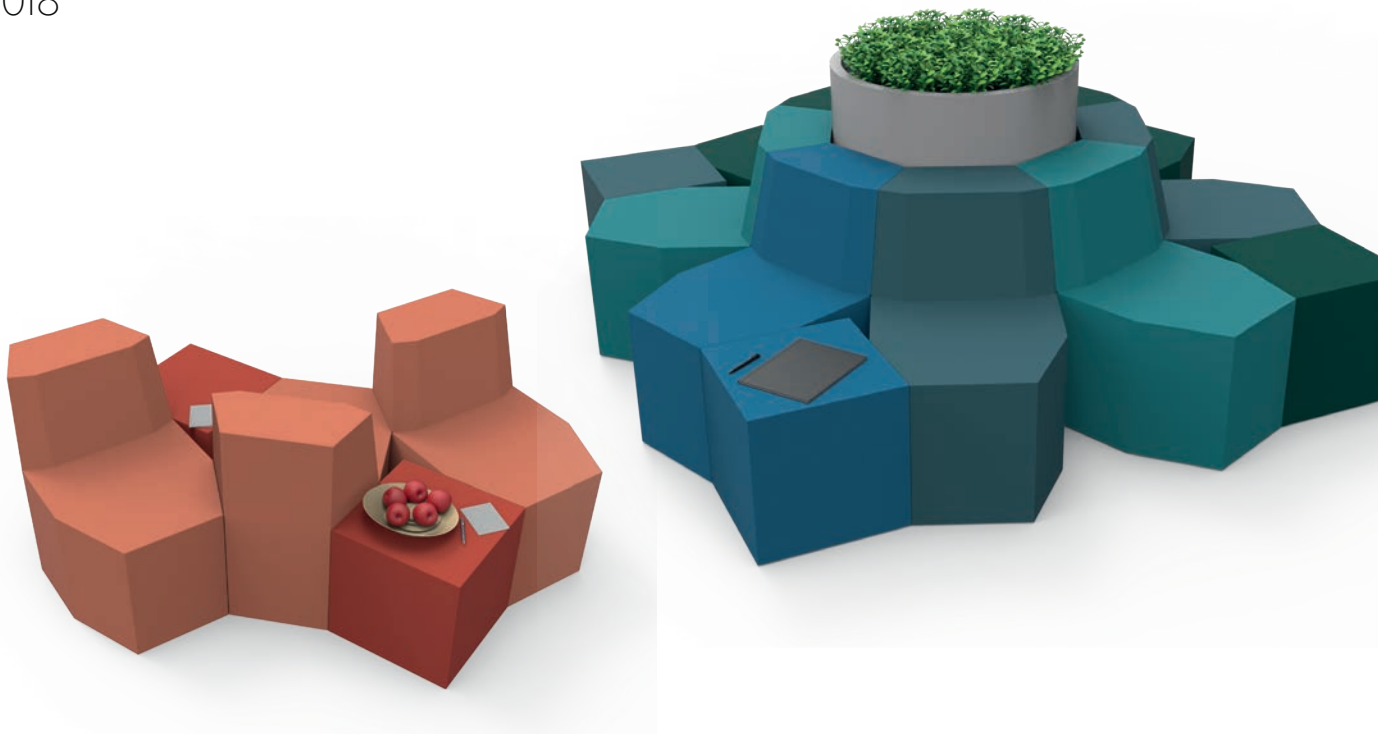

0 = product price in calculation - contact our office for pricing

GAP - seat - QM Foam	QF.GAP.SEA.	€ 1.395	10.465
GAP - seat - QM Plus	QP.GAP.SEA.	€ 1.529	11.467
GAP - seat - QM Tex	QT.GAP.SEA.	€ 2.314	17.353
GAP - seat - fabric CAT 0/COM	QU0.GAP.SEA.	€ 0	0
GAP - seat - fabric CAT 1	QU1.GAP.SEA.	€ 1.938	14.536
GAP - seat - fabric CAT 2	QU2.GAP.SEA.	€ 2.292	17.192
GAP - pouf - QM Foam	QF.GAP.POU.	€ 381	2.860
GAP - pouf - QM Plus	QP.GAP.POU.	€ 434	3.258
GAP - pouf - QM Tex	QT.GAP.POU.	€ 869	6.518
GAP - pouf - fabric CAT 0/COM	QU0.GAP.POU.	€ 0	0
GAP - pouf - fabric CAT 1	QU1.GAP.POU.	€ 723	5.425
GAP - pouf - fabric CAT 2	QU2.GAP.POU.	€ 863	6.472



# FRAME

DESIGN QUINZE & MILAN

2004



*Quinze & milan*



0 = product price in calculation - contact our office for pricing

# FRAME

## DESIGN QUINZE & MILAN

2004



**Quinze & milan**

Part of moving forward is looking backward. FRAME is a 21st-century remake of the old-fashioned armchair.

Familiar and fascinating at the same time, FRAME combines a stationary tubular-metal frame with Foamskin or upholstered in leather or fabric all for matchless comfort.

Its fresh, distinctive look complements any contemporary setting, while blending with equal ease into a more classic environment. FRAME includes one and two seater settees with and without armrests.



FRAME ARM 75

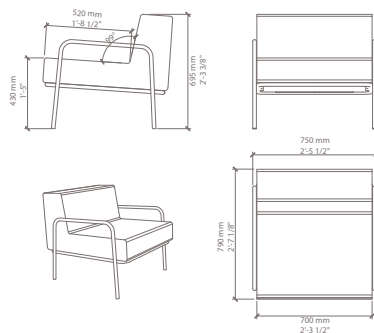

- .....
- .....
- .....
- .....
- .....
- .....
- .....
- .....
- .....
- .....

FRAME ARM 100

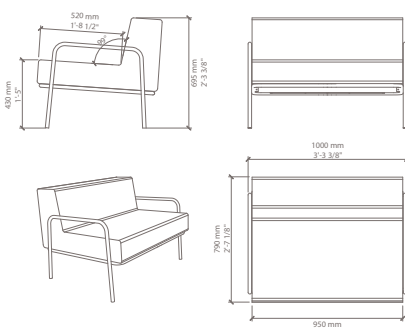

- .....
- .....
- .....
- .....
- .....
- .....
- .....
- .....
- .....
- .....

FRAME 100

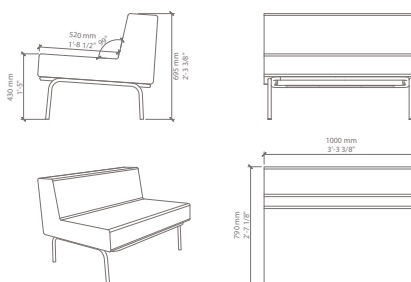

- .....
- .....
- .....
- .....
- .....
- .....
- .....
- .....
- .....
- .....

0 = product price in calculation - contact our office for pricing

Frame ARM 75 QM FOAM	QF.FRA.ARM.75	€ 1.489	11.170
Frame ARM 75 QM PLUS	QP.FRA.ARM.75	€ 1.600	12.003
Frame ARM 75 QM CAT 1	QU1.FRA.ARM.75	€ 2.239	16.792
Frame ARM 75 QM CAT 2	QU2.FRA.ARM.75	€ 2.436	18.268
Frame ARM 75 QM CAT 0	QU0.FRA.ARM.75	€ 2.154	16.152
Frame ARM 100 QM FOAM	QF.FRA.ARM.100	€ 1.742	13.066
Frame ARM 100 QM PLUS	QP.FRA.ARM.100	€ 1.889	14.166
Frame ARM 100 QM CAT 1	QU1.FRA.ARM.100	€ 2.305	17.286
Frame ARM 100 QM CAT 2	QU2.FRA.ARM.100	€ 2.570	19.277
Frame ARM 100 QM CAT 0	QU0.FRA.ARM.100	€ 2.189	16.420
Frame 100 QM FOAM	QF.FRA.100	€ 1.742	13.066
Frame 100 QM PLUS	QP.FRA.100	€ 1.889	14.166
Frame 100 QM CAT 1	QU1.FRA.100	€ 2.305	17.286
Frame 100 QM CAT 2	QU2.FRA.100	€ 2.143	16.070
Frame 100 QM CAT 0	QU0.FRA.100	€ 2.189	16.420



0 = product price in calculation - contact our office for pricing

A collection of seating elements that can be combined into... that's right... INFINITY. These pieces are perfect for large public spaces – lounges, lobbies, waiting rooms – or for any spot that will benefit from being divided and subdivided ad infinitum. Those who live in less spacious quarters can stack INFINITY modules to make partition walls. The possibilities are infinite.

INFINITY is also available upholstered in leather and fabric.  
Custom color or sizes are available upon request.



INFINITY STRAIGHT S

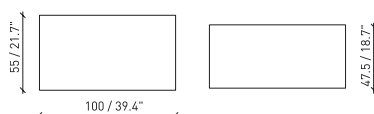

- ..... Infinity Straight S QM Foam skin
- ..... Infinity Straight S QM Plus foamskin double
- ..... Infinity Straight S QM Tex foamskin Tex
- ..... Infinity Straight S QM CAT 1
- ..... Infinity Straight S QM CAT 2
- ..... Infinity Straight S QM CAT 0/COM



INFINITY STRAIGHT L

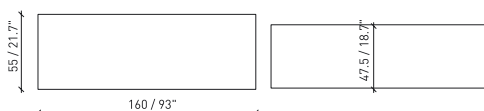

- ..... Infinity Straight L QM Foam skin
- ..... Infinity Straight L QM Plus foamskin double
- ..... Infinity Straight L QM Tex foamskin Tex
- ..... Infinity Straight L QM CAT 1
- ..... Infinity Straight L QM CAT 2
- ..... Infinity Straight L QM CAT 0/COM



INFINITY STRAIGHT XL

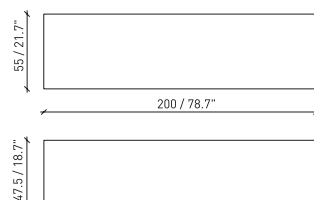

- ..... Infinity Straight XL QM Foam skin
- ..... Infinity Straight XL QM Plus foamskin double
- ..... Infinity Straight XL QM Tex foamskin Tex
- ..... Infinity Straight XL QM CAT 1
- ..... Infinity Straight XL QM CAT 2
- ..... Infinity Straight XL QM CAT 0/COM

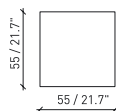

- ..... Infinity Cube S QM Foam skin
- ..... Infinity Cube S QM Plus foamskin double
- ..... Infinity Cube S QM Tex foamskin Tex
- ..... Infinity Cube S QM CAT 1
- ..... Infinity Cube S QM CAT 2
- ..... Infinity Cube S QM CAT 0/COM



INFINITY CUBE XL

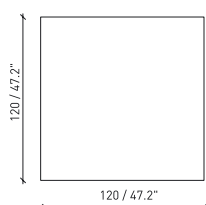

- ..... Infinity Cube XL QM Foam skin
- ..... Infinity Cube XL QM Plus foamskin double
- ..... Infinity Cube XL QM Tex foamskin Tex
- ..... Infinity Cube XL QM CAT 1
- ..... Infinity Cube XL QM CAT 2
- ..... Infinity Cube XL QM CAT 0/COM

0 = product price in calculation - contact our office for pricing



# INFINITY DESIGN SAQ 2000



**Quinze & milan**

## INFINITY

Infinity allows you to play with basic shapes. Besides the most common straight version, the following connection pieces offers you to create a versatile and dynamic setting.

Contact our sales office for more pricing options.



### INFINITY CORNER

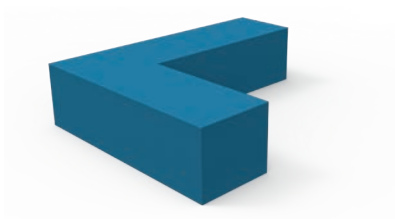

Infinity corner QM FOAM

### INFINITY L-SEAT



Infinity L-seat QM FOAM

### INFINITY Z-SEAT

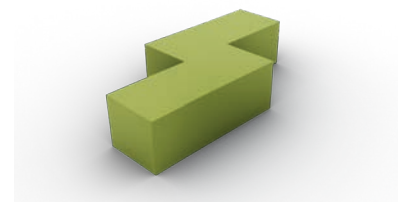

Infinity Z-seat QM FOAM

All pricing in other finishings, such as QM Plus, QM Upholstering is available. Please check our sales office for detailed prices and send us your needs, so we can provide you with the right quote

### INFINITY CURVE S



Infinity curve S QM FOAM

### INFINITY CURVE M



Infinity curve M QM FOAM

### INFINITY CURVE L



Infinity curve L QM FOAM

All pricing in other finishings, such as QM Plus, QM Upholstering is available. Please check our sales office for detailed prices and send us your needs, so we can provide you with the right quote

### INFINITY CURVE XL



Infinity curve XL QM FOAM

#### CHOOSE YOUR TOPVIEW:

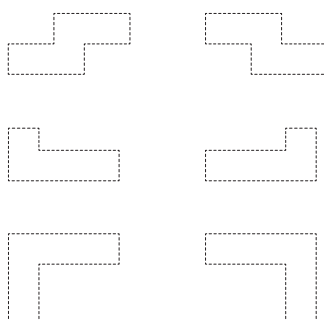

#### IMPORTANT / QM AIR VENT

Upon ordering, please mention on which side Air Vents have to be integrated.

By allowing the QM FOAM to breathe the inside pressure remains controlled, which gives enhanced seating comfort throughout the cushion. Aerating PU foam extends its flexibility, reduces the stress on the individual cells which therefore keep their elasticity much longer. This keeps the foam from wrinkling or loosing its shape.

0 = product price in calculation - contact our office for pricing

Infinity Straight S QM FOAM	QF.INF.STS	€ 911	6.833
Infinity Straight S QM PLUS	QP.INF.STS	€ 1.043	7.823
Infinity Straight S QM TEX	QT.INF.STS	€ 1.655	12.409
Infinity Straight S QM CAT 1	QU1.INF.STS	€ 1.163	8.725
Infinity Straight S QM CAT 2	QU2.INF.STS	€ 1.416	10.620
Infinity Straight S QM CAT 0/COM	QU0.INF.STS	€ 1.053	7.899
Infinity Straight L QM FOAM	QF.INF.STL	€ 1.381	10.360
Infinity Straight L QM PLUS	QP.INF.STL	€ 1.576	11.823
Infinity Straight L QM TEX	QT.INF.STL	€ 2.236	16.769
Infinity Straight L QM CAT 1	QU1.INF.STL	€ 1.531	11.480
Infinity Straight L QM CAT 2	QU2.INF.STL	€ 1.904	14.282
Infinity Straight L QM CAT 0/COM	QU0.INF.STL	€ 1.368	10.260
Infinity Straight XL QM FOAM	QF.INF.SXL	€ 1.670	12.527
Infinity Straight XL QM PLUS	QP.INF.SXL	€ 1.907	14.304
Infinity Straight XL QM TEX	QT.INF.SXL	€ 2.697	20.225
Infinity Straight XL QM CAT 1	QU1.INF.SXL	€ 1.839	13.792
Infinity Straight XL QM CAT 2	QU2.INF.SXL	€ 2.293	17.199
Infinity Straight XL QM CAT 0/COM	QU0.INF.SXL	€ 1.641	12.311
Infinity Cube S QM FOAM	QF.INF.CUS	€ 548	4.109
Infinity Cube S QM PLUS	QP.INF.CUS	€ 632	4.743
Infinity Cube S QM TEX	QT.INF.CUS	€ 991	7.434
Infinity Cube S QM CAT 1	QU1.INF.CUS	€ 683	5.122
Infinity Cube S QM CAT 2	QU2.INF.CUS	€ 845	6.338
Infinity Cube S QM CAT 0/COM	QU0.INF.CUS	€ 612	4.592
Infinity Cube XL QM FOAM	QF.INF.CXL	€ 1.982	14.867
Infinity Cube XL QM PLUS	QP.INF.CXL	€ 2.247	16.852
Infinity Cube XL QM TEX	QT.INF.CXL	€ 2.813	21.094
Infinity Cube XL QM CAT 1	QU1.INF.CXL	€ 1.855	13.914
Infinity Cube XL QM CAT 2	QU2.INF.CXL	€ 2.363	17.720
Infinity Cube XL QM CAT 0/COM	QU0.INF.CXL	€ 1.635	12.260
Infinity Z-seat QM FOAM	QF.INF.ZSE	€ 2.772	20.789
Infinity Z-seat QM PLUS	QP.INF.ZSE	€ 3.088	23.159
Infinity Z-seat QM TEX	QT.INF.ZSE	€ 4.009	30.071
Infinity Z-seat QM CAT 1	QU1.INF.ZSE	€ 3.128	23.461
Infinity Z-seat QM CAT 2	QU2.INF.ZSE	€ 3.738	28.033
Infinity Z-seat QM CAT 0/COM	QU0.INF.ZSE	€ 2.863	21.471
Infinity L-seat QM FOAM	QF.INF.LSE	€ 2.677	20.078
Infinity L-seat QM PLUS	QP.INF.LSE	€ 2.956	22.170
Infinity L-seat QM TEX	QT.INF.LSE	€ 3.319	24.893
Infinity L-seat QM CAT 1	QU1.INF.LSE	€ 2.304	17.281



Infinity L-seat QM CAT 2	QU2.INF.LSE	€ 2.839	21.294
Infinity L-seat QM CAT 0/COM	QU0.INF.LSE	€ 2.072	15.536
Infinity corner QM FOAM	QF.INF.COR	€ 3.113	23.345
Infinity corner QM PLUS	QP.INF.COR	€ 3.460	25.949
Infinity corner QM TEX	QT.INF.COR	€ 4.152	31.142
Infinity corner QM CAT 1	QU1.INF.COR	€ 2.848	21.363
Infinity corner QM CAT 2	QU2.INF.COR	€ 3.537	26.526
Infinity corner QM CAT 0/COM	QU0.INF.COR	€ 2.549	19.119
Infinity curve S QM FOAM	QF.INF.CURS	€ 885	6.636
Infinity curve S QM PLUS	QP.INF.CURS	€ 980	7.347
Infinity curve S QM TEX	QT.INF.CURS	€ 1.344	10.077
Infinity curve S QM CAT 1	QU1.INF.CURS	€ 1.057	7.928
Infinity curve S QM CAT 2	QU2.INF.CURS	€ 1.254	9.404
Infinity curve S QM CAT 0/COM	QU0.INF.CURS	€ 972	7.287
Infinity curve M QM FOAM	QF.INF.CURM	€ 1.613	12.097
Infinity curve M QM PLUS	QP.INF.CURM	€ 1.776	13.320
Infinity curve M QM TEX	QT.INF.CURM	€ 2.897	21.731
Infinity curve M QM CAT 1	QU1.INF.CURM	€ 2.476	18.573
Infinity curve M QM CAT 2	QU2.INF.CURM	€ 2.821	21.156
Infinity curve M QM CAT 0/COM	QU0.INF.CURM	€ 2.327	17.451
Infinity curve L QM FOAM	QF.INF.CURL	€ 3.148	23.610
Infinity curve L QM PLUS	QP.INF.CURL	€ 3.447	25.853
Infinity curve L QM TEX	QT.INF.CURL	€ 4.637	34.779
Infinity curve L QM CAT 1	QU1.INF.CURL	€ 3.870	29.027
Infinity curve L QM CAT 2	QU2.INF.CURL	€ 4.460	33.452
Infinity curve L QM CAT 0/COM	QU0.INF.CURL	€ 3.614	27.103
Infinity curve XL QM FOAM	QF.INF.CURXL	€ 4.553	34.147
Infinity curve XL QM PLUS	QP.INF.CURXL	€ 4.989	37.414
Infinity curve XL QM TEX	QT.INF.CURXL	€ 6.500	48.749
Infinity curve XL QM CAT 1	QU1.INF.CURXL	€ 5.830	43.725
Infinity curve XL QM CAT 2	QU2.INF.CURXL	€ 6.341	47.560
Infinity curve XL QM CAT 0/COM	QU0.INF.CURXL	€ 5.608	42.057

# LEAF bench

DESIGN Kazuko Okamoto

2018

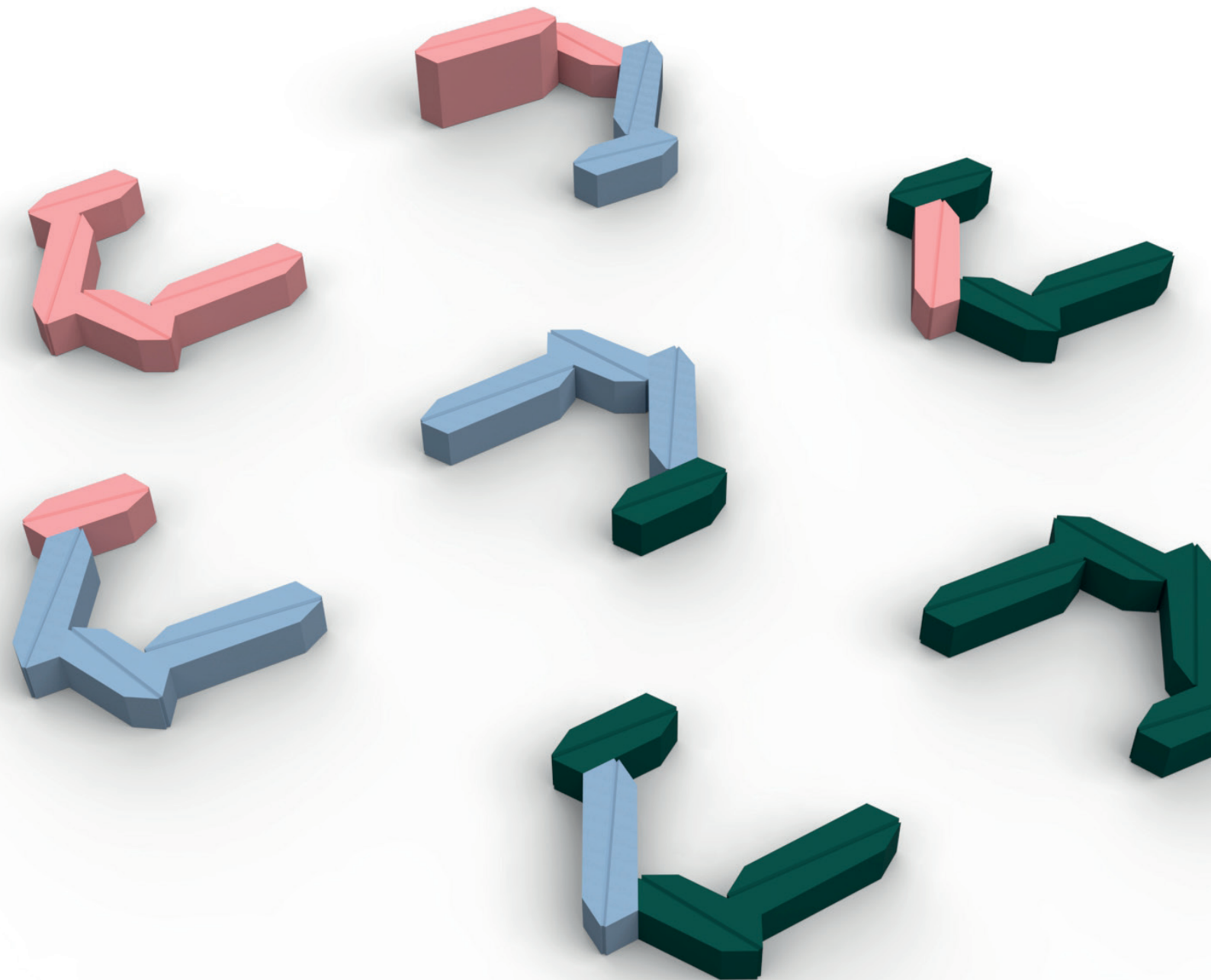

0 = product price in calculation - contact our office for pricing

# LEAF bench

DESIGN Kazuko Okamoto

2018

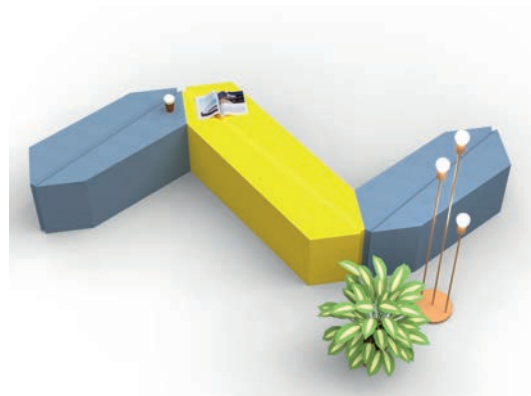

## LEAF BENCH SMALL

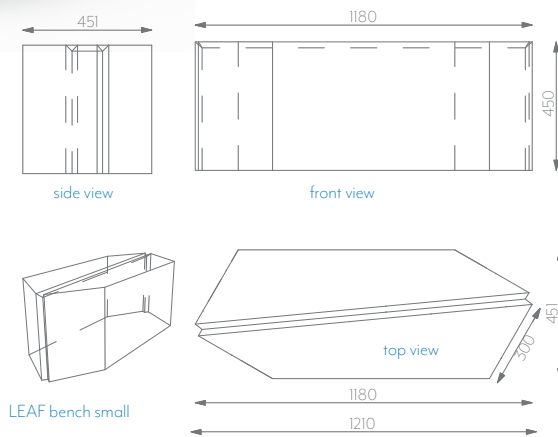
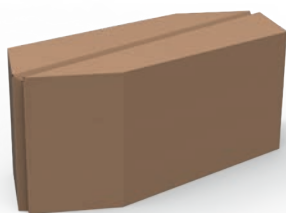

LEAF bench small

LEAF - small - QM Foam skin

LEAF - small - QM Plus foamskin double

## LEAF BENCH LARGE

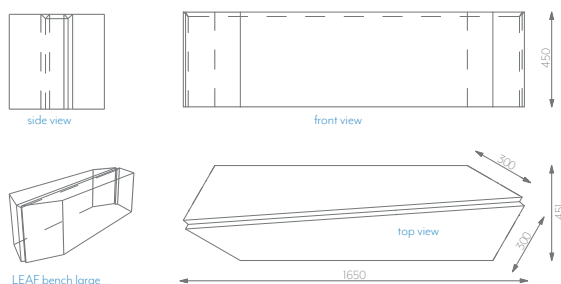
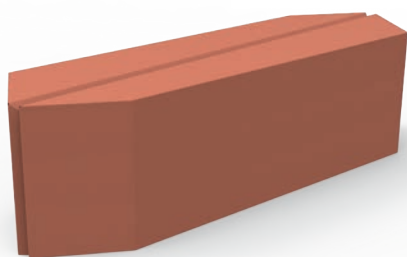

LEAF bench large

LEAF - large - QM Foam skin

LEAF - large - QM Plus foamskin double

0 = product price in calculation - contact our office for pricing



# LEAF bench

DESIGN Kazuko Okamoto

2018

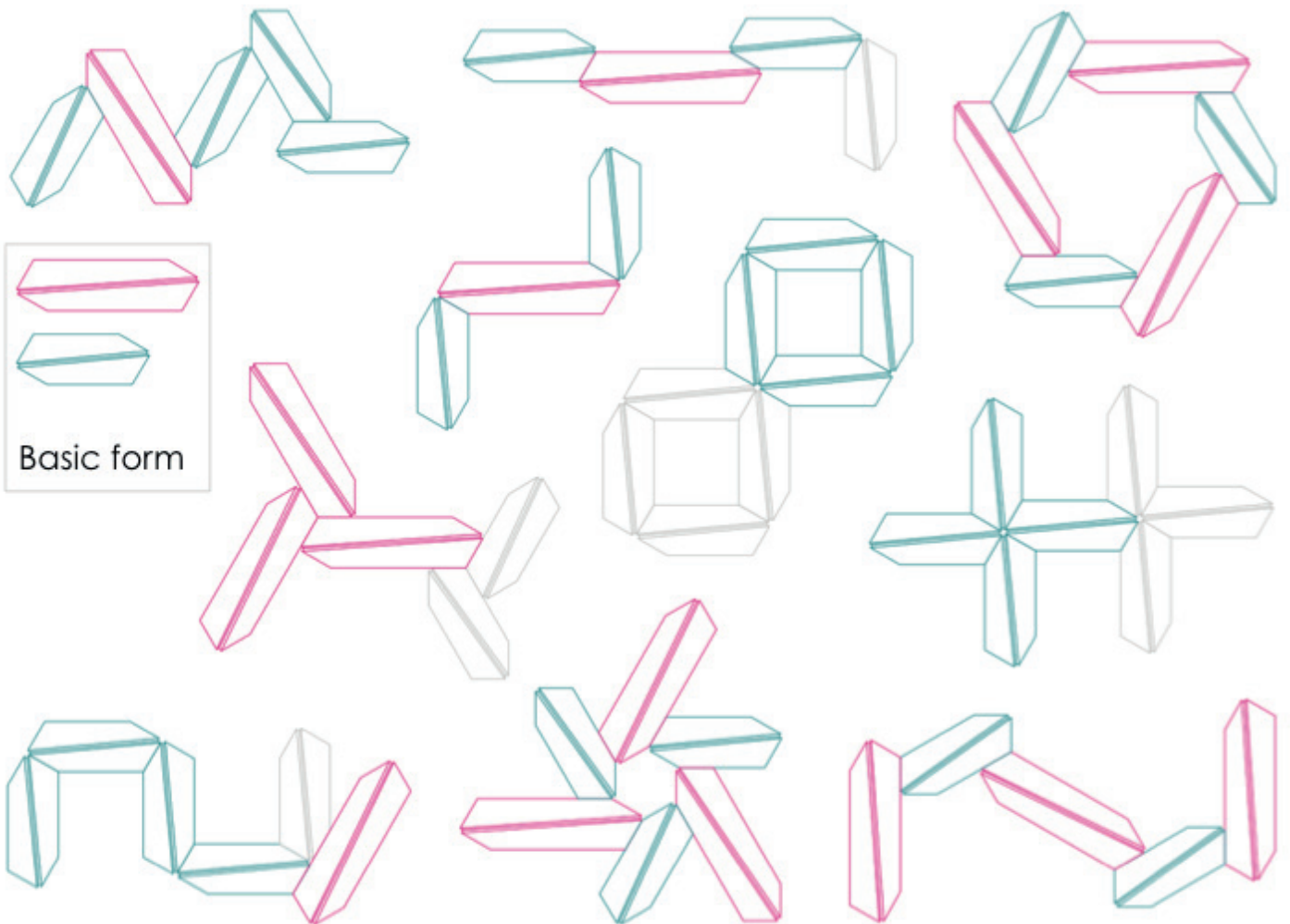
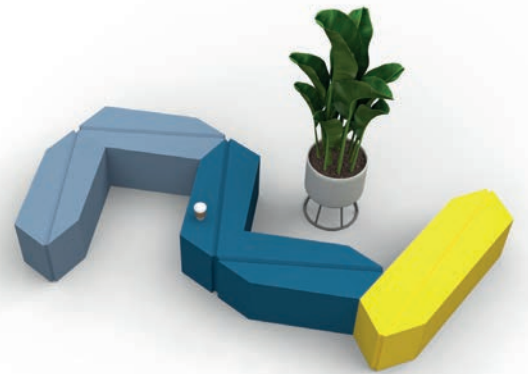
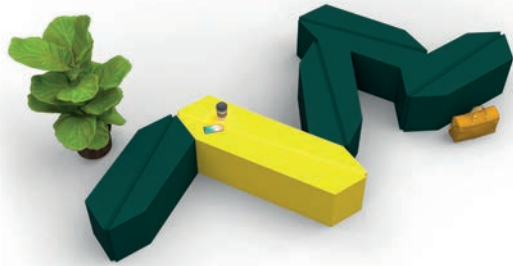

0 = product price in calculation - contact our office for pricing

LEAF - small - QM Foam	QF.LEA.SMA.	€ 1.157	8.676
LEAF - small - QM Plus	QP.LEA.SMA.	€ 1.263	9.474
LEAF - small - QM Tex	QT.LEA.SMA.	€ 0	0
LEAF - small - fabric CAT 0/COM	QU0.LEA.SMA.	€ 0	0
LEAF - small - fabric CAT 1	QU1.LEA.SMA.	€ 0	0
LEAF - small - fabric CAT 2	QU2.LEA.SMA.	€ 0	0
LEAF - large - QM Foam	QF.LEA.LAR.	€ 1.476	11.072
LEAF - large - QM Plus	QP.LEA.LAR.	€ 1.621	12.161
LEAF - large - QM Tex	QT.LEA.LAR.	€ 0	0
LEAF - large - fabric CAT 0/COM	QU0.LEA.LAR.	€ 0	0
LEAF - large - fabric CAT 1	QU1.LEA.LAR.	€ 0	0
LEAF - large - fabric CAT 2	QU2.LEA.LAR.	€ 0	0



0 = product price in calculation - contact our office for pricing

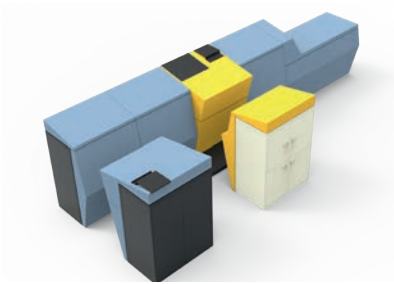

LEAN is multifunctional furniture system that responds to the needs of a contemporary workday-life, stimulating both body and mind, while overlaying different functions in the office environment. With the aim to avoid sitting for long periods of time while working, this modular furniture arrangement provides a dynamic exchange between sitting, standing and leaning to encourage movement and posture change as well as provide social interaction.

By developing versatile ergonomic uses, the system allows comfortable standing or elevated seating. The designs are ideal for leaning and lounging, and the furniture invites people to move out of the static sitting routine during temporary working, relaxing, phoning, meeting and communicating.



LEAN MODULE B

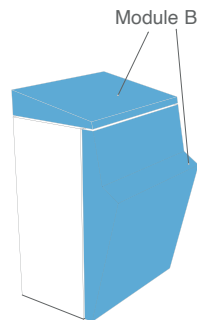

Development of this product is still in progress.  
Discover some of our pricing options for existing models  
for more information contact our sales office

Lean - foam module A - QM Foam skin

Lean foam module A - QM Plus foamskin double

Lean - foam module B - QM Foam skin

Lean foam module B - QM Plus foamskin double

Lean - foam module C - QM Foam skin

Lean foam module C - QM Plus foamskin double

Lean - foam module D - QM Foam skin

Lean foam module D - QM Plus foamskin double

Lean - foam module E - QM Foam skin

Lean foam module E - QM Plus foamskin double

The pricing is for the foam module only.

Pricing for cupboard system is depending on the chosen storage units.

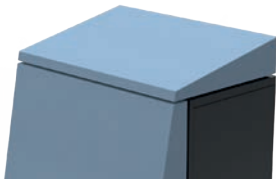

LEAN MODULE C

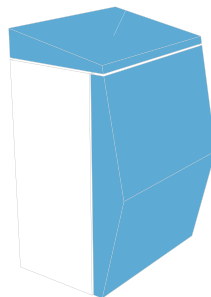

LEAN MODULE E

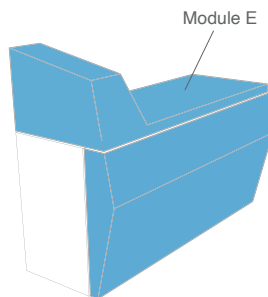



Lean - foam module A - QM Foam	QF.LEA.A.	€ 1.430	10.725
Lean - foam module B - QM Foam	QF.LEA.B.	€ 1.313	9.848
Lean - foam module C - QM Foam	QF.LEA.C.	€ 1.225	9.189
Lean - foam module E - QM Foam	QF.LEA.D.	€ 1.899	14.242
Lean - foam module D - QM Foam	QF.LEA.E.	€ 1.381	10.360
Lean - power integration - ACC	ACC.LEA.POW.	€ 729	5.469
Lean - coffee pad - Metal powdercoated	MET.LEA.COF.	€ 210	1.577
Lean - writing pad - Metal powdercoated	MET.LEA.WRI.	€ 211	1.583
Lean - footrest - Wood	WOO.LEA.FOO.	€ 1.688	12.663

LITTLE MISS O  
DESIGN CONCRETE AMSTERDAM



*Quinze & milan*



0 = product price in calculation - contact our office for pricing

# LITTLE MISS O

## DESIGN CONCRETE AMSTERDAM



**Quinze & milan**

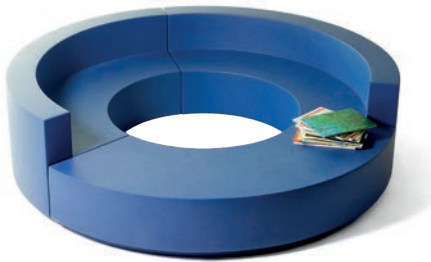

When UN Studio asked them to design certain areas for their major project, the Mercedes Benz Museum in Stuttgart, Germany, CONCRETE AMSTERDAM based all its designwork, down to the very detail on the specific identity of the owner. Their aim was to create identity within a total space experience: create individual worlds where a single visitor identifies with and which invites him to stay. The dishes, table linen and silverware in the restaurant as well as the division of the spaces are all in a way renditions of the three-pointed Mercedes Benz logo. LITTLE MISS O, which is placed in the children island, is a result from that research and provides an ideal playground where to nurse children and play with them.

Custom color or sizes are available upon request.

### LITTLE MISS O SMALL

\*DELIVERY KNOCK DOWN IN THREE PIECES

#### LITTLE MISS O SMALL COMPLETE

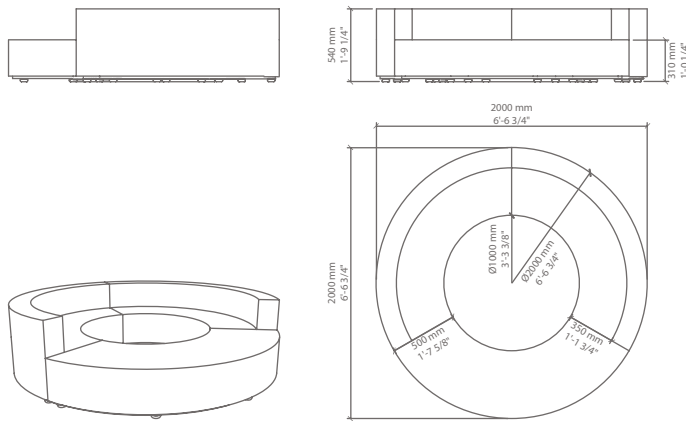

- ..... Little Miss O small complete (no floor) QM Foam skin
- ..... Little Miss O small complete (no floor) QM Plus foamskin double
- ..... Little Miss O small complete (no floor) QM Tex foamskin Tex
- ..... Little Miss O small complete (no floor) QM CAT 1
- ..... Little Miss O small complete (no floor) QM CAT 2
- ..... Little Miss O small complete (no floor) QM CAT 0/COM

#### LITTLE MISS O SMALL - bench with backrest

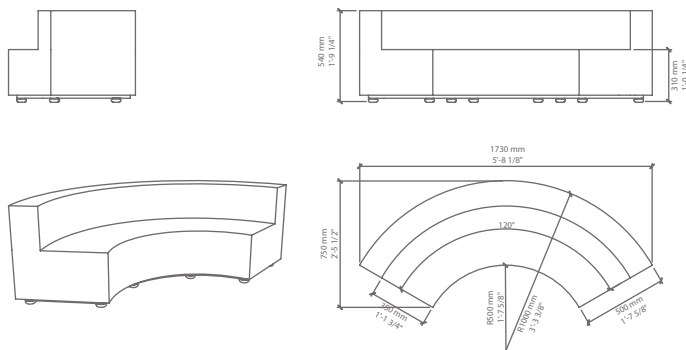

- ..... Little Miss O small - bench with backrest QM Foam skin
- ..... Little Miss O small - bench with backrest QM Plus foamskin double
- ..... Little Miss O small - bench with backrest QM Tex foamskin Tex
- ..... Little Miss O small - bench with backrest QM CAT 1
- ..... Little Miss O small - bench with backrest QM CAT 2
- ..... Little Miss O small - bench with backrest QM CAT 0/COM

#### LITTLE MISS O SMALL - bench without backrest

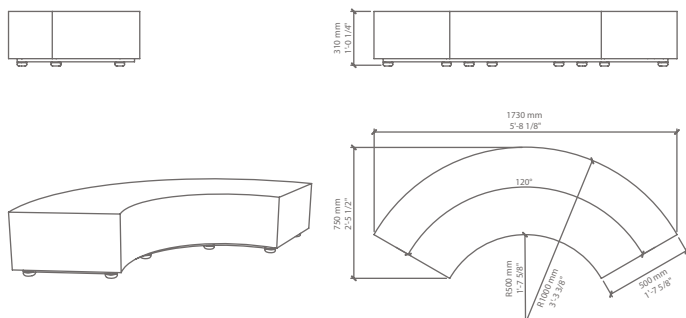

- ..... Little Miss O small - bench QM Foam skin
- ..... Little Miss O small - bench QM Plus foamskin double
- ..... Little Miss O small - bench QM Tex foamskin Tex
- ..... Little Miss O small - bench QM CAT 1
- ..... Little Miss O small - bench QM CAT 2
- ..... Little Miss O small - bench QM CAT 0/COM

0 = product price in calculation - contact our office for pricing

# LITTLE MISS O

## DESIGN CONCRETE AMSTERDAM



**Quinze & milan**



When UN Studio asked them to design certain areas for their major project, the Mercedes Benz Museum in Stuttgart, Germany, CONCRETE AMSTERDAM based all its designwork, down to the very detail on the specific identity of the owner. Their aim was to create identity within a total space experience: create individual worlds where a single visitor identifies with and which invites him to stay. The dishes, table linen and silverware in the restaurant as well as the division of the spaces are all in a way renditions of the three-pointed Mercedes Benz logo. LITTLE MISS O, which is placed in the children island, is a result from that research and provides an ideal playground where to nurse children and play with them.

Custom color or sizes are available upon request.

### LITTLE MISS O LARGE

\*DELIVERY KNOCK DOWN IN FOUR PIECES

#### LITTLE MISS O LARGE COMPLETE

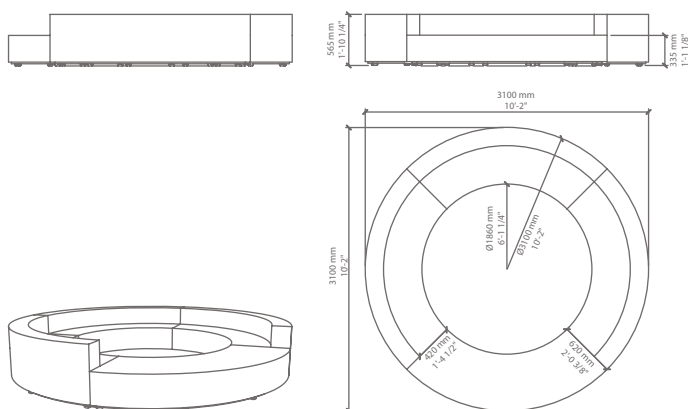

- Little Miss O large complete (no floor) QM Foam skin
- Little Miss O large complete (no floor) QM Plus foamskin double
- Little Miss O large complete (no floor) QM Tex foamskin Tex
- Little Miss O large complete (no floor) QM CAT 1
- Little Miss O large complete (no floor) QM CAT 2
- Little Miss O large complete (no floor) QM CAT 0/COM

#### LITTLE MISS O LARGE - bench with backrest

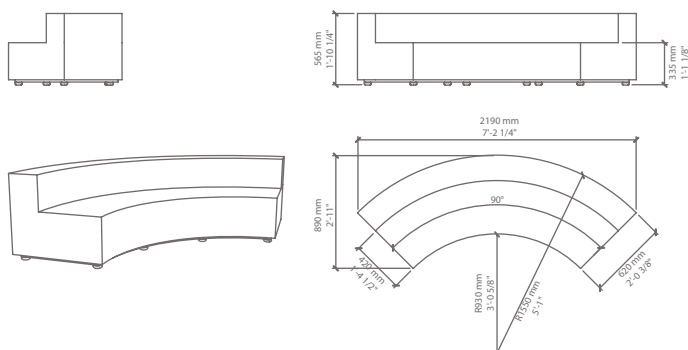

- Little Miss O large - bench with backrest QM Foam skin
- Little Miss O large - bench with backrest QM Plus foamskin double
- Little Miss O large - bench with backrest QM Tex foamskin Tex
- Little Miss O large - bench with backrest QM CAT 1
- Little Miss O large - bench with backrest QM CAT 2
- Little Miss O large - bench with backrest QM CAT 0/COM

#### LITTLE MISS O LARGE - bench without backrest

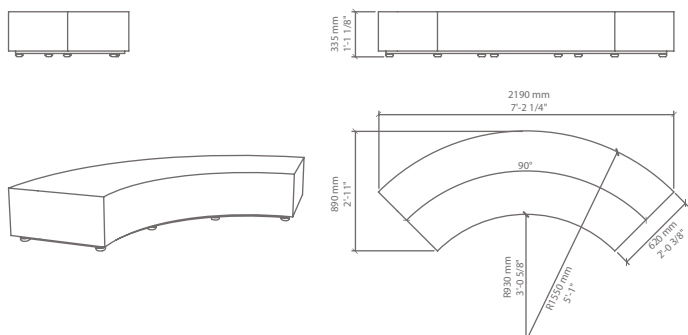

- Little Miss O large - bench QM Foam skin
- Little Miss O large - bench QM Plus foamskin double
- Little Miss O large - bench QM Tex foamskin Tex
- Little Miss O large - bench QM CAT 1
- Little Miss O large - bench QM CAT 2
- Little Miss O large - bench QM CAT 0/COM

0 = product price in calculation - contact our office for pricing

Little Miss O large - bench with backrest	QM FOAM	QF.LMO.LBB	€ 4.227	31.706
Little Miss O large - bench with backrest	QM PLUS	QP.LMO.LBB	€ 4.504	33.777
Little Miss O large - bench with backrest	QM TEX	QT.LMO.LBB	€ 5.792	43.437
Little Miss O large - bench with backrest	QM CAT 1	QU1.LMO.LBB	€ 4.758	35.683
Little Miss O large - bench with backrest	QM CAT 2	QU2.LMO.LBB	€ 5.289	39.665
Little Miss O large - bench with backrest	QM CAT 0/COM	QU0.LMO.LBB	€ 4.527	33.951
Little Miss O large - bench	QM FOAM	QF.LMO.LB	€ 2.794	20.956
Little Miss O large - bench	QM PLUS	QP.LMO.LB	€ 3.008	22.560
Little Miss O large - bench	QM TEX	QT.LMO.LB	€ 4.715	35.365
Little Miss O large - bench	QM CAT 1	QU1.LMO.LB	€ 3.929	29.470
Little Miss O large - bench	QM CAT 2	QU2.LMO.LB	€ 4.421	33.156
Little Miss O large - bench	QM CAT 0/COM	QU0.LMO.LB	€ 3.715	27.866
Little Miss O large complete (no floor)	QM FOAM	QF.LMO.COM	€ 15.477	116.077
Little Miss O large complete (no floor)	QM PLUS	QP.LMO.COM	€ 16.519	123.896
Little Miss O large complete (no floor)	QM TEX	QT.LMO.COM	€ 22.090	165.677
Little Miss O large complete (no floor)	QM CAT 1	QU1.LMO.COM	€ 18.202	136.515
Little Miss O large complete (no floor)	QM CAT 2	QU2.LMO.COM	€ 20.287	152.150
Little Miss O large complete (no floor)	QM CAT 0/COM	QU0.LMO.COM	€ 17.296	129.718
Little Miss O large floor	QM FOAM	QF.LMO.LFL	€ 2.490	18.678
Little Miss O large floor	QM PLUS	QP.LMO.LFL	€ 2.797	20.974
Little Miss O large floor	QM TEX	QT.LMO.LFL	€ 3.031	22.729
Little Miss O large floor	QM CAT 1	QU1.LMO.LFL	€ 1.819	13.643
Little Miss O large floor	QM CAT 2	QU2.LMO.LFL	€ 2.114	15.856
Little Miss O large floor	QM CAT 0/COM	QU0.LMO.LFL	€ 1.691	12.681
Little Miss O small - bench with backrest	QM FOAM	QF.LMO.SBB	€ 3.407	25.553
Little Miss O small - bench with backrest	QM PLUS	QP.LMO.SBB	€ 3.606	27.047
Little Miss O small - bench with backrest	QM TEX	QT.LMO.SBB	€ 4.810	36.071
Little Miss O small - bench with backrest	QM CAT 1	QU1.LMO.SBB	€ 3.370	25.278
Little Miss O small - bench with backrest	QM CAT 2	QU2.LMO.SBB	€ 3.734	28.005
Little Miss O small - bench with backrest	QM CAT 0/COM	QU0.LMO.SBB	€ 3.212	24.090
Little Miss O small - bench	QM FOAM	QF.LMO.SB	€ 2.203	16.526
Little Miss O small - bench	QM PLUS	QP.LMO.SB	€ 2.350	17.627
Little Miss O small - bench	QM TEX	QT.LMO.SB	€ 3.410	25.575
Little Miss O small - bench	QM CAT 1	QU1.LMO.SB	€ 2.862	21.468
Little Miss O small - bench	QM CAT 2	QU2.LMO.SB	€ 3.226	24.196
Little Miss O small - bench	QM CAT 0/COM	QU0.LMO.SB	€ 2.704	20.281
Little Miss O small complete (no floor)	QM FOAM	QF.LMO.SCOM	€ 9.018	67.632
Little Miss O small complete (no floor)	QM PLUS	QP.LMO.SCOM	€ 9.563	71.722
Little Miss O small complete (no floor)	QM TEX	QT.LMO.SCOM	€ 13.029	97.718
Little Miss O small complete (no floor)	QM CAT 1	QU1.LMO.SCOM	€ 9.603	72.021

Little Miss O small complete (no floor) QM CAT 2	QU2.LMO.SCOM	€ 10.694	80.207
Little Miss O small complete (no floor) QM CAT 0/COM	QU0.LMO.SCOM	€ 9.128	68.462
Little Miss O small floor QM FOAM	QF.LMO.SFL	€ 1.382	10.364
Little Miss O small floor QM PLUS	QP.LMO.SFL	€ 1.486	11.142
Little Miss O small floor QM TEX	QT.LMO.SFL	€ 1.927	14.453
Little Miss O small floor QM CAT 1	QU1.LMO.SFL	€ 1.513	11.351
Little Miss O small floor QM CAT 2	QU2.LMO.SFL	€ 1.710	12.827
Little Miss O small floor QM CAT 0/COM	QU0.LMO.SFL	€ 1.428	10.710
Little Miss O connector QM	QW.LMO.CON	€ 174	1.309



M2

DESIGN SCOTT WILSON

2003



*Quinze & milan*



0 = product price in calculation - contact our office for pricing



# M2

DESIGN SCOTT WILSON

2003



**Quinze & milan**

Flexible by nature and ideal for large public spaces, the M2 is a modular seating system designed by Scott Wilson for Quinze & Milan. Three basic units (corner, linear and level units), each 1m2, supported by powder-coated steel frames fit together to form the desired configuration. Components can be interconnected or can stand alone. Light fittings can be integrated into the seating elements. M2 has received enthusiastic reviews, as well as honourable mentions at the ISDA Awards and the prestigious ID Design Awards.

Steel elements are powder-coated in standard grey (RAL 9007) and black (RAL 9005). Sidetable standard grey or black.

## M2 FLAT

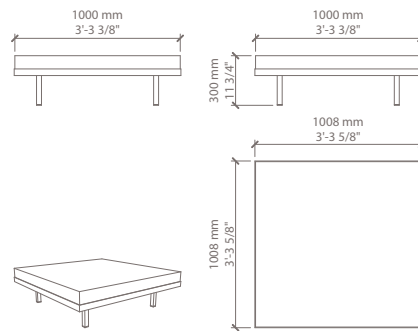

- ..... M2 incl. Base flat QM Foam skin
- ..... M2 incl. Base flat QM Plus foamskin double
- ..... M2 incl. base flat QM Tex foamskin Tex
- ..... M2 incl. Base flat QM CAT 1
- ..... M2 incl. Base flat CAT 2
- ..... M2 incl. Base flat QM CAT 0/COM

## M2 CORNER

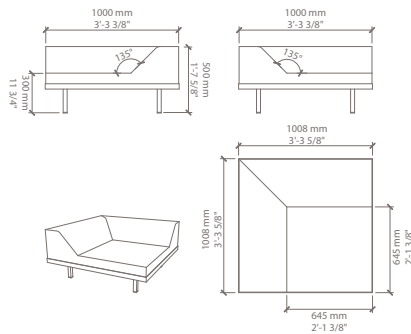

- ..... M2 incl. Base corner QM Foam skin
- ..... M2 incl. Base corner QM Plus foamskin double
- ..... M2 incl. Base corner QM Tex foamskin Tex
- ..... M2 incl. Base corner QM CAT 1
- ..... M2 incl. Base corner CAT 2
- ..... M2 incl. Base corner QM CAT 0/COM

## M2 STRAIGHT

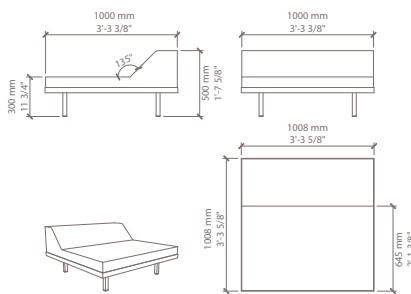

- ..... M2 incl. Base straight QM Foam skin
- ..... M2 incl. Base straight QM Plus foamskin double
- ..... M2 incl. Base straight QM Tex foamskin Tex
- ..... M2 incl. Base straight QM CAT 1
- ..... M2 incl. Base straight CAT 2
- ..... M2 incl. Base straight QM CAT 0/COM

## M2 SIDE TABLE

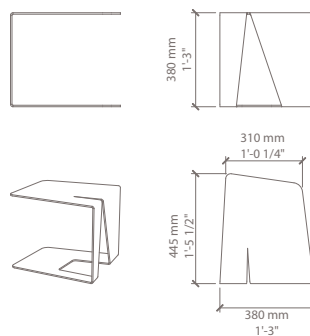

M2 side table Metal powdercoated

0 = product price in calculation - contact our office for pricing

M2 incl. Base flat QM FOAM	QF.M2.FLA	€ 1.739	13.039
M2 incl. Base flat QM PLUS	QP.M2.FLA	€ 1.883	14.126
M2 incl. base flat QM TEX	QT.M2.FLA	€ 2.355	17.665
M2 incl. Base flat QM CAT 1	QU1.M2.FLA	€ 1.686	12.643
M2 incl. Base flat CAT 2	QU2.M2.FLA	€ 1.823	13.676
M2 incl. Base flat QM CAT 0/COM	QU0.M2.FLA	€ 1.786	13.397
M2 incl. Base straight QM FOAM	QF.M2.STR	€ 2.087	15.653
M2 incl. Base straight QM PLUS	QP.M2.STR	€ 2.262	16.968
M2 incl. Base straight QM TEX	QT.M2.STR	€ 3.453	25.896
M2 incl. Base straight QM CAT 1	QU1.M2.STR	€ 2.692	20.192
M2 incl. Base straight CAT 2	QU2.M2.STR	€ 2.899	21.740
M2 incl. Base straight QM CAT 0/COM	QU0.M2.STR	€ 2.763	20.720
M2 incl. Base corner QM FOAM	QF.M2.COR	€ 2.461	18.459
M2 incl. Base corner QM PLUS	QP.M2.COR	€ 2.648	19.862
M2 incl. Base corner QM TEX	QT.M2.COR	€ 3.819	28.643
M2 incl. Base corner QM CAT 1	QU1.M2.COR	€ 3.040	22.802
M2 incl. Base corner CAT 2	QU2.M2.COR	€ 3.315	24.866
M2 incl. Base corner QM CAT 0/COM	QU0.M2.COR	€ 3.081	23.107
M2 incl. Base flat table coated	M2.FLA.TAB	€ 1.469	11.017
M2 side table Metal powdercoated	M2.SID.TAB	€ 658	4.937
M2 base base Metal powdercoated	M2.BASE	€ 900	6.746

MATRASS  
DESIGN SAQ  
2000



*Quinze & milan*



0 = product price in calculation - contact our office for pricing

# MATRASS

## DESIGN SAQ

### 2000



**Quinze & milan**



MATRASS, an offspring of PRIMARY that was purpose-designed for lounge settings, is available in four sizes, with or without backrests. All pieces can be mixed and matched to create unique arrangements. MATRASS fits right into any number of environments. Tuck it into a corner of the loft or living room. Use it in the children's room. Park it next to the swimming pool, or add an extra level of comfort to the wellness space.

MATRASS is also available upholstered in leather and fabric.  
Custom color or sizes are available upon request.

MATRASS SEAT 75

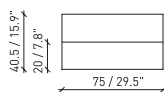
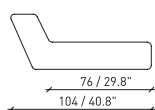

Matrass SEAT 75 QM Foam skin

Matrass SEAT 75 QM Plus foamskin double

MATRASS SEAT 150

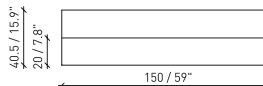
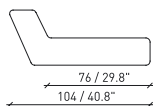

Matrass SEAT 150 QM Foam skin

Matrass SEAT 150 QM Plus foamskin double

MATRASS MAT 75

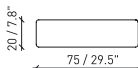
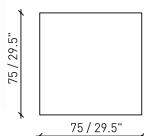

Matrass MAT 75 QM Foam skin

Matrass MAT 75 QM Plus foamskin double

MATRASS MAT 150

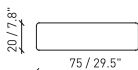
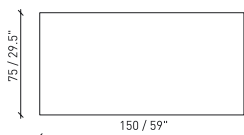

Matrass MAT 150 QM Foam skin

Matrass MAT 150 QM Plus foamskin double

0 = product price in calculation - contact our office for pricing

Matrass MAT 75 QM FOAM	QF.MAT.MAT75	€ 612	4.588
Matrass MAT 75 QM PLUS	QP.MAT.MAT75	€ 695	5.211
Matrass MAT 150 QM FOAM	QF.MAT.MAT150	€ 1.069	8.019
Matrass MAT 150 QM PLUS	QP.MAT.MAT150	€ 1.230	9.224
Matrass SEAT 75 QM FOAM	QF.MAT.SEAT75	€ 919	6.895
Matrass SEAT 75 QM PLUS	QP.MAT.SEAT75	€ 1.039	7.792
Matrass SEAT 150 QM FOAM	QF.MAT.SEAT150	€ 1.461	10.959
Matrass SEAT 150 QM PLUS	QP.MAT.SEAT150	€ 1.676	12.567

NORA

DESIGN Lionel DOYEN

2017



ALSO  
AVAILABLE IN  
OUTDOOR  
VERSION



0 = product price in calculation - contact our office for pricing

# NORA

DESIGN Lionel DOYEN

2017



NORA allows you to play with seats, backrests and armrests.

Each sofa is modular and is built up based on 4 standard frames.

All elements are fixed to a base plate, but can easily be re-arranged. All cushions can be upholstered with different fabrics of your choice.

The baseframe is aluminum with a powdercoating and the feet are wooden legs in oak natural. The complete sofa can be adapted to outdoor use, by changing the wooden feet to acacia, cushions and fabrics in outdoor suitable materials.

Contact our sales office for more pricing options.

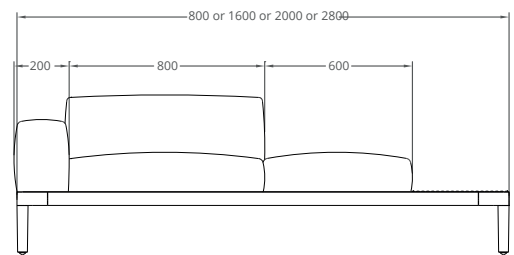
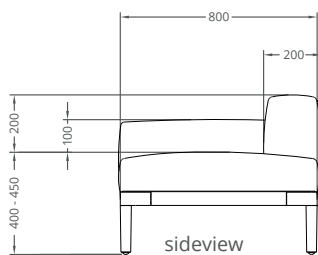

Frontview

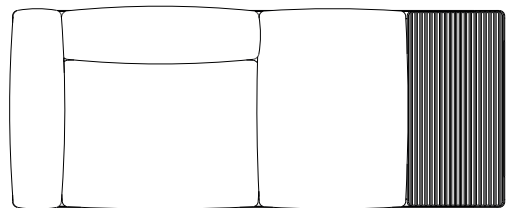
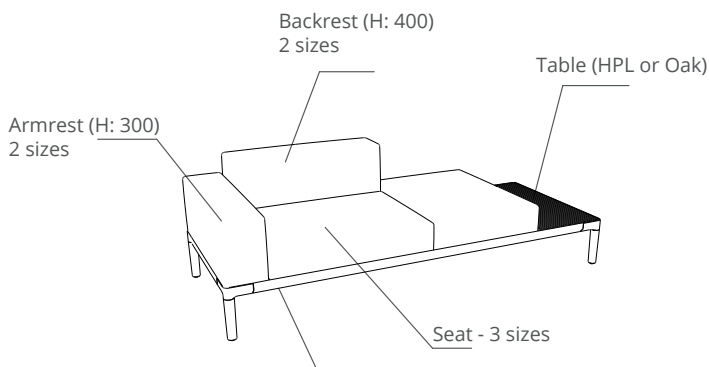

Topview

0 = product price in calculation - contact our office for pricing

NORA

NORA allows you to play with seats, backrests and armrests.

Each sofa is modular and is built up based on 4 standard frames.

Contact our sales office for more pricing options.



### Frames

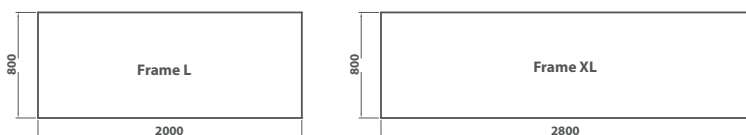
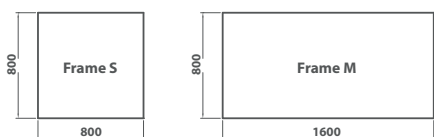

- Nora - frame s 80 - Metal powdercoated/oak legs
- Nora - frame M 160 - Metal powdercoated/oak legs
- Nora - frame L 200 - Metal powdercoated/oak legs
- Nora - frame XL 280 - Metal powdercoated/oak legs

### Seats

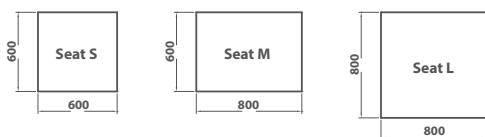

- Nora - Seat S 60x60 - fabric CAT 0/COM
- Nora - Seat S 60x60 - fabric CAT 1
- Nora - Seat S 60x60 - fabric CAT 2
- Nora - Seat M 80x60 - fabric CAT 0/COM
- Nora - Seat M 80x60 - fabric CAT 1
- Nora - Seat M 80x60 - fabric CAT 2
- Nora - Seat L 80x80 - fabric CAT 0/COM
- Nora - Seat L 80x80 - fabric CAT 1

### Armrests

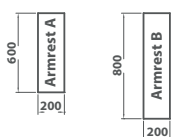

- Nora - Seat L 80x80 - fabric CAT 2
- Nora - Seat L 80x80 - fabric CAT 1
- Nora - Armrest A - fabric CAT 0/COM
- Nora - Armrest A - fabric CAT 1
- Nora - Armrest A - fabric CAT 2
- Nora - Armrest B - fabric CAT 0/COM
- Nora - Armrest B - fabric CAT 1
- Nora - Armrest B - fabric CAT 2

### Backrests



- Nora - Backrest A - fabric CAT 0/COM
- Nora - Backrest A - fabric CAT 1
- Nora - Backrest A - fabric CAT 2
- Nora - Backrest B - fabric CAT 0/COM
- Nora - Backrest B - fabric CAT 1
- Nora - Backrest B - fabric CAT 2

### Tables

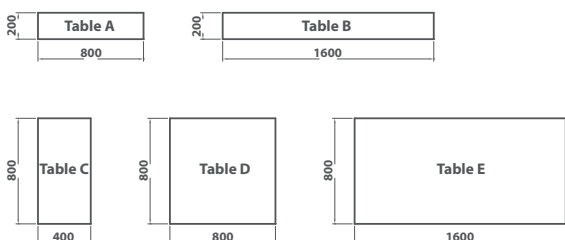

- Nora - table A - HPL 20\*80cm
- Nora - table B - HPL 160\*20cm
- Nora - table C - HPL 80\*40cm
- Nora - table D - HPL 80\*80cm
- Nora - table A - wood 20\*80cm - oak pattern
- Nora - table B - wood 20\*160cm - oak pattern
- Nora - table C - wood 80\*40cm - oak pattern
- Nora - table D - wood 80\*80cm - oak pattern

0 = product price in calculation - contact our office for pricing



some proposals based on **frame S**

MODEL S\_01

Nora - Model S01 - CAT 0/COM

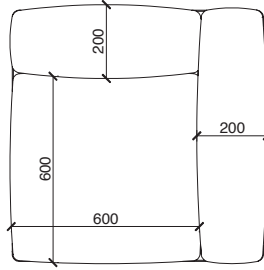

parts list:  
Frame S  
Seat S  
Armrest B  
Backrest A

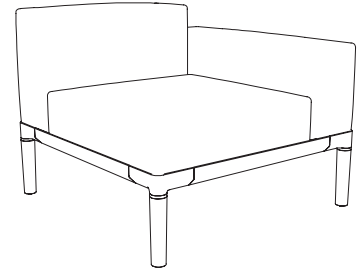

MODEL S\_02

Nora - Model S02 - CAT 0/COM

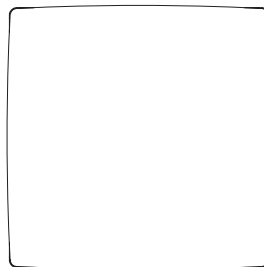

parts list:  
Frame S  
Seat L

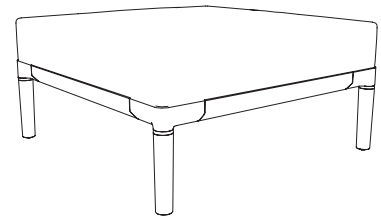

MODEL S\_03

Nora - Model S03 - CAT 0/COM

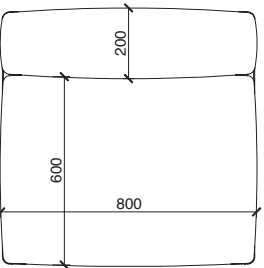

parts list:  
Frame S  
Seat M  
Armrest B

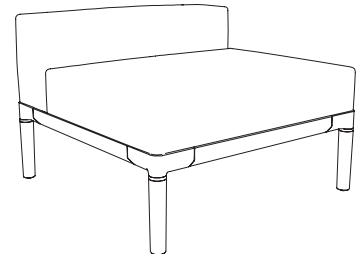

MODEL S\_04

Nora - Model S04 - CAT 0/COM

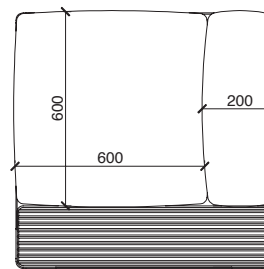

parts list:  
Frame S  
Seat S  
backrest A  
Table HPL or Oak

pricing for version with HPL table  
not like on the image (oak table, price on request)

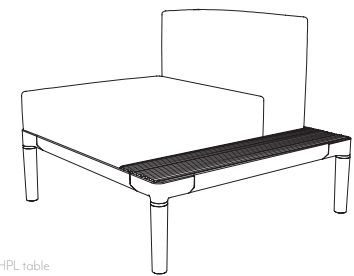

MODEL S\_05

Nora - Model S05 - CAT 0/COM

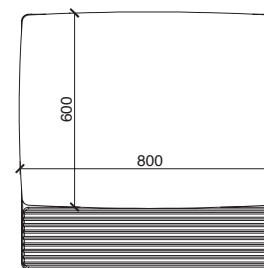
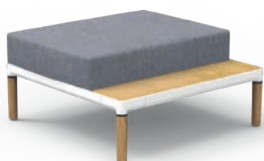

parts list:  
Frame S  
Seat M  
Table HPL or Oak

pricing for version with HPL table  
not like on the image (oak table, price on request)



0 = product price in calculation - contact our office for pricing

# NORA

DESIGN Lionel DOYEN

2017



## MODEL S\_06

Nora - Model S06 - table oak pattern

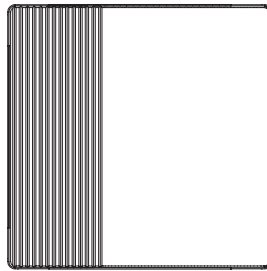

parts list:  
Frame S  
Table HPL or Oak

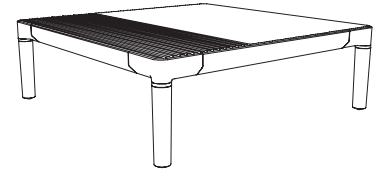

some proposals based on [frame M](#)

## MODEL M\_01

Nora - Model M01 - CAT 0/COM



parts list:  
Frame M  
2 x Seat S  
2 x Armrest B  
2 x Backrest A

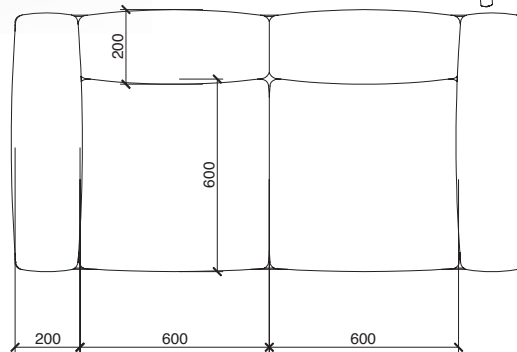
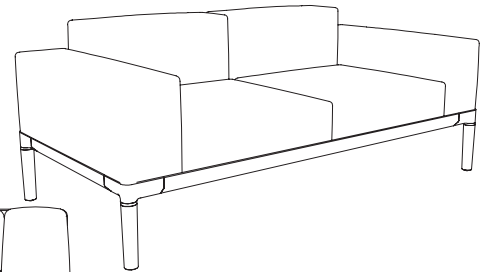

## MODEL M\_02

Nora - Model M02 - CAT 0/COM



parts list:  
Frame M  
2 x Seat L

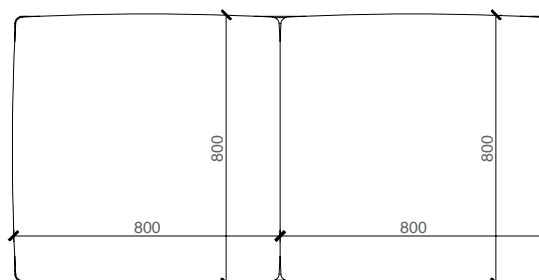
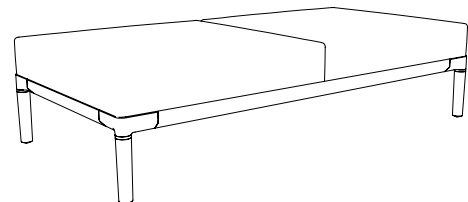

0 = product price in calculation - contact our office for pricing

# NORA

DESIGN Lionel DOYEN

2017



## MODEL M\_03

- parts list:  
Frame M  
2 x Seat M  
Wooden table HPL or Oak

Nora - Model M03 - CAT 0/COM

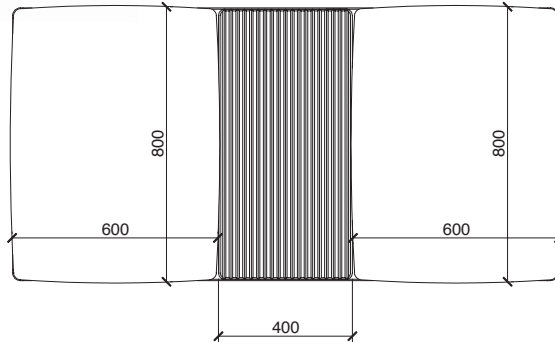
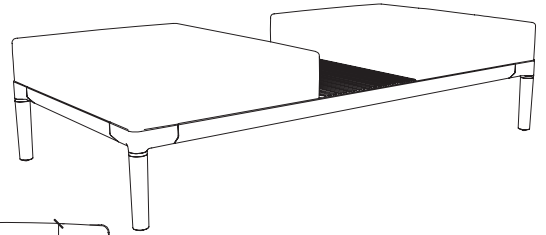

## MODEL M\_04

- parts list:  
Frame M  
2 x Seat M  
2 x Armrest B

Nora - Model M04 - CAT 0/COM

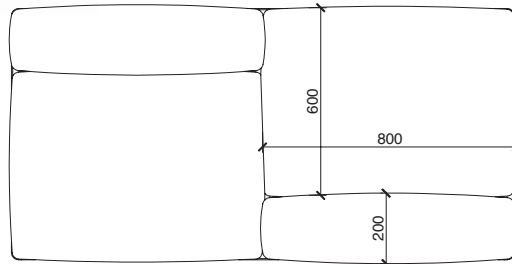
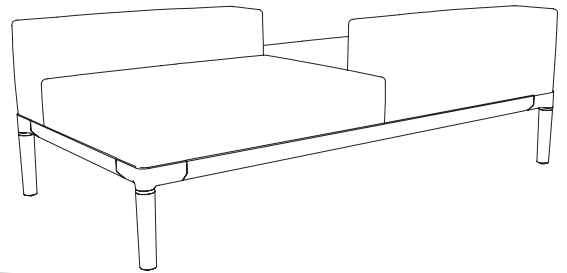

## MODEL M\_05

- parts list:  
Frame M  
Seat S  
Seat M  
2 x Armrest B

Nora - Model M05 - CAT 0/COM

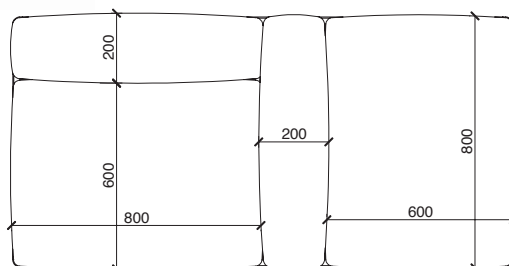
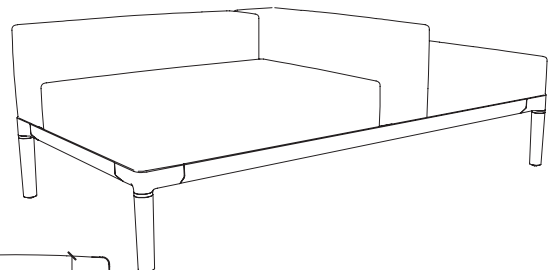

0 = product price in calculation - contact our office for pricing

## MODEL M\_06

- parts list:  
 Frame M  
 Seat M  
 Seat S  
 Backrest A

Nora - Model M06 - CAT 0/COM

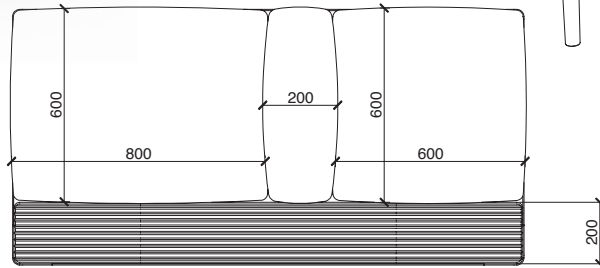
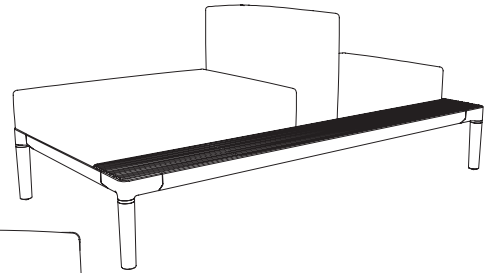

## MODEL M\_07

- parts list:  
 Frame M  
 2 x Seat S  
 2 x Backrest A  
 Wooden table HPL or Oak

Nora - Model M07 - CAT 0/COM

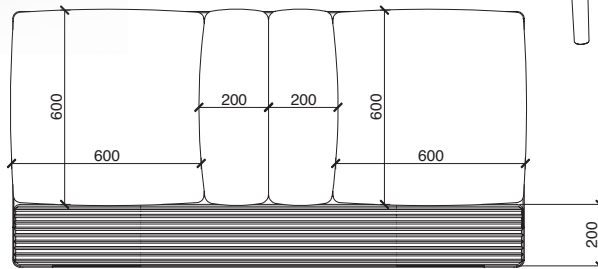
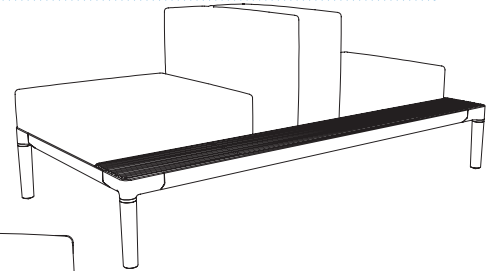

## MODEL M\_08

- parts list:  
 Frame M  
 2 x Seat S  
 2 x Backrest A  
 Wooden table HPL or Oak

Nora - Model M08 - CAT 0/COM

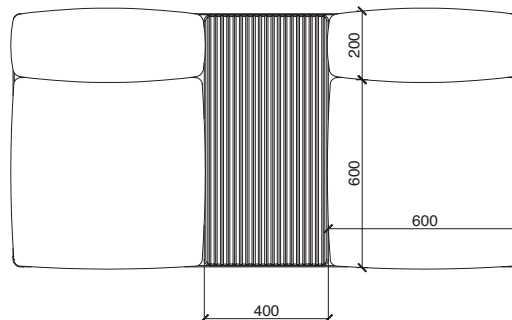
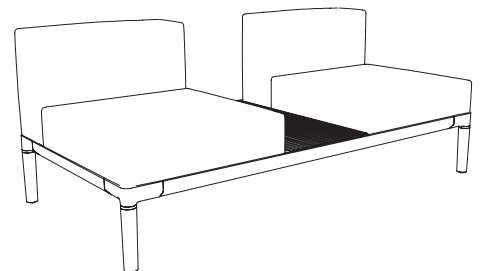

0 = product price in calculation - contact our office for pricing

## MODEL L\_01

Nora - Model L01 - CAT 0/COM

- parts list:  
 Frame L  
 2 x Seat L  
 2 x Armrest B  
 2 x Backrest B

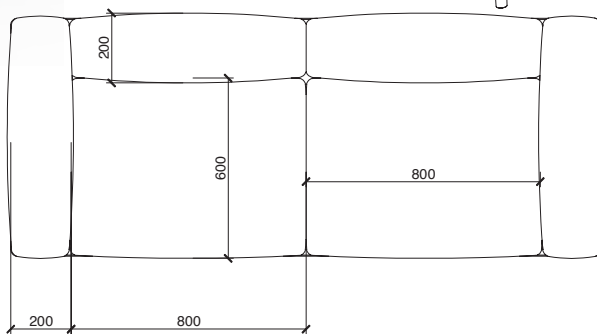
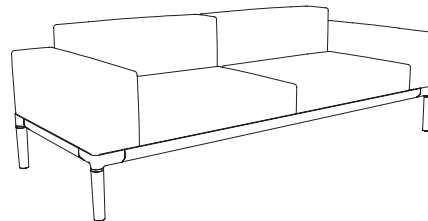

## MODEL L\_02

Nora - Model L02 - CAT 0/COM

- parts list:  
 Frame L  
 2 x Seat S  
 2 x Backrest A  
 2 x Armrest B

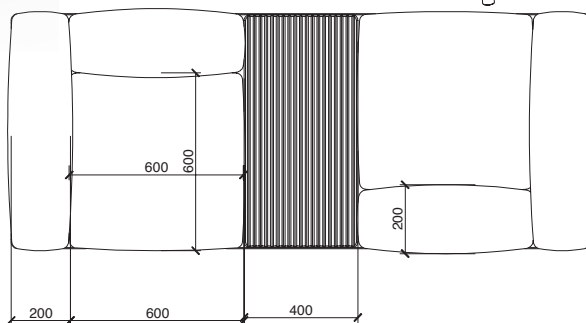
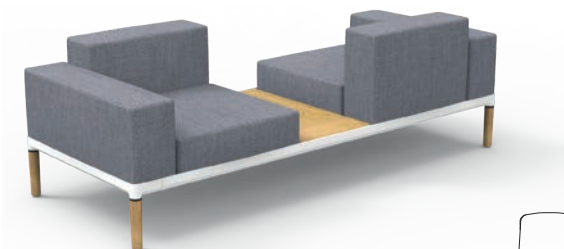
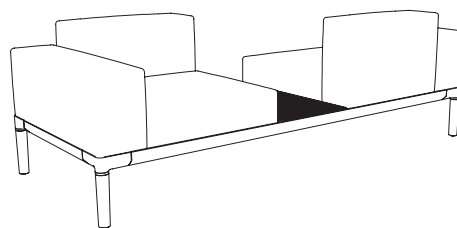

## MODEL L\_03

Nora - Model L03 - CAT 0/COM

- parts list:  
 Frame L  
 3 x Seat S  
 3 x Backrest A  
 Armrest B

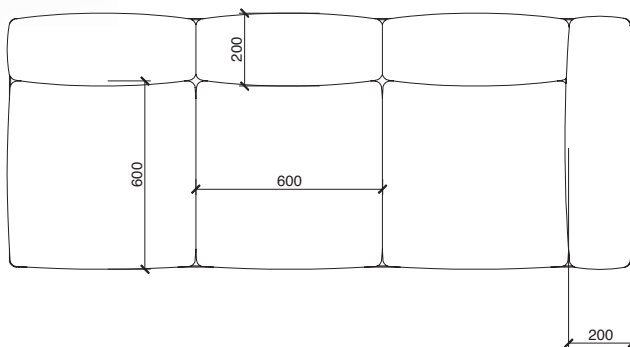
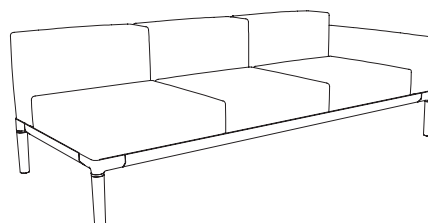

0 = product price in calculation - contact our office for pricing

# NORA

DESIGN Lionel DOYEN

2017



## MODEL L\_04

Nora - Model L04 - CAT 0/COM

- parts list:  
Frame L  
3 x Seat S  
3 x Backrest A  
armrest B

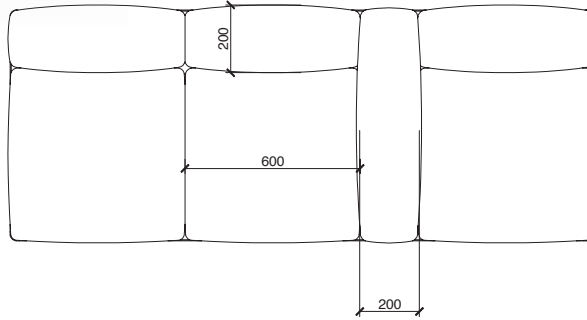
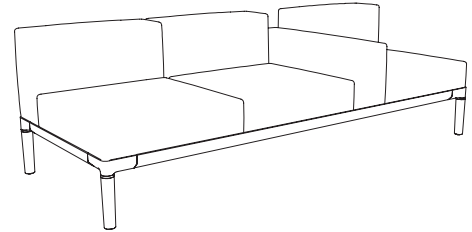

## MODEL L\_05

Nora - Model L05 - CAT 0/COM

- parts list:  
Frame L  
2 x Seat L  
4 x armrest B

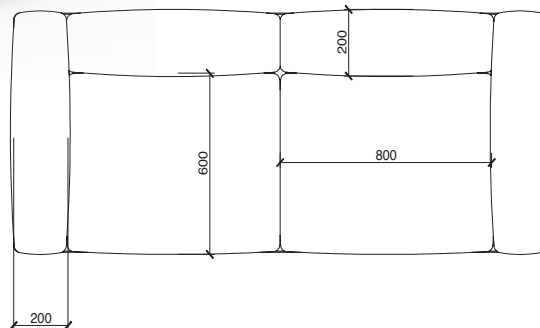
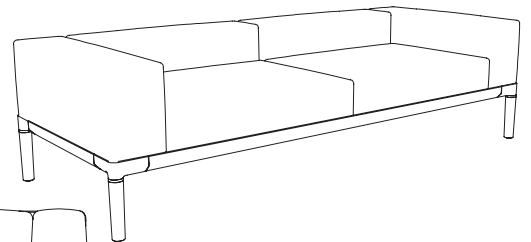

## MODEL L\_06

Nora - Model L06 - CAT 0/COM

- parts list:  
Frame L  
2 X Seat M  
2 x armrest A  
table C

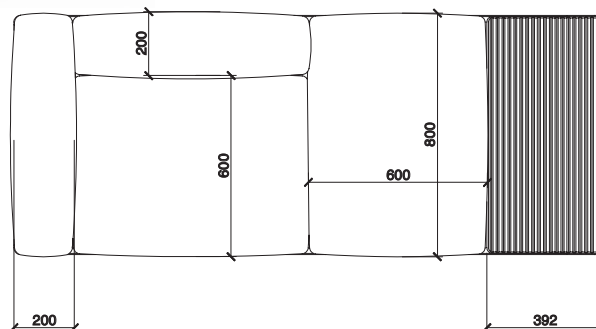
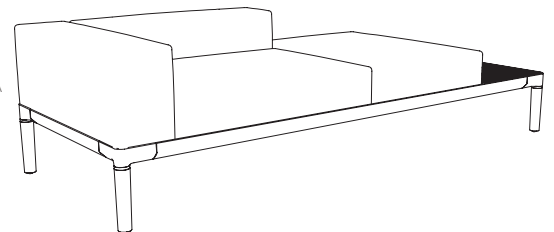

0 = product price in calculation - contact our office for pricing

# NORA

DESIGN Lionel DOYEN

2017



MODEL XL\_01

parts list:  
Frame XL  
3 x Seat S  
3 x Backrest A  
2 x armrest B

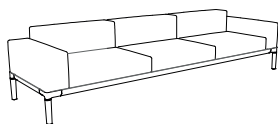
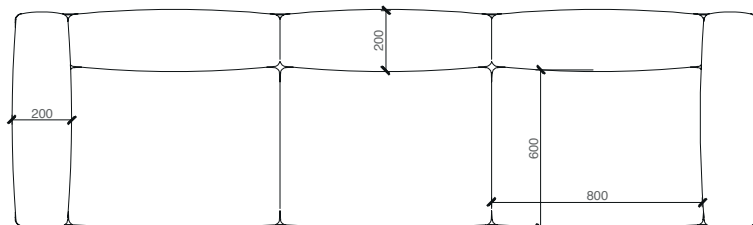
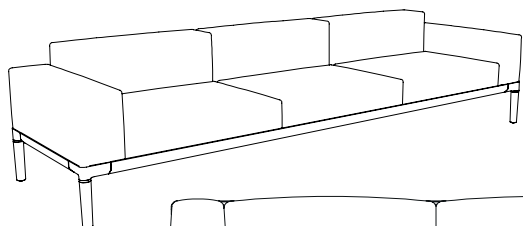

Nora XL 01

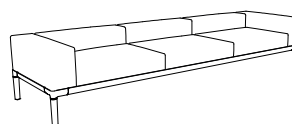

Nora XL 02

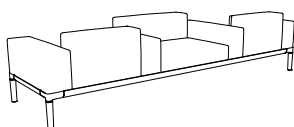

Nora XL 03

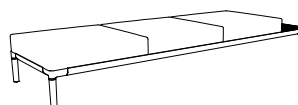

Nora XL 04

0 = product price in calculation - contact our office for pricing

Nora - frame s 80 - Metal powdercoated/oak legs	NOR.FRA.S80	€ 1.303	9.776
Nora - frame M 160 - Metal powdercoated/oak legs	NOR.FRA.M160	€ 1.950	14.623
Nora - frame L 200 - Metal powdercoated/oak legs	NOR.FRA.L200	€ 2.067	15.504
Nora - frame XL 280 - Metal powdercoated/oak legs	NOR.FRA.XL280	€ 2.951	22.136
Nora - Seat S 60x60 - fabric CAT 0/COM	QU0.NOR.S60/60	€ 325	2.438
Nora - Seat S 60x60 - fabric CAT 1	QU1.NOR.S60/60	€ 447	3.354
Nora - Seat S 60x60 - fabric CAT 2	QU2.NOR.S60/60	€ 575	4.312
Nora - Seat M 80x60 - fabric CAT 0/COM	QU0.NOR.S80/60	€ 325	2.438
Nora - Seat M 80x60 - fabric CAT 1	QU1.NOR.S60/80	€ 476	3.566
Nora - Seat M 80x60 - fabric CAT 2	QU2.NOR.S60/80	€ 633	4.746
nora - Seat L 80x80 - fabric CAT 0/COM	QU0.NOR.S80/80	€ 325	2.438
Nora - Seat L 80x80 - fabric CAT 1	QU1.NOR.S80/80	€ 476	3.566
Nora - Seat L 80x80 - fabric CAT 2	QU2.NOR.S80/80	€ 633	4.746
Nora - Armrest low/ Backrest high 60 - fabric CAT 0	QU0.NOR.60	€ 376	2.822
Nora - Armrest low/ Backrest high 60 - fabric CAT 1	QU1.NOR.60	€ 499	3.739
Nora - Armrest low/ Backrest high 60 - fabric CAT 2	QU2.NOR.60	€ 626	4.697
Nora - Armrest B - fabric CAT 0/COM	QU0.ARM.B80	€ 402	3.015
Nora - Armrest B - fabric CAT 1	QU1.ARM.B80	€ 581	4.354
Nora - Armrest B - fabric CAT 2	QU2.ARM.B80	€ 767	5.755
Nora - Armrest low/ Backrest high 80 - fabric CAT 0	QU0.NOR.80	€ 393	2.949
Nora - Armrest low/ Backrest high 80 - fabric CAT 1	QU1.NOR.80	€ 532	3.989
Nora - Armrest low/ Backrest 80 - fabric CAT 2	QU2.NOR.80	€ 650	4.873
Nora - table A - HPL 20*80cm	QW.NOR.THA 20*80	€ 318	2.385
Nora - table B - HPL 160*20cm	QW.NOR.THB20*160	€ 575	4.309
Nora - table C - HPL 80*40cm	QW.NOR.THC 80*40	€ 318	2.385
Nora - table D - HPL 80*80cm	QW.NOR.THD 80*80	€ 472	3.539
Nora - table A - wood 20*80cm - oak pattern	QW.NOR.TOA20*80	€ 631	4.734
Nora - table B - wood 20*160cm - oak pattern	QW.NOR.TOB 20*160	€ 675	5.066
Nora - table C - wood 80*40cm- oak pattern	QW.NOR.TOC80*40	€ 811	6.080
Nora - table D - wood 80*80cm - oak pattern	QW.NOR.TOD80*80	€ 1.298	9.736
Nora - L 02 - 2seat 2arm 2back table	QU1.NOR.L02	€ 4.256	31.922
Nora - L 03 - 3seat 1arm 4back	QU1.NOR.L03	€ 4.624	34.679
Nora - L 04 - 3seat 1arm 3back	QU1.NOR.L04	€ 4.624	34.679
Nora - L 05 - 2seat 4arm	QU1.NOR.L05	€ 4.325	32.436
Nora - L 06 - 2seat 2arm table	QU1.NOR.L06	€ 3.788	28.407
Nora - M 02 - 2seat	QU1.NOR.MOD02	€ 2.600	19.497
Nora - M 03 - 2seat table	QU1.NOR.M03	€ 2.917	21.874
Nora - M 04 - 2seat 2back	QU1.NOR.M04	€ 3.403	25.526
Nora - M 05 - 2seat 2arm	QU1.NOR.M05	€ 3.403	25.526
Nora - M 06 - 2seat 1back table	QU1.NOR.M06	€ 3.174	23.806



Nora - M 07 - 2seat 2back table	QU1.NOR.M07	€ 3.961	29.706
Nora - M 08 - 2seat 2back table	QU1.NOR.M08	€ 3.780	28.347
Nora - S 02 - seat	QU1.NOR.S02	€ 1.628	12.213
Nora - S 01 - seat arm back	QU1.NOR.S01	€ 2.424	18.177
Nora - S 03 - seat back/arm	QU1.NOR.S03	€ 2.458	18.431
Nora - S 04 - seat back table	QU1.NOR.S04	€ 2.415	18.114
Nora - S 05 - seat table	QU1.NOR.S05	€ 2.022	15.163
Nora - S 06 - table	QU1.NOR.S06	€ 2.599	19.489
Nora - XL 01 - 3seat 5arm/back	QU1.NOR.XL01	€ 7.281	54.604



0 = product price in calculation - contact our office for pricing



0 = product price in calculation - contact our office for pricing

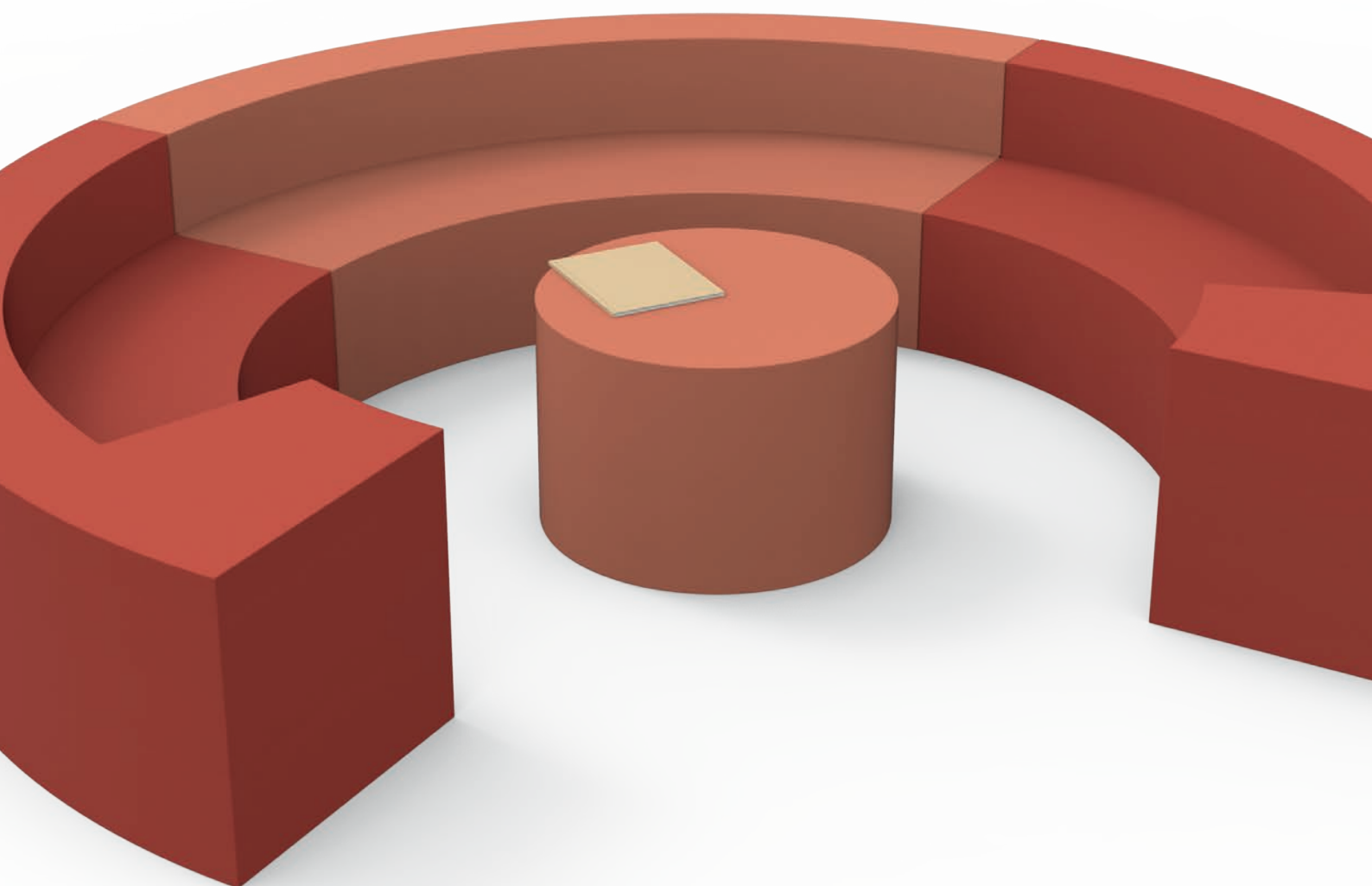

0 = product price in calculation - contact our office for pricing



OSAKA is the new circular bench system. Gathering around a curved bench increases interaction and social communication.

This system is built up out of 4 standard modules: a curved bench without backrest, a curved bench with backrest, a curved bench with backrest and armrest (left or right) and a circular bench with extra seating at the outside.

Custom color or sizes are available upon request.

#### OSAKA BENCH WITH BACKREST & ARMREST (LEFT OR RIGHT)

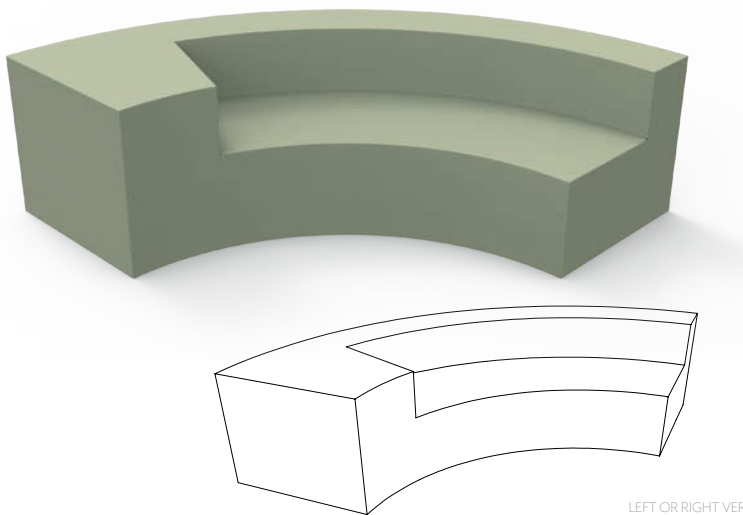

LEFT OR RIGHT VERSION

- Osaka - Bench WITH backrest & armrest - QM Foam skin
- Osaka - Bench WITH backrest & armrest - QM Plus foamskin double
- Osaka - Bench WITH backrest & armrest - QM Tex foamskin Tex
- Osaka - Bench WITH backrest & armrest - fabric CAT 0/COM
- Osaka - Bench WITH backrest & armrest - fabric CAT 1
- Osaka - Bench WITH backrest & armrest - fabric CAT 2

#### OSAKA BENCH WITH BACKREST AND MIRRORED SEAT

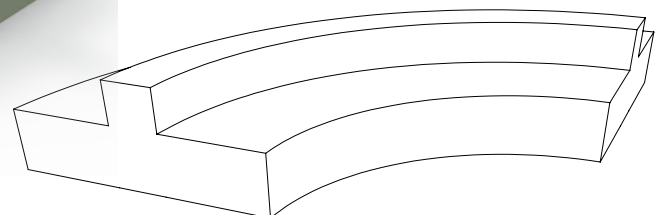
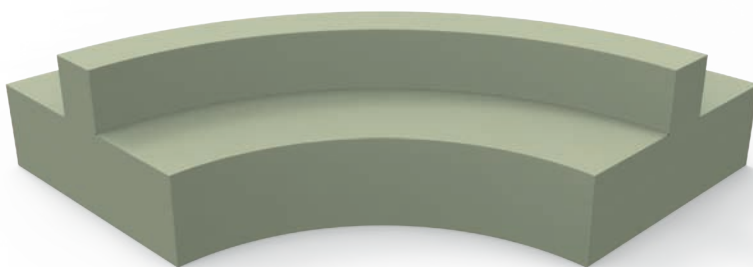

- Osaka - Bench mirror WITH backrest - QM Foam skin
- Osaka - Bench mirror WITH backrest - QM Plus foamskin double
- Osaka - Bench mirror WITH backrest - QM Tex foamskin Tex
- Osaka - Bench mirror WITH backrest - fabric CAT 0/COM
- Osaka - Bench mirror WITH backrest - fabric CAT 1
- Osaka - Bench mirror WITH backrest - fabric CAT 2

0 = product price in calculation - contact our office for pricing



OSAKA BENCH

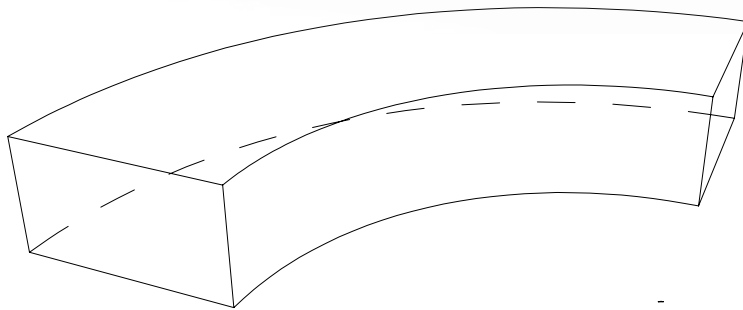
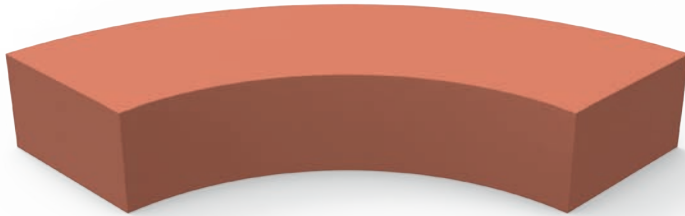

- .....
- Osaka - Bench NO backrest - QM Foam skin
- .....
- Osaka - Bench NO backrest - QM Plus foamskin double
- .....
- Osaka - Bench NO backrest - QM Tex foamskin Tex
- .....
- Osaka - Bench NO backrest - fabric CAT 0/COM
- .....
- Osaka - Bench NO backrest - fabric CAT 1
- .....
- Osaka - Bench NO backrest - fabric CAT 2
- .....

OSAKA BENCH WITH BACKREST

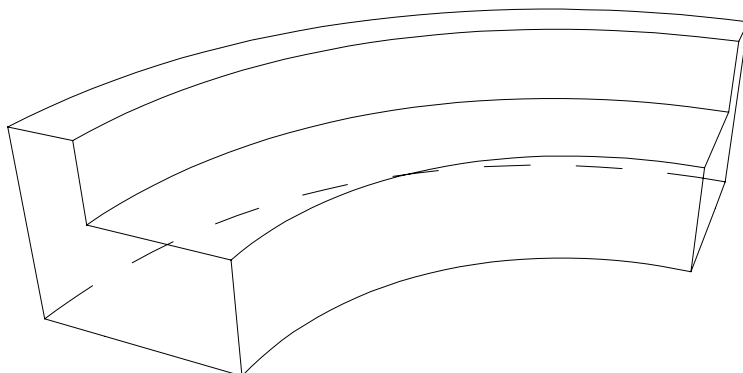
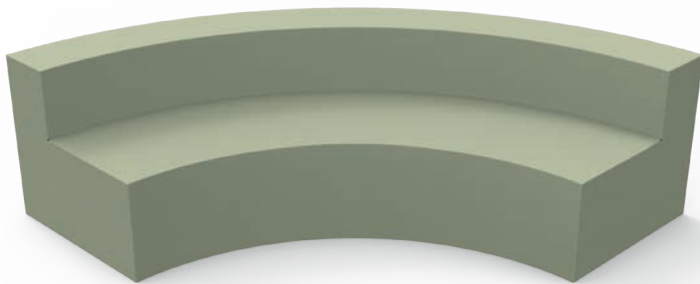

- .....
- Osaka - Bench WITH backrest - QM Plus foamskin double
- .....
- Osaka - Bench WITH backrest - QM Tex foamskin Tex
- .....
- Osaka - Bench WITH backrest - fabric CAT 0/COM
- .....
- Osaka - Bench WITH backrest - fabric CAT 1
- .....
- Osaka - Bench WITH backrest - fabric CAT 2
- .....

0 = product price in calculation - contact our office for pricing

Osaka - Bench NO backrest - QM Foam	QF.OSA.BEN.NOB	€ 2.182	16.364
Osaka - Bench NO backrest - QM Plus	QP.OSA.BEN.NOB	€ 2.394	17.958
Osaka - Bench NO backrest - QM Tex	QT.OSA.BEN.NOB	€ 3.257	24.428
Osaka - Bench NO backrest - fabric CAT 0/COM	QU0.OSA.BEN.NOB	€ 3.199	23.996
Osaka - Bench NO backrest - fabric CAT 1	QU1.OSA.BEN.NOB	€ 3.199	23.996
Osaka - Bench NO backrest - fabric CAT 2	QU2.OSA.BEN.NOB	€ 3.199	23.996
Osaka - Bench WITH backrest - QM Foam	QF.OSA.BEN.BACK	€ 3.184	23.876
Osaka - Bench WITH backrest - QM Plus	QP.OSA.BEN.BACK	€ 3.455	25.915
Osaka - Bench WITH backrest - QM Tex	QT.OSA.BEN.BACK	€ 4.132	30.987
Osaka - Bench WITH backrest - fabric CAT 0/COM	QU0.OSA.BEN.BACK	€ 4.065	30.488
Osaka - Bench WITH backrest - fabric CAT 1	QU1.OSA.BEN.BACK	€ 4.065	30.488
Osaka - Bench WITH backrest - fabric CAT 2	QU2.OSA.BEN.BACK	€ 4.065	30.488
Osaka - Bench WITH backrest & armrest - QM Foam	QF.OSA.BEN.B&A	€ 3.216	24.118
Osaka - Bench WITH backrest & armrest - QM Plus	QP.OSA.BEN.B&A	€ 3.495	26.210
Osaka - Bench WITH backrest & armrest - QM Tex	QT.OSA.BEN.B&A	€ 4.979	37.342
Osaka - Bench WITH backrest & armrest - fabric CAT 0/COM	QU0.OSA.BEN.B&A	€ 4.902	36.763
Osaka - Bench WITH backrest & armrest - fabric CAT 1	QU1.OSA.BEN.B&A	€ 4.902	36.763
Osaka - Bench WITH backrest & armrest - fabric CAT 2	QU2.OSA.BEN.B&A	€ 4.902	36.763
Osaka - Bench mirror WITH backrest - QM Foam	QF.OSA.MIRB.BACK	€ 4.971	37.284
Osaka - Bench mirror WITH backrest - QM Plus	QP.OSA.MIRB.BACK	€ 5.387	40.404
Osaka - Bench mirror WITH backrest - QM Tex	QT.OSA.MIRB.BACK	€ 7.416	55.619
Osaka - Bench mirror WITH backrest - fabric CAT 0/COM	QU0.OSA.MIRB.BACK	€ 7.311	54.831
Osaka - Bench mirror WITH backrest - fabric CAT 1	QU1.OSA.MIRB.BACK	€ 7.311	54.831
Osaka - Bench mirror WITH backrest - fabric CAT 2	QU2.OSA.MIRB.BACK	€ 7.311	54.831



# PENTAGON

DESIGN THOMAS TRITSCH

2007



*Quinze & milan*

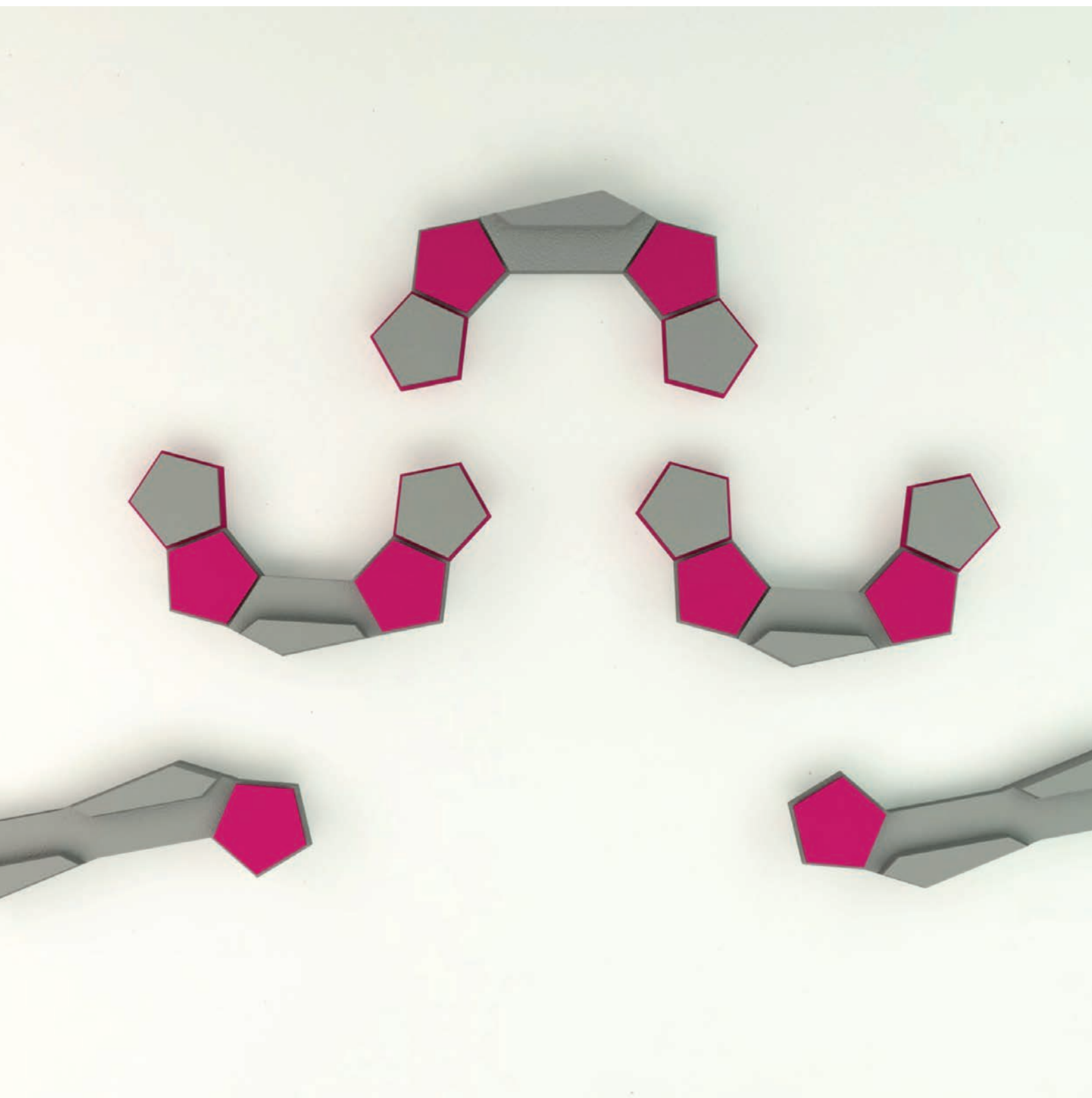

0 = product price in calculation - contact our office for pricing

# PENTAGON

DESIGN THOMAS TRITSCH

2007



*Quinze & milan*

## STEAMSHIP

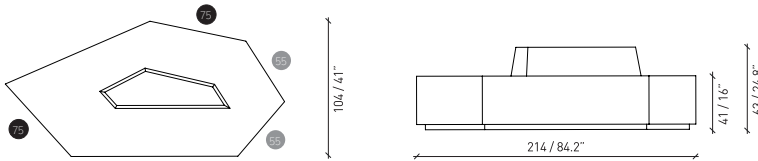

- Pentagon Steamship QM Foam skin
- Pentagon Steamship QM Plus foamskin double
- Pentagon Steamship QM Tex foamskin Tex
- Pentagon Steamship QM CAT 1
- Pentagon Steamship QM CAT 2
- Pentagon Steamship QM CAT 0/COM

## SOFA SMALL

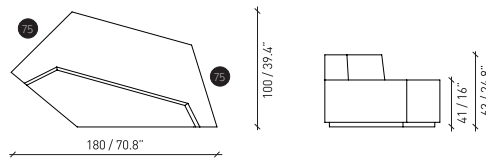

- Pentagon sofa small QM Foam skin
- Pentagon sofa small QM Plus foamskin double
- Pentagon sofa small QM Tex foamskin Tex
- Pentagon sofa small QM CAT 1
- Pentagon sofa small QM CAT 2
- Pentagon sofa small QM CAT 0/COM

## SOFA LARGE

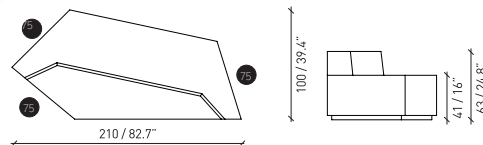

- Pentagon sofa Large QM Foam skin
- Pentagon sofa Large QM Plus foamskin double
- Pentagon sofa Large QM Tex foamskin Tex
- Pentagon sofa Large QM CAT 1
- Pentagon sofa Large QM CAT 2
- Pentagon sofa Large QM CAT 0/COM

## LINKING PIECE

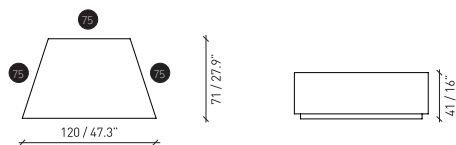
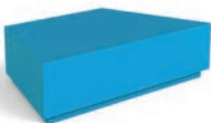

- Pentagon linking piece QM Foam skin
- Pentagon linking piece QM Plus foamskin double
- Pentagon linking piece QM Tex foamskin Tex
- Pentagon linking piece QM CAT 1
- Pentagon linking piece QM CAT 2
- Pentagon linking piece QM CAT 0/COM

0 = product price in calculation - contact our office for pricing

Pentagon pouf 35 QM FOAM	QF.PEN.POU.35	€ 447	3.352
Pentagon pouf 35 QM PLUS	QP.PEN.POU.35	€ 505	3.788
Pentagon pouf 35 QM TEX	QT.PEN.POU.35	€ 944	7.080
Pentagon pouf 35 QM CAT 1	QU1.PEN.POU.35	€ 643	4.822
Pentagon pouf 35 QM CAT 2	QU2.PEN.POU.35	€ 858	6.436
Pentagon pouf 35 QM CAT 0/COM	QU0.PEN.POU.35	€ 703	5.271
Pentagon base 55 + top 55 QM FOAM	QF.PEN.55	€ 1.581	11.859
Pentagon base 55 + top 55 QM PLUS	QP.PEN.55	€ 1.745	13.088
Pentagon base 55 + top 55 QM TEX	QT.PEN.55	€ 2.738	20.533
Pentagon base 55 + top 55 QM CAT 1	QU1.PEN.55	€ 1.706	12.794
Pentagon base 55 + top 55 QM CAT 2	QU2.PEN.55	€ 2.356	17.667
Pentagon base 55 + top 55 QM CAT 0/COM	QU0.PEN.55	€ 1.791	13.435
Pentagon base 75 + top 75 QM FOAM	QF.PEN.75	€ 2.642	19.818
Pentagon base 75 + top 75 QM PLUS	QP.PEN.75	€ 2.917	21.880
Pentagon base 75 + top 75 QM TEX	QT.PEN.75	€ 3.399	25.493
Pentagon base 75 + top 75 QM CAT 1	QU1.PEN.75	€ 2.167	16.252
Pentagon base 75 + top 75 QM CAT 2	QU2.PEN.75	€ 3.056	22.920
Pentagon base 75 + top 75 QM CAT 0/COM	QU0.PEN.75	€ 2.209	16.571
Pentagon Steamship QM FOAM	QF.PEN.STEA	€ 3.576	26.822
Pentagon Steamship QM PLUS	QP.PEN.STEA	€ 3.864	28.984
Pentagon Steamship QM TEX	QT.PEN.STEA	€ 5.857	43.928
Pentagon Steamship QM CAT 1	QU1.PEN.STEA	€ 4.052	30.392
Pentagon Steamship QM CAT 2	QU2.PEN.STEA	€ 5.284	39.627
Pentagon Steamship QM CAT 0/COM	QU0.PEN.STEA	€ 4.437	33.278
Pentagon sofa small QM FOAM	QF.PEN.SOS	€ 3.289	24.664
Pentagon sofa small QM PLUS	QP.PEN.SOS	€ 3.546	26.592
Pentagon sofa small QM TEX	QT.PEN.SOS	€ 5.484	41.130
Pentagon sofa small QM CAT 1	QU1.PEN.SOS	€ 3.864	28.980
Pentagon sofa small QM CAT 2	QU2.PEN.SOS	€ 4.997	37.478
Pentagon sofa small QM CAT 0/COM	QU0.PEN.SOS	€ 4.292	32.187
Pentagon sofa Large QM FOAM	QF.PEN.SOL	€ 3.735	28.011
Pentagon sofa Large QM PLUS	QP.PEN.SOL	€ 4.039	30.294
Pentagon sofa Large QM TEX	QT.PEN.SOL	€ 5.857	43.928
Pentagon sofa Large QM CAT 1	QU1.PEN.SOL	€ 4.052	30.392
Pentagon sofa Large QM CAT 2	QU2.PEN.SOL	€ 5.284	39.627
Pentagon sofa Large QM CAT 0/COM	QU0.PEN.SOL	€ 4.437	33.278
Pentagon linking piece QM FOAM	QF.PEN.LINK	€ 1.289	9.669
Pentagon linking piece QM PLUS	QP.PEN.LINK	€ 1.432	10.739
Pentagon linking piece QM TEX	QT.PEN.LINK	€ 2.085	15.636
Pentagon linking piece QM CAT 1	QU1.PEN.LINK	€ 1.422	10.665

Pentagon linking piece QM CAT 2	QU2.PEN.LINK	€ 1.826	13.692
Pentagon linking piece QM CAT 0/COM	QU0.PEN.LINK	€ 1.430	10.728

# PILOT

DESIGN Patrick Rampelotto & Fritz Pernkopf  
2012



*Quinze & milan*



0 = product price in calculation - contact our office for pricing

#### PILOT COLLECTION

The design of the stool is based on traditional archetypes, their basic simplicity in form and function. The organically shade seat is supported by tapered legs made of oiled European oak. The seat itself is generously proportioned for comfort, its material tactile and contemporary. The ends of the legs are threaded and screwed into the seat, a connection that is both simple and sophisticated given the two very different materials of the joint.

Contact our sales office for more pricing options.



PILOT LOW STOOL

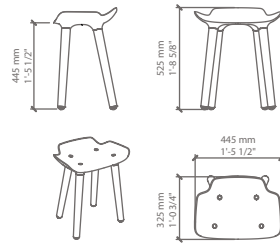

Pilot stool PPE + oak legs

Pilot low stool outdoor PPE + acacia legs



PILOT KITCHEN STOOL

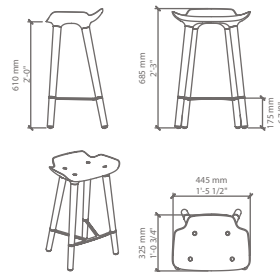

Pilot kitchen stool PPE + oak legs

Pilot kitchen outdoor PPE + acacia legs



PILOT BAR STOOL

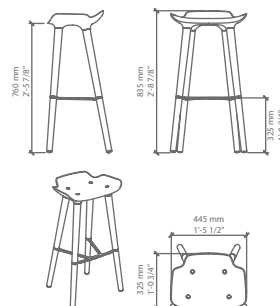

Pilot bar stool PPE + oak legs

Pilot bar stool outdoor PPE + acacia legs

0 = product price in calculation - contact our office for pricing



### PILOT COLLECTION

The design of the stool is based on traditional archetypes, their basic simplicity in form and function. The organically shade seat is supported by tapered legs made of oiled European oak. The seat itself is generously proportioned for comfort, its material tactile and contemporary. The ends of the legs are threaded and screwed into the seat, a connection that is both simple and sophisticated given the two very different materials of the joint.

Contact our sales office for more pricing options.



### PILOT LOW TABLE

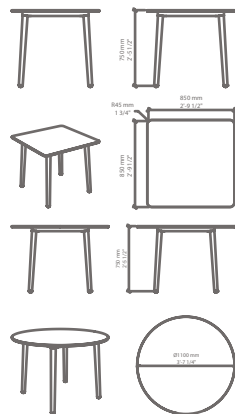

- ..... Pilot table square 85 x 85cm HPL top + oak legs
- ..... Pilot table square 85 x 85cm outdoor HPL top + acacia legs
- ..... Pilot table round diam. 110cm HPL top + oak legs
- ..... Pilot table round diam. 110cm outdoor HPL top + acacia legs



### PILOT KITCHEN/BAR TABLE

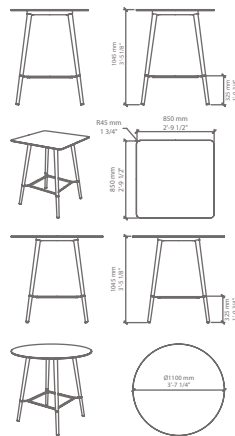

- ..... Pilot kitchen/bar table 85 x 85cm HPL top + oak legs
- ..... Pilot kitchen/bar table 85 x 85cm outdoor HPL top + acacia legs
- ..... Pilot kitchen/bar table round HPL top + oak legs
- ..... Pilot kitchen/bar table round outdoor HPL top + acacia legs

### PILOT SIDE TABLE



- ..... Pilot sidetable low + oak legs
- ..... Pilot sidetable High + oak legs
- ..... Pilot sidetable high/low mpX laminated MPX laminated + oak legs
- ..... Pilot sidetable high/low oak finish + oak legs
- ..... Pilot sidetable high/low oak finish fishbone MPX laminated + oak legs

0 = product price in calculation - contact our office for pricing



Pilot stool PPE + oak legs	PIL.LOW.STO	€ 246	1.842
Pilot kitchen stool PPE + oak legs	PIL.KIT.STO	€ 350	2.628
Pilot bar stool PPE + oak legs	PIL.BAR.STO	€ 379	2.844
Pilot low stool outdoor PPE + acacia legs	PIL.LOW.STO.OUT	€ 253	1.898
Pilot kitchen outdoor PPE + acacia legs	PIL.KIT.STO.OUT	€ 392	2.938
Pilot bar stool outdoor PPE + acacia legs	PIL.BAR.STO.OUT	€ 419	3.145
Pilot table square 85 x 85cm HPL top + oak legs	PIL.LOW.TSQ	€ 709	5.320
Pilot table square 85 x 85cm outdoor HPL top + acacia legs	PIL.LOW.TSQ.OUT	€ 896	6.719
Pilot table round diam. 110Cm HPL top + oak legs	PIL.LOW.TRO	€ 919	6.893
Pilot table round diam. 110Cm outdoor HPL top + acacia legs	PIL.LOW.TRO.OUT	€ 1.110	8.327
Pilot kitchen/bar table 85 x 85cm HPL top + oak legs	PIL.BAR.TSQ	€ 1.111	8.334
Pilot kitchen/bar table 85 x 85cm outdoor HPL top + acacia legs	PIL.BAR.TSQ.OUT	€ 1.335	10.013
Pilot kitchen/bar table round HPL top + oak legs	PIL.BAR.TRO	€ 1.494	11.204
Pilot kitchen/bar table round outdoor HPL top + acacia legs	PIL.BAR.TRO.OUT	€ 1.722	12.917
Pilot sidetable high/low mpX laminated MPX laminated + oak legs	PIL.SAL.HIGH.MPX	€ 811	6.080
Pilot sidetable high/low oak finish + oak legs	PIL.SAL.HIGH.OAK	€ 1.000	7.503
Pilot sidetable high/low oak finish fishbone MPX laminated + oak legs	PIL.SAL.HIGH.OAK F	€ 1.308	9.812
Pilot low table square volkern mat HPL top oak legs	PIL.SAL.LOW.SQ	€ 1.181	8.857
Pilot low table round volkern mat HPL top oak legs	PIL.SAL.LOW.RO	€ 1.408	10.563

# PODIUM SEAT

## DESIGN SAQ

2016



0 = product price in calculation - contact our office for pricing

# PODIUM SEAT

## DESIGN SAQ

### 2016



PODIUM SEAT HIGH backrest



Podiumseat high QM Foam skin

Podiumseat high QM Plus foamskin double

Podiumseat high QM Tex foamskin Tex

PODIUM SEAT LOW backrest

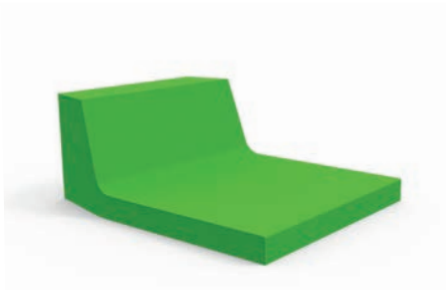

Podiumseat low QM Foam skin

Podiumseat low QM Plus foamskin double

QMTex Podiumseat Low

0 = product price in calculation - contact our office for pricing

Podiumseat low QM FOAM	QF.POD.PSL	€ 449	3.367
Podiumseat low QM PLUS	QP.POD.PSL	€ 513	3.848
Podiumseat high QM FOAM	QF.POD.PSH	€ 543	4.073
Podiumseat high QM PLUS	QP.POD.PSH	€ 615	4.616

PRIMARY  
DESIGN SAQ  
1999



*Quinze & milan*



“Our designs are never the end of a thought process,  
but the beginning of a dialogue, an exchange of ideas.”

Primary Pouf was honored with some of the most prestigious global design awards.

0 = product price in calculation - contact our office for pricing

# PRIMARY DESIGN SAQ 1999



**Quinze & milan**

Stripped to the essence, PRIMARY is the first comprehensive Quinze & Milan collection and a line that deserves to be called a Quinze & Milan classic.

The pieces in this collection include stools with and without legs (POUF 01, POUF 02, POUF 03 AND POUF 04); one-, two-, three- and four-seater settees (SOLO, DUO, TRIO and QUATTRO); and a chaise longue (LOUNGE).

Soft materials and a simple design language are a tried-and-true formula for a happy marriage. Not only did POUF 01 receive a triple Henry van de Velde Award (Belgium, 2001), but the sassy character of this comfortable, water-repellent collection has made it a hit worldwide: look for PRIMARY in prestigious public spaces from San Francisco and Detroit to Cannes and Porto. The pieces in this collection also lend themselves to residential projects.

PRIMARY is also available upholstered in leather and fabric. Custom color or sizes are available upon request.



PRIMARY POUF 01



- Primary Pouf 01 QM Foam skin
- Primary Pouf 01 QM Plus foamskin double
- Primary Pouf 01 QM Tex foamskin Tex
- Primary Pouf 01 QM CAT 1
- Primary Pouf 01 QM CAT 2
- Primary Pouf 01 QM CAT 0/COM



PRIMARY POUF 02

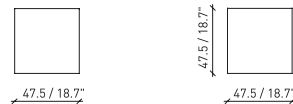

- Primary Pouf 02 QM Foam skin
- Primary Pouf 02 QM Plus foamskin double
- Primary Pouf 02 QM Tex foamskin Tex
- Primary Pouf 02 QM CAT 1
- Primary Pouf 02 QM CAT 2
- Primary Pouf 02 QM CAT 0/COM



PRIMARY POUF 03



- Primary Pouf 03 QM Foam skin
- Primary Pouf 03 QM Plus foamskin double
- Primary Pouf 03 QM Tex foamskin Tex
- Primary Pouf 03 QM CAT 1
- Primary Pouf 03 QM CAT 2
- Primary Pouf 03 QM CAT 0/COM



PRIMARY POUF 04 / NATURAL OAK LEGS



- Primary Pouf 04 QM Foam skin
- Primary Pouf 04 QM Plus foamskin double
- Primary Pouf 04 QM Tex foamskin Tex
- Primary Pouf 04 QM CAT 1
- Primary Pouf 04 QM CAT 2
- Primary Pouf 04 QM CAT 0/COM



PRIMARY POUF 05

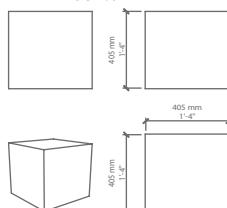

- Primary Pouf 05 QM Foam skin
- Primary Pouf 05 QM Plus foamskin double
- Primary Pouf 05 QM Tex foamskin Tex
- Primary Pouf 05 QM CAT 1
- Primary Pouf 05 QM CAT 2
- Primary Pouf 05 QM CAT 0/COM

0 = product price in calculation - contact our office for pricing

Considering the amount of projects with different sized mirror- and wall solutions (straight back), and with corners more standard solutions have been added. The straight back versions and the corners can easily be placed against the wall.

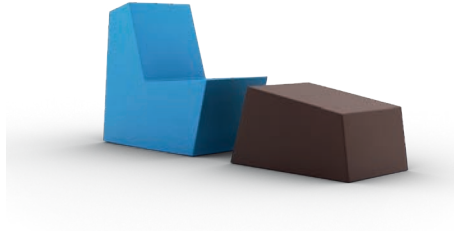

PRIMARY SOLO

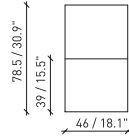
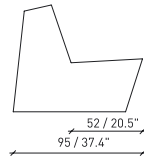

SOLO VARIATIONS



SOLO STRAIGHT BACK



SOLO MIRROR

- Primary Solo QM Foam skin
- Primary Solo QM Plus foamskin double
- Primary Solo QM Tex foamskin Tex
- Primary Solo QM CAT 1
- Primary Solo QM CAT 2
- Primary Solo QM CAT 0/COM
- Primary solo straight back QM Foam skin
- Primary solo straight back QM Plus foamskin double
- Primary solo straight back QM Tex foamskin Tex
- Primary solo straight back QM CAT 1
- Primary solo straight back QM CAT 2
- Primary solo straight back QM CAT 0/COM
- Primary solo mirror QM Foam skin
- Primary solo mirror QM Plus foamskin double
- Primary solo mirror QM Tex foamskin Tex
- Primary solo mirror QM CAT 1
- Primary solo mirror QM CAT 2
- Primary solo mirror QM CAT 0/COM



PRIMARY SOLO OTTOMAN

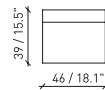

- Primary solo ottoman QM Foam skin
- Primary solo ottoman QM Plus foamskin double
- Primary solo ottoman QM Tex foamskin Tex
- Primary solo ottoman QM CAT 1
- Primary solo ottoman QM CAT 2
- Primary solo ottoman QM CAT 0/COM

PRIMARY DUO

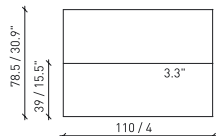
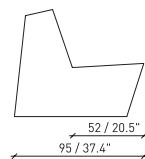

DUO VARIATIONS



DUO STRAIGHT BACK



DUO MIRROR

- Primary duo QM Foam skin
- Primary duo QM Plus foamskin double
- Primary duo QM Tex foamskin Tex
- Primary duo QM CAT 1
- Primary duo QM CAT 2
- Primary duo QM CAT 0/COM
- Primary duo straight back QM Foam skin
- Primary duo straight back QM Plus foamskin double
- Primary duo straight back QM Tex foamskin Tex
- Primary duo straight back QM CAT 1
- Primary duo straight back QM CAT 2
- Primary duo straight back QM CAT 0/COM
- Primary duo mirror QM Foam skin
- Primary duo mirror QM Plus foamskin double
- Primary duo mirror QM Tex foamskin Tex
- Primary duo mirror QM CAT 1
- Primary duo mirror QM CAT 2
- Primary duo mirror QM CAT 0/COM

0 = product price in calculation - contact our office for pricing

PRIMARY  
DESIGN SAQ  
1999



**Quinze & milan**



PRIMARY TRIO

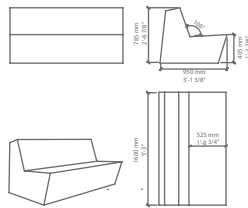

TRIO VARIATIONS

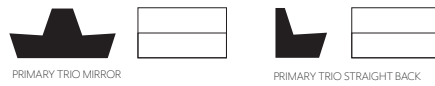

PRIMARY TRIO MIRROR

PRIMARY TRIO STRAIGHT BACK

- ..... Primary trio QM Foam skin
- ..... Primary trio QM Plus foamskin double
- ..... Primary trio QM Tex foamskin Tex
- ..... Primary trio QM CAT 1
- ..... Primary trio QM CAT 2
- ..... Primary trio QM CAT 0/COM
- ..... Primary trio straight back QM Foam skin
- ..... Primary trio straight back QM Plus foamskin double
- ..... Primary trio straight back QM Tex foamskin Tex
- ..... Primary trio straight back QM CAT 1
- ..... Primary trio straight back QM CAT 2
- ..... Primary trio straight back QM CAT 0/COM
- ..... Primary trio mirror QM Foam skin
- ..... Primary trio mirror QM Plus foamskin double
- ..... Primary trio mirror QM Tex foamskin Tex
- ..... Primary trio mirror QM CAT 1
- ..... Primary trio mirror QM CAT 2
- ..... Primary trio mirror QM CAT 0/COM



PRIMARY QUATTRO

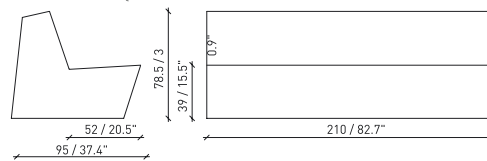

QUATTRO VARIATIONS

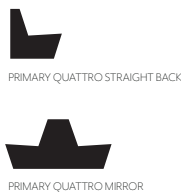

PRIMARY QUATTRO STRAIGHT BACK

PRIMARY QUATTRO MIRROR

- ..... Primary quattro QM Foam skin
- ..... Primary quattro QM Plus foamskin double
- ..... Primary quattro QM Tex foamskin Tex
- ..... Primary quattro QM CAT 1
- ..... Primary quattro QM CAT 2
- ..... Primary quattro QM CAT 0/COM
- ..... Primary quattro straight back QM Foam skin
- ..... Primary quattro straight back QM Plus foamskin double
- ..... Primary quattro straight back QM Tex foamskin Tex
- ..... Primary quattro straight back QM CAT 1
- ..... Primary quattro straight back QM CAT 2
- ..... Primary quattro straight back QM CAT 0/COM
- ..... Primary quattro mirror QM Foam skin
- ..... Primary quattro mirror QM Plus foamskin double
- ..... Primary quattro mirror QM Tex foamskin Tex
- ..... Primary quattro mirror QM CAT 1
- ..... Primary quattro mirror QM CAT 2
- ..... Primary quattro mirror QM CAT 0/COM



PRIMARY LOUNGE

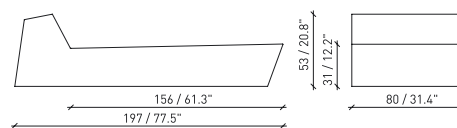

- ..... Primary lounge QM Foam skin
- ..... Primary lounge QM Plus foamskin double
- ..... Primary lounge QM Tex foamskin Tex
- ..... Primary lounge QM CAT 1
- ..... Primary lounge QM CAT 2
- ..... Primary lounge QM CAT 0/COM

0 = product price in calculation - contact our office for pricing



Primary Pouf 01	QM FOAM	QF.PRI.P01	€ 333	2.499
Primary Pouf 01	QM PLUS	QP.PRI.P01	€ 368	2.762
Primary Pouf 01	QM TEX	QT.PRI.P01	€ 660	4.950
Primary Pouf 01	QM CAT 1	QU1.PRI.P01	€ 536	4.020
Primary Pouf 01	QM CAT 2	QU2.PRI.P01	€ 634	4.757
Primary Pouf 01	QM CAT 0/COM	QU0.PRI.P01	€ 493	3.699
Primary Pouf 02	QM FOAM	QF.PRI.P02	€ 457	3.427
Primary Pouf 02	QM PLUS	QP.PRI.P02	€ 526	3.948
Primary Pouf 02	QM TEX	QT.PRI.P02	€ 634	4.752
Primary Pouf 02	QM CAT 1	QU1.PRI.P02	€ 649	4.868
Primary Pouf 02	QM CAT 2	QU2.PRI.P02	€ 806	6.048
Primary Pouf 02	QM CAT 0/COM	QU0.PRI.P02	€ 581	4.356
Primary Pouf 03	QM FOAM	QF.PRI.P03	€ 288	2.162
Primary Pouf 03	QM PLUS	QP.PRI.P03	€ 333	2.497
Primary Pouf 03	QM TEX	QT.PRI.P03	€ 670	5.024
Primary Pouf 03	QM CAT 1	QU1.PRI.P03	€ 506	3.795
Primary Pouf 03	QM CAT 2	QU2.PRI.P03	€ 605	4.534
Primary Pouf 03	QM CAT 0/COM	QU0.PRI.P03	€ 463	3.476
Primary Pouf 04	QM FOAM	QF.PRI.P04	€ 610	4.577
Primary Pouf 04	QM PLUS	QP.PRI.P04	€ 645	4.839
Primary Pouf 04	QM TEX	QT.PRI.P04	€ 940	7.049
Primary Pouf 04	QM CAT 1	QU1.PRI.P04	€ 793	5.944
Primary Pouf 04	QM CAT 2	QU2.PRI.P04	€ 891	6.681
Primary Pouf 04	QM CAT 0/COM	QU0.PRI.P04	€ 750	5.623
Primary Pouf 05	QM FOAM	QF.PRI.P05	€ 308	2.310
Primary Pouf 05	QM PLUS	QP.PRI.P05	€ 357	2.681
Primary Pouf 05	QM TEX	QT.PRI.P05	€ 724	5.427
Primary Pouf 05	QM CAT 1	QU1.PRI.P05	€ 563	4.220
Primary Pouf 05	QM CAT 2	QU2.PRI.P05	€ 720	5.400
Primary Pouf 05	QM CAT 0/COM	QU0.PRI.P05	€ 494	3.706
Primary Solo	QM FOAM	QF.PRI.SOL	€ 863	6.472
Primary Solo	QM PLUS	QP.PRI.SOL	€ 986	7.396
Primary Solo	QM TEX	QT.PRI.SOL	€ 1.346	10.095
Primary Solo	QM CAT 1	QU1.PRI.SOL	€ 874	6.554
Primary Solo	QM CAT 2	QU2.PRI.SOL	€ 1.071	8.030
Primary Solo	QM CAT 0/COM	QU0.PRI.SOL	€ 788	5.913
Primary solo straight back	QM FOAM	QF.PRI.SOL.STB	€ 864	6.483
Primary solo straight back	QM PLUS	QP.PRI.SOL.STB	€ 986	7.394
Primary solo straight back	QM TEX	QT.PRI.SOL.STB	€ 1.514	11.356
Primary solo straight back	QM CAT 1	QU1.PRI.SOL.STB	€ 1.047	7.854

Primary solo straight back QM CAT 2	QU2.PRI.SOL.STB	€ 1.244	9.329
Primary solo straight back QM CAT 0/COM	QU0.PRI.SOL.STB	€ 962	7.213
Primary solo mirror QM FOAM	QF.PRI.SOL.MIR	€ 1.684	12.629
Primary solo mirror QM PLUS	QP.PRI.SOL.MIR	€ 1.891	14.182
Primary solo mirror QM TEX	QT.PRI.SOL.MIR	€ 2.423	18.170
Primary solo mirror QM CAT 1	QU1.PRI.SOL.MIR	€ 1.605	12.041
Primary solo mirror QM CAT 2	QU2.PRI.SOL.MIR	€ 1.881	14.106
Primary solo mirror QM CAT 0/COM	QU0.PRI.SOL.MIR	€ 1.486	11.144
Primary solo ottoman QM FOAM	QF.PRI.SOT	€ 484	3.628
Primary solo ottoman QM PLUS	QP.PRI.SOT	€ 555	4.165
Primary solo ottoman QM TEX	QT.PRI.SOT	€ 1.077	8.080
Primary solo ottoman QM CAT 1	QU1.PRI.SOT	€ 799	5.991
Primary solo ottoman QM CAT 2	QU2.PRI.SOT	€ 917	6.875
Primary solo ottoman QM CAT 0/COM	QU0.PRI.SOT	€ 748	5.607
Primary duo QM FOAM	QF.PRI.DUO	€ 1.749	13.115
Primary duo QM PLUS	QP.PRI.DUO	€ 1.978	14.832
Primary duo QM TEX	QT.PRI.DUO	€ 2.638	19.785
Primary duo QM CAT 1	QU1.PRI.DUO	€ 1.755	13.164
Primary duo QM CAT 2	QU2.PRI.DUO	€ 2.109	15.820
Primary duo QM CAT 0/COM	QU0.PRI.DUO	€ 1.601	12.010
Primary duo straight back QM FOAM	QF.PRI.DUO.SB	€ 1.301	9.761
Primary duo straight back QM PLUS	QP.PRI.DUO.SB	€ 1.529	11.465
Primary duo straight back QM TEX	QT.PRI.DUO.SB	€ 2.631	19.734
Primary duo straight back QM CAT 1	QU1.PRI.DUO.SB	€ 1.755	13.164
Primary duo straight back QM CAT 2	QU2.PRI.DUO.SB	€ 2.109	15.820
Primary duo straight back QM CAT 0/COM	QU0.PRI.DUO.SB	€ 1.601	12.010
Primary duo mirror QM FOAM	QF.PRI.DUO.MIR	€ 3.560	26.702
Primary duo mirror QM PLUS	QP.PRI.DUO.MIR	€ 3.928	29.457
Primary duo mirror QM TEX	QT.PRI.DUO.MIR	€ 4.305	32.287
Primary duo mirror QM CAT 1	QU1.PRI.DUO.MIR	€ 2.896	21.718
Primary duo mirror QM CAT 2	QU2.PRI.DUO.MIR	€ 3.486	26.143
Primary duo mirror QM CAT 0/COM	QU0.PRI.DUO.MIR	€ 2.639	19.794
Primary trio QM FOAM	QF.PRI.TRIO	€ 2.455	18.410
Primary trio QM PLUS	QP.PRI.TRIO	€ 2.762	20.718
Primary trio QM TEX	QT.PRI.TRIO	€ 3.989	29.920
Primary trio QM CAT 1	QU1.PRI.TRIO	€ 2.802	21.014
Primary trio QM CAT 2	QU2.PRI.TRIO	€ 3.293	24.700
Primary trio QM CAT 0/COM	QU0.PRI.TRIO	€ 2.588	19.410
Primary trio straight back QM FOAM	QF.PRI.TRIO.STB	€ 2.527	18.956
Primary trio straight back QM PLUS	QP.PRI.TRIO.STB	€ 2.837	21.275

Primary trio straight back QM TEX	QT.PRI.TRIO.STB	€ 3.996	29.969
Primary trio straight back QM CAT 1	QU1.PRI.TRIO.STB	€ 2.802	21.014
Primary trio straight back QM CAT 2	QU2.PRI.TRIO.STB	€ 3.293	24.700
Primary trio straight back QM CAT 0/COM	QU0.PRI.TRIO.STB	€ 2.588	19.410
Primary trio mirror QM FOAM	QF.PRI.TRIO.MIR	€ 4.674	35.057
Primary trio mirror QM PLUS	QP.PRI.TRIO.MIR	€ 5.145	38.585
Primary trio mirror QM TEX	QT.PRI.TRIO.MIR	€ 5.966	44.743
Primary trio mirror QM CAT 1	QU1.PRI.TRIO.MIR	€ 4.194	31.454
Primary trio mirror QM CAT 2	QU2.PRI.TRIO.MIR	€ 5.040	37.797
Primary trio mirror QM CAT 0/COM	QU0.PRI.TRIO.MIR	€ 3.826	28.697
Primary quattro QM FOAM	QF.PRI.QUA	€ 3.199	23.991
Primary quattro QM PLUS	QP.PRI.QUA	€ 3.594	26.953
Primary quattro QM TEX	QT.PRI.QUA	€ 4.952	37.140
Primary quattro QM CAT 1	QU1.PRI.QUA	€ 3.412	25.593
Primary quattro QM CAT 2	QU2.PRI.QUA	€ 4.002	30.018
Primary quattro QM CAT 0/COM	QU0.PRI.QUA	€ 3.156	23.669
Primary quattro straight back QM FOAM	QF.PRI.QUA.STB	€ 3.279	24.591
Primary quattro straight back QM PLUS	QP.PRI.QUA.STB	€ 3.671	27.530
Primary quattro straight back QM TEX	QT.PRI.QUA.STB	€ 4.939	37.041
Primary quattro straight back QM CAT 1	QU1.PRI.QUA.STB	€ 3.412	25.593
Primary quattro straight back QM CAT 2	QU2.PRI.QUA.STB	€ 4.002	30.018
Primary quattro straight back QM CAT 0/COM	QU0.PRI.QUA.STB	€ 3.156	23.669
Primary quattro mirror QM FOAM	QF.PRI.QUA.MIR	€ 6.229	46.720
Primary quattro mirror QM PLUS	QP.PRI.QUA.MIR	€ 6.860	51.452
Primary quattro mirror QM TEX	QT.PRI.QUA.MIR	€ 7.513	56.348
Primary quattro mirror QM CAT1	QU1.PRI.QUA.MIR	€ 5.081	38.108
Primary quattro mirror QM CAT 2	QU2.PRI.QUA.MIR	€ 6.065	45.484
Primary quattro mirror QM CAT 0/COM	QU0.PRI.QUA.MIR	€ 4.654	34.902
Primary lounge QM FOAM	QF.PRI.LOU	€ 2.023	15.173
Primary lounge QM PLUS	QP.PRI.LOU	€ 2.287	17.150
Primary lounge QM TEX	QT.PRI.LOU	€ 3.896	29.222
Primary lounge QM CAT 1	QU1.PRI.LOU	€ 2.867	21.504
Primary lounge QM CAT 2	QU2.PRI.LOU	€ 3.280	24.602
Primary lounge QM CAT 0/COM	QU0.PRI.LOU	€ 2.688	20.157

QUARTZ  
DESIGN QUINZE & MILAN  
2007



*Quinze & milan*



0 = product price in calculation - contact our office for pricing

# QUARTZ

DESIGN QUINZE & MILAN

2007



**Quinze & milan**

Quinze & Milan tackles geometry once again and has furthered its work on forms and faceting, seeking new effects from the wood and creating a chair whose design is a combination of the past and future. Using the most classic of materials, Quinze & Milan has successfully made an object with a symbolic shape in which the material gains qualities of luminosity.

Quartz is an object of the future that retains the intrinsic value of wood - strong and hard-wearing, comfortable and basic. "We wanted to give the material a different look without however ignoring its natural qualities. The facets give a dynamic and vibrant appeal, while the surface plays with the light, creating a sparkling effect. Just like Quartz.



QUARTZ CHAIR

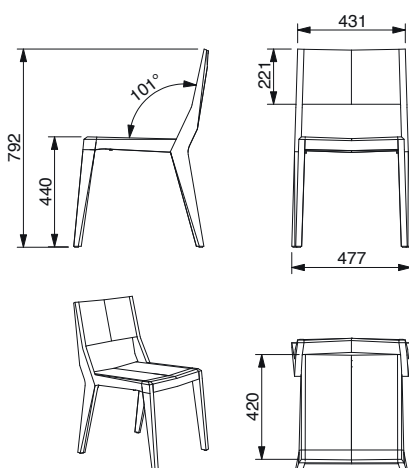

Quartz Chair black

0 = product price in calculation - contact our office for pricing

Quartz Chair black	QUA.CH.BL	€ 480	3.599
--------------------	-----------	-------	-------

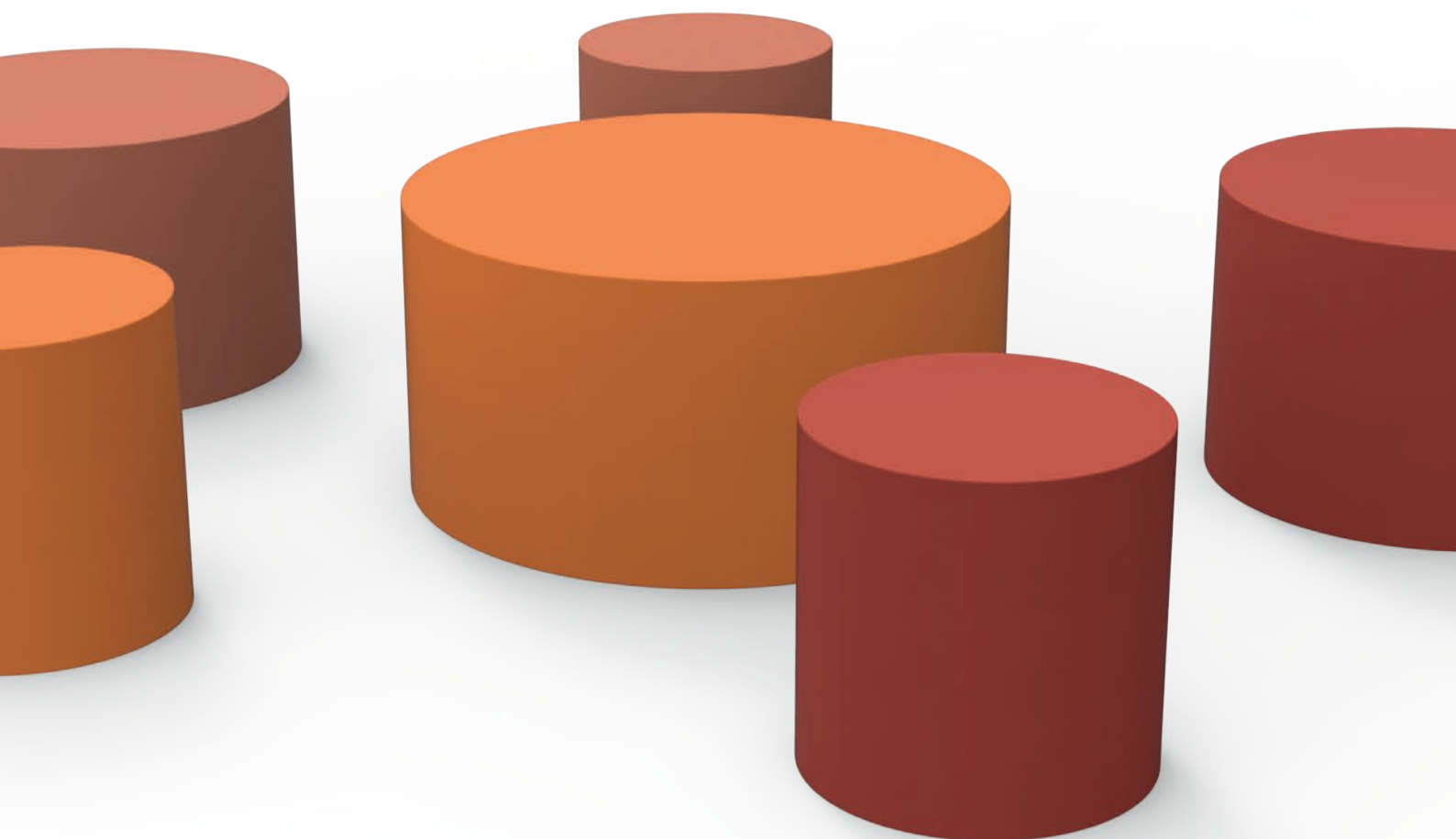

0 = product price in calculation - contact our office for pricing

RONDO IS THE NEW SIZABLE CILLINDAR BLOCK.

Sizable in width, depth and height.

We offer some standard sizes but these blocks can easily be customized in all directions.

We offer some standard sizes for your convenience; keeping a standard seating height from 47,5cm and depth 47,5cm the standard steps are 95 - 142,5 - 190cm

Round 01 starts from w95 x D 47,5 x h 47,5

Round 02 is then w142,5 x d47,5 x h 47,5

Round 03 is w190 x d47,5 x h47,5cm

Off course you can add your specific size to the blocks, keeping the base shape rectangular and seating height at 47,5cm

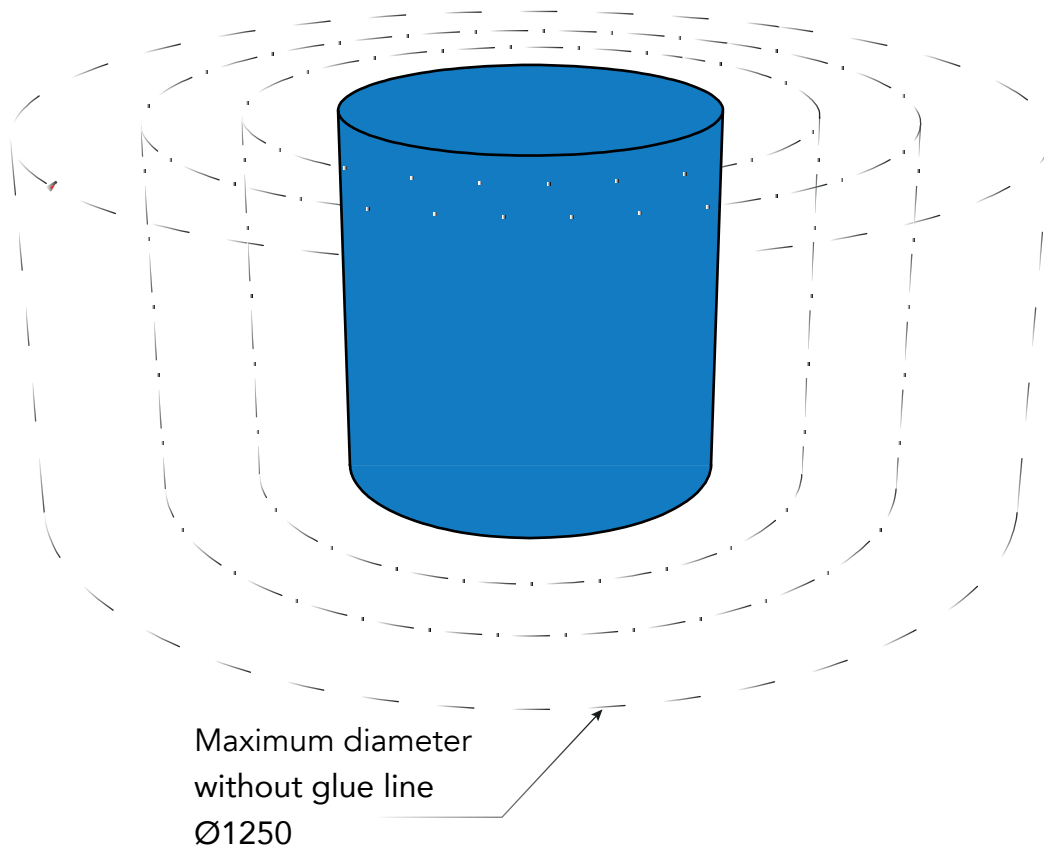





### RONDO 01

Ø 47,5cm  
Height 47,5 cm

Rondo - 01 - QM Foam skin

Rondo - 01 - QM Plus foamskin double

Rondo - 01 - QM Tex foamskin Tex

Rondo - 01 - fabric CAT 0/COM

Rondo - 01 - fabric CAT 1

Rondo - 01 - fabric CAT 2

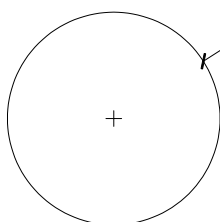
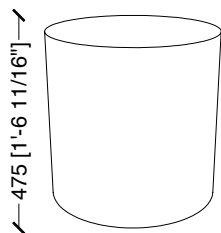

### RONDO 02

Ø 71cm  
Height 47,5cm

Rondo - 02 - QM Foam skin

Rondo - 02 - QM Plus foamskin double

Rondo - 02 - QM Tex foamskin Tex

Rondo - 02 - fabric CAT 0/COM

Rondo - 02 - fabric CAT 1

Rondo - 02 - fabric CAT 2

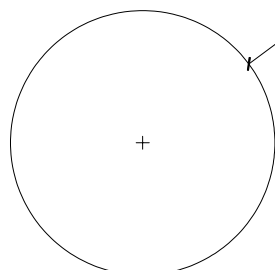
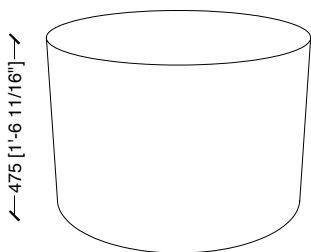

### RONDO 03

Ø 95cm  
Height 47,5cm

Rondo - 03 - QM Foam skin

Rondo - 03 - QM Plus foamskin double

Rondo - 03 - QM Tex foamskin Tex

Rondo - 03 - fabric CAT 0/COM

Rondo - 03 - fabric CAT 1

Rondo - 03 - fabric CAT 2

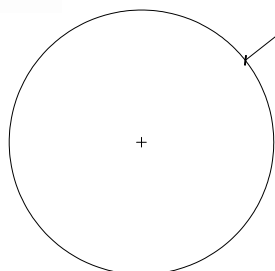
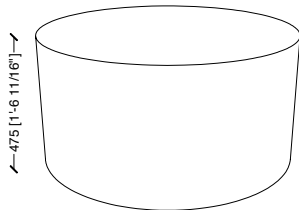

0 = product price in calculation - contact our office for pricing

Rondo - 01 - QM Foam	QF.RON.01.	€ 499	3.739
Rondo - 01 - QM Plus	QP.RON.01.	€ 553	4.149
Rondo - 01 - QM Tex	QT.RON.01.	€ 1.045	7.839
Rondo - 01 - fabric CAT 0/COM	QU0.RON.01.	€ 773	5.795
Rondo - 01 - fabric CAT 1	QU1.RON.01.	€ 824	6.180
Rondo - 01 - fabric CAT 2	QU2.RON.01.	€ 942	7.066
Rondo - 02 - QM Foam	QF.RON.02.	€ 878	6.585
Rondo - 02 - QM Plus	QP.RON.02.	€ 974	7.305
Rondo - 02 - QM Tex	QT.RON.02.	€ 1.766	13.244
Rondo - 02 - fabric CAT 0/COM	QU0.RON.02.	€ 1.308	9.806
Rondo - 02 - fabric CAT 1	QU1.RON.02.	€ 1.372	10.287
Rondo - 02 - fabric CAT 2	QU2.RON.02.	€ 1.519	11.395
Rondo - 03 - QM Foam	QF.RON.03.	€ 1.405	10.536
Rondo - 03 - QM Plus	QP.RON.03	€ 1.550	11.629
Rondo - 03 - QM Tex	QT.RON.03	€ 2.226	16.696
Rondo - 03 - fabric CAT 0/COM	QU0.RON.03	€ 1.552	11.640
Rondo - 03 - fabric CAT 1	QU1.RON.03.	€ 1.680	12.602
Rondo - 03 - fabric CAT 2	QU2.RON.03	€ 1.975	14.814



ROOM 26

DESIGN QUINZE & MILAN

2004



*Quinze & milan*<sup>TM</sup>



0 = product price in calculation - contact our office for pricing

# ROOM 26

DESIGN QUINZE & MILAN

2004



**Quinze & milan™**

ROOM 26 has a look that fuses the familiar and the timeless with 'something different', offering an extensive range of products that can transform an interior into a space that shouts '26' or, when used sparingly, can conjure up a room that barely whispers the word.

Key to the collection is oak, a material playfully combined with fabric, leather or foamskin cushions.

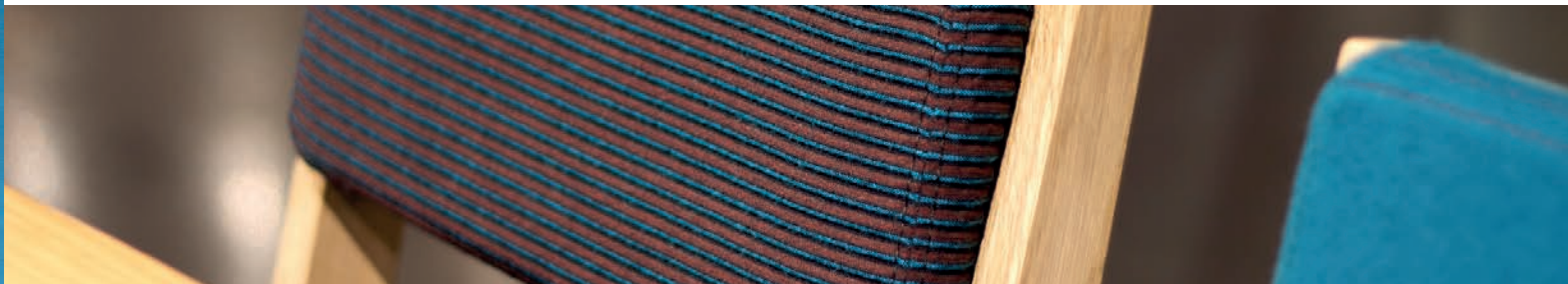

ROOM 26 CHAIR 01

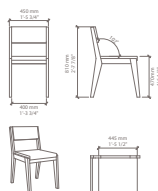

ROOM 26 CHAIR 02

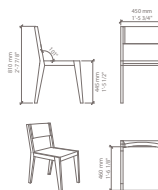

ROOM 26 CHAIR 04

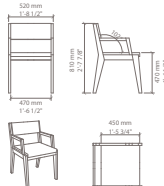

ROOM 26 SEAT 01

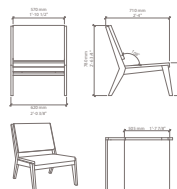

ROOM 26 CHAIR - AMPHI

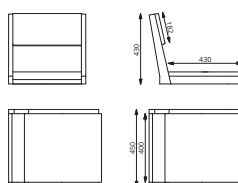

0 = product price in calculation - contact our office for pricing

Room 26 amphi chair ARMRESTS with QM Tex cushions	QT.R26.AMP.ARM	€ 597	4.479
Room 26 chair 01 with QM Tex cushions	QT.R26.C01	€ 613	4.597
Room 26 amphi chair with QM Tex cushions	QT.R26.AMP	€ 583	4.371
QMUpholstery Room 26 amphi chair oak cat 1	QU1.R26.amp	€ 575	4.311

# ROUND CAKE

DESIGN DISSING+WEITLING

2008



*Quinze & milan*



0 = product price in calculation - contact our office for pricing

# ROUND CAKE

DESIGN DISSING+WEITLING

2008



**Quinze & milan**



Round was originally designed for the University Library, a part of the Danish Royal Library, Copenhagen. Round was created to cater for easy socializing in the lounge areas. By composing the various basic elements it is easy to create a relaxed landscape of seating and socializing possibilities. The new humanities faculty library offers the students a well designed, functional library building designed with singular focus on creating the optimum facility based on users' needs. The architects from Dissing+Weitling's project group have liaised closely throughout the entire process with a user group of Royal Library employees.

ROUND CAKE is also available upholstered in leather and fabric.  
Custom color or sizes are available upon request.

## CAKE



Ø 180cm  
Seating height 42cm  
Total height 67cm

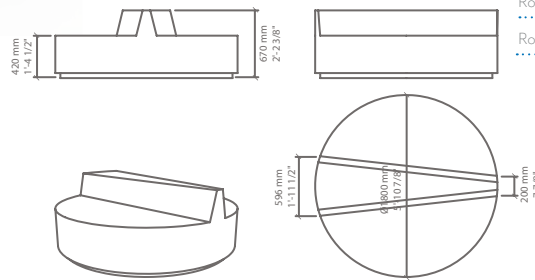

- ..... Round Cake QM Foam skin
- ..... Round Cake QM Plus foamskin double
- ..... Round Cake QM Tex foamskin Tex
- ..... Round Cake QM CAT 1
- ..... Round Cake QM CAT 2
- ..... Round Cake QM CAT 0/COM

## HALF CAKE



Ø 180cm  
Seating height 42cm  
Total height 67cm

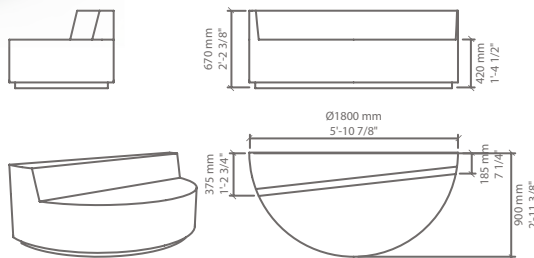

- ..... Round half cake QM Foam skin
- ..... Round half cake QM Plus foamskin double
- ..... Round half cake QM Tex foamskin Tex
- ..... Round half cake QM CAT 1
- ..... Round half cake QM CAT 2
- ..... Round half cake QM CAT 0/COM

0 = product price in calculation - contact our office for pricing



Round Cake	QM FOAM	QF.ROU.CAK	€ 4.916	36.874
Round Cake	QM PLUS	QP.ROU.CAK	€ 5.369	40.271
Round Cake	QM TEX	QT.ROU.CAK	€ 7.068	53.011
Round Cake	QM CAT 1	QU1.ROU.CAK	€ 5.473	41.044
Round Cake	QM CAT 2	QU2.ROU.CAK	€ 6.289	47.166
Round Cake	QM CAT 0/COM	QU0.ROU.CAK	€ 5.118	38.384
Round half cake	QM FOAM	QF.ROU.CAK.HAL	€ 4.003	30.020
Round half cake	QM PLUS	QP.ROU.CAK.HAL	€ 4.358	32.685
Round half cake	QM TEX	QT.ROU.CAK.HAL	€ 5.069	38.017
Round half cake	QM CAT 1	QU1.ROU.CAK.HAL	€ 4.114	30.853
Round half cake	QM CAT 2	QU2.ROU.CAK.HAL	€ 4.468	33.509
Round half cake	QM CAT 0/COM	QU0.ROU.CAK.HAL	€ 3.960	29.699
Round 02	QM FOAM	QF.ROU.R02	€ 2.407	18.052
Round 02	QM PLUS	QP.ROU.R02	€ 2.606	19.542
Round 02	QM TEX	QT.ROU.R02	€ 2.664	19.983
Round 02	QM CAT 1	QU1.ROU.R02	€ 1.958	14.683
Round 02	QM CAT 2	QU2.ROU.R02	€ 2.316	17.368
Round 02	QM CAT 0/COM	QU0.ROU.R02	€ 1.802	13.516
Round 03	QM FOAM	QF.ROU.R03	€ 779	5.844
Round 03	QM PLUS	QP.ROU.R03	€ 871	6.536
Round 03	QM TEX	QT.ROU.R03	€ 1.562	11.714
Round 03	QM CAT 1	QU1.ROU.R03	€ 1.230	9.224
Round 03	QM CAT 2	QU2.ROU.R03	€ 1.396	10.471
Round 03	QM CAT 0/COM	QU0.ROU.R03	€ 1.158	8.683
Round 04	QM FOAM	QF.ROU.R04	€ 940	7.051
Round 04	QM PLUS	QP.ROU.R04	€ 1.039	7.795
Round 04	QM TEX	QT.ROU.R04	€ 1.346	10.093
Round 04	QM CAT 1	QU1.ROU.R04	€ 989	7.420
Round 04	QM CAT 2	QU2.ROU.R04	€ 1.168	8.761
Round 04	QM CAT 0/COM	QU0.ROU.R04	€ 911	6.835
Round 05	QM FOAM	QF.ROU.R05	€ 297	2.231
Round 05	QM PLUS	QP.ROU.R05	€ 339	2.543
Round 05	QM TEX	QT.ROU.R05	€ 684	5.133
Round 05	QM CAT 1	QU1.ROU.R05	€ 534	4.004
Round 05	QM CAT 2	QU2.ROU.R05	€ 609	4.565
Round 05	QM CAT 0/COM	QU0.ROU.R05	€ 501	3.759

# RPBW - Athens collection

DESIGN RENZO PIANO BUILDING WORKSHOP

2016



0 = product price in calculation - contact our office for pricing

# RPBW - Athens collection

DESIGN RENZO PIANO BUILDING WORKSHOP

2016



RPBW

SDC lab worked in close partnership with the staff of the Renzo Piano Building Workshop from Paris in order to develop tailor made furniture.

The result is a number of timeless pieces for special areas in libraries or museums.

Contact our sales office for more pricing options.



## RPBW sofa ottoman

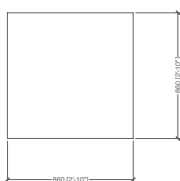

RPBW - Sofa ottoman - QM Foam skin

RPBW - Sofa ottoman - QM Plus foamskin double

RPBW - Sofa ottoman - QM Tex foamskin Tex

RPBW - Sofa ottoman - fabric CAT 1

RPBW - Sofa ottoman - fabric CAT 2

RPBW - Sofa ottoman - fabric CAT 0/COM

## RPBW sofa straight

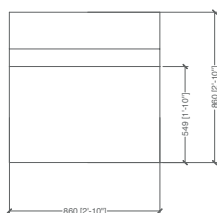
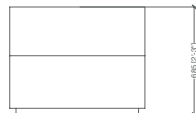
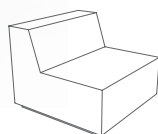
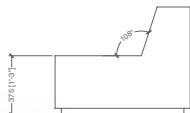

RPBW - Sofa straight - QM Foam skin

RPBW - Sofa straight - QM Plus foamskin double

RPBW - Sofa straight - QM Tex foamskin Tex

RPBW - Sofa straight - fabric CAT 1

RPBW - Sofa straight - fabric CAT 2

RPBW - Sofa straight - fabric CAT 0/COM

## RPBW sofa corner

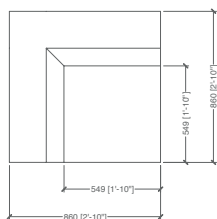
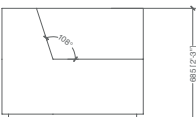
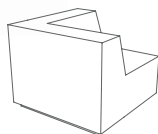
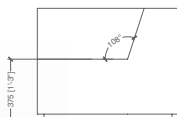
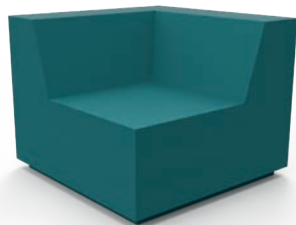

RPBW - Sofa corner - QM Foam skin

RPBW - Sofa corner - QM Plus foamskin double

RPBW - Sofa corner - QM Tex foamskin Tex

RPBW - Sofa corner - fabric CAT 1

RPBW - Sofa corner - fabric CAT 2

RPBW - Sofa corner - fabric CAT 0/COM

0 = product price in calculation - contact our office for pricing

# RPBW - Athens collection

DESIGN RENZO PIANO BUILDING WORKSHOP

2016



RPBW sofa armchair

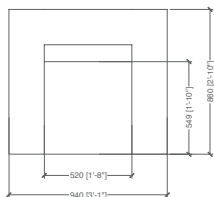
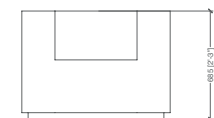
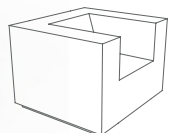
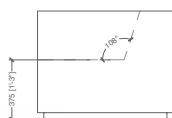
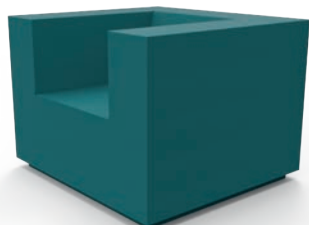

.....  
RPBW - Sofa armchair - QM Foam skin

.....  
RPBW - Sofa armchair - QM Plus foamskin double

.....  
RPBW - Sofa armchair - QM Tex foamskin Tex

.....  
RPBW - Sofa armchair - fabric CAT 1

.....  
RPBW - Sofa armchair - fabric CAT 2

.....  
RPBW - Sofa armchair - fabric CAT 0/COM

RPBW sofa armchair large

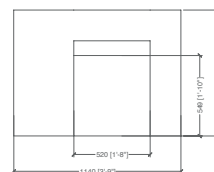
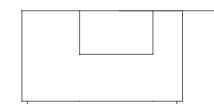
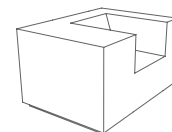
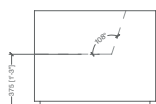
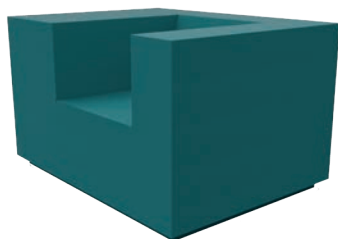

.....  
RPBW - Sofa armchair large - QM Foam skin

.....  
RPBW - Sofa armchair large - QM Plus foamskin double

.....  
RPBW - Sofa armchair large - QM Tex foamskin Tex

.....  
RPBW - Sofa armchair large - fabric CAT 1

.....  
RPBW - Sofa armchair large - fabric CAT 2

.....  
RPBW - Sofa armchair large - fabric CAT 0/COM

0 = product price in calculation - contact our office for pricing

# RPBW - Athens collection

DESIGN RENZO PIANO BUILDING WORKSHOP

2016

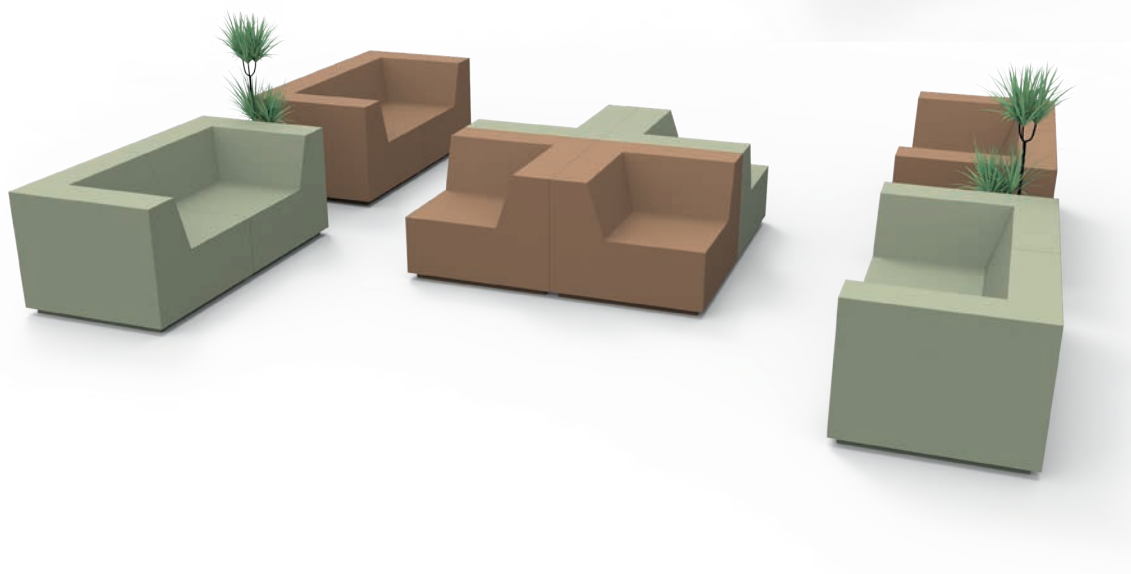
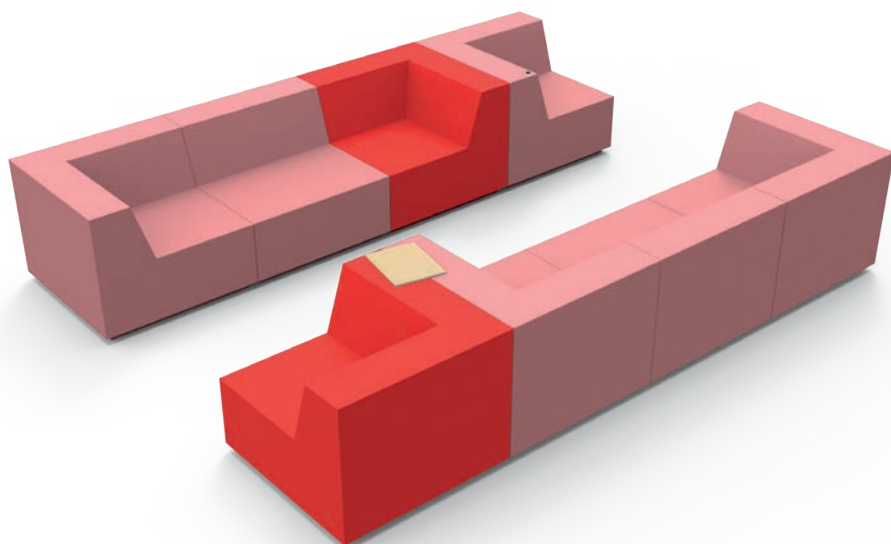

0 = product price in calculation - contact our office for pricing

RPBW - Sofa ottoman - QM Foam	QF.RPBW.SOF.OTT	€ 1.059	7.944
RPBW - Sofa ottoman - QM Plus	QP.RPBW.SOF.OTT	€ 1.196	8.972
RPBW - Sofa ottoman - QM Tex	QT.RPBW.SOF.OTT	€ 1.522	11.418
RPBW - Sofa ottoman - fabric CAT 0/COM	QU0.RPBW.SOF.OTT	€ 1.504	11.280
RPBW - Sofa ottoman - fabric CAT 1	QU1.RPBW.SOF.OTT	€ 1.194	8.954
RPBW - Sofa ottoman - fabric CAT 2	QU2.RPBW.SOF.OTT	€ 1.927	14.455
RPBW - Sofa straight - QM Foam	QF.RPBW.SOF.STR	€ 1.755	13.161
RPBW - Sofa straight - QM Plus	QP.RPBW.SOF.STR	€ 1.923	14.426
RPBW - Sofa straight - QM Tex	QT.RPBW.SOF.STR	€ 2.276	17.068
RPBW - Sofa straight - fabric CAT 0/COM	QU0.RPBW.SOF.STR	€ 2.000	15.001
RPBW - Sofa straight - fabric CAT 1	QU1.RPBW.SOF.STR	€ 2.150	16.123
RPBW - Sofa straight - fabric CAT 2	QU2.RPBW.SOF.STR	€ 2.494	18.704
RPBW - Sofa corner - QM Foam	QF.RPBW.SOF.COR	€ 2.138	16.034
RPBW - Sofa corner - fabric CAT 0/COM	QU0.RPBW.SOF.COR	€ 2.218	16.636
RPBW - Sofa corner - fabric CAT 1	QU1.RPBW.SOF.COR	€ 2.389	17.918
RPBW - Sofa corner - fabric CAT 2	QU2.RPBW.SOF.COR	€ 2.783	20.869
RPBW - Sofa armchair - QM Foam	QF.RPBW.SOF.ARM	€ 2.095	15.714
RPBW - Sofa armchair - QM Tex	QT.RPBW.SOF.ARM	€ 3.244	24.328
RPBW - Sofa armchair - fabric CAT 0/COM	QU0.RPBW.SOF.ARM	€ 2.722	20.413
RPBW - Sofa armchair - fabric CAT 1	QU1.RPBW.SOF.ARM	€ 2.914	21.856
RPBW - Sofa armchair - fabric CAT 2	QU2.RPBW.SOF.ARM	€ 3.357	25.174
RPBW - Sofa armchair large - QM Foam	QF.RPBW.SOF.ARML	€ 2.428	18.206
RPBW - Sofa armchair large - QM Tex	QT.RPBW.SOF.ARML	€ 3.314	24.856
RPBW - Sofa armchair large - fabric CAT 0/COM	QU0.RPBW.SOF.ARML	€ 2.675	20.059
RPBW - Sofa armchair large - fabric CAT 1	QU1.RPBW.SOF.ARML	€ 2.893	21.695
RPBW - Sofa armchair large - fabric CAT 2	QU2.RPBW.SOF.ARML	€ 3.394	25.457

SCONE

DESIGN KAZUKO OKAMOTO

2018

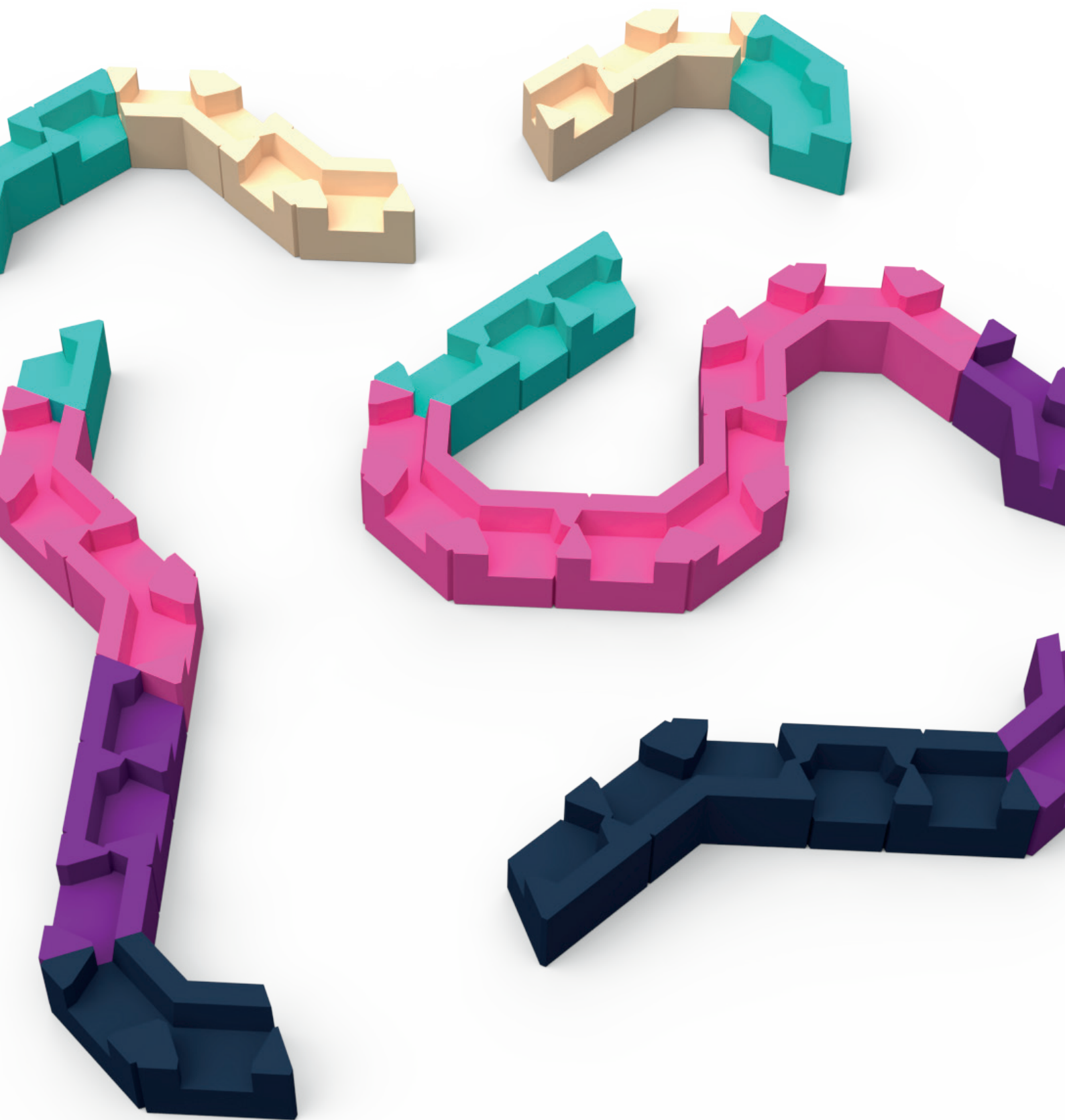

0 = product price in calculation - contact our office for pricing

SCONE is a thrilling modular sofa designed by Kazuko Okamoto, a Japanese designer with her roots in Japan. Scone is a design idea that gives you the possibility to combine, turn, create unexpected twists to your project.

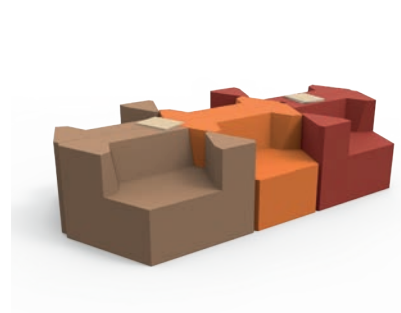
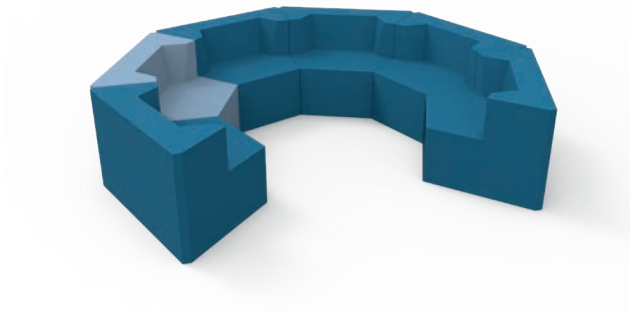

SCONE narrow

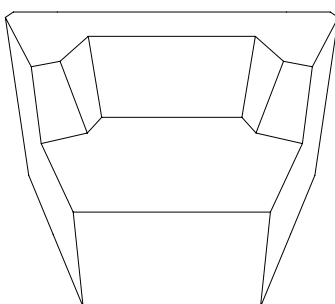

SCONE - narrow no arm - QM Foam skin

SCONE - narrow no arm - QM Plus foamskin double

SCONE wide

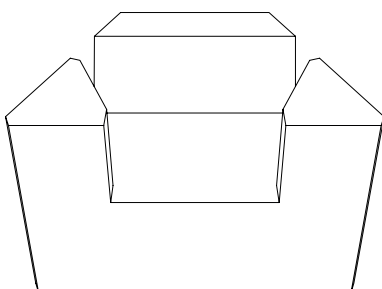
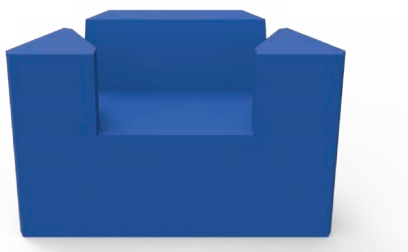

SCONE - wide double arm - QM Foam skin

SCONE - wide double arm - QM Plus foamskin double

SCONE left & right

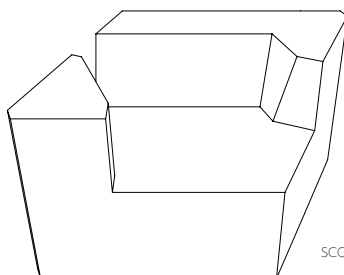

SCONE left

SCONE - left - QM Foam skin

SCONE - left - QM Plus foamskin double

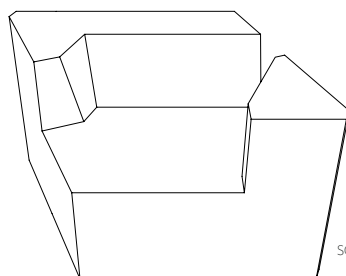
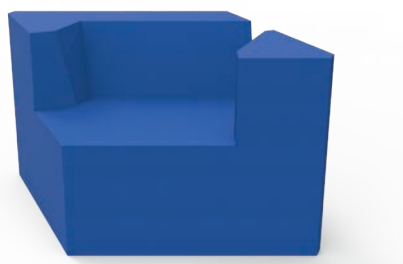

SCONE right

SCONE - right - QM Foam skin

SCONE - right - QM Plus foamskin double

0 = product price in calculation - contact our office for pricing



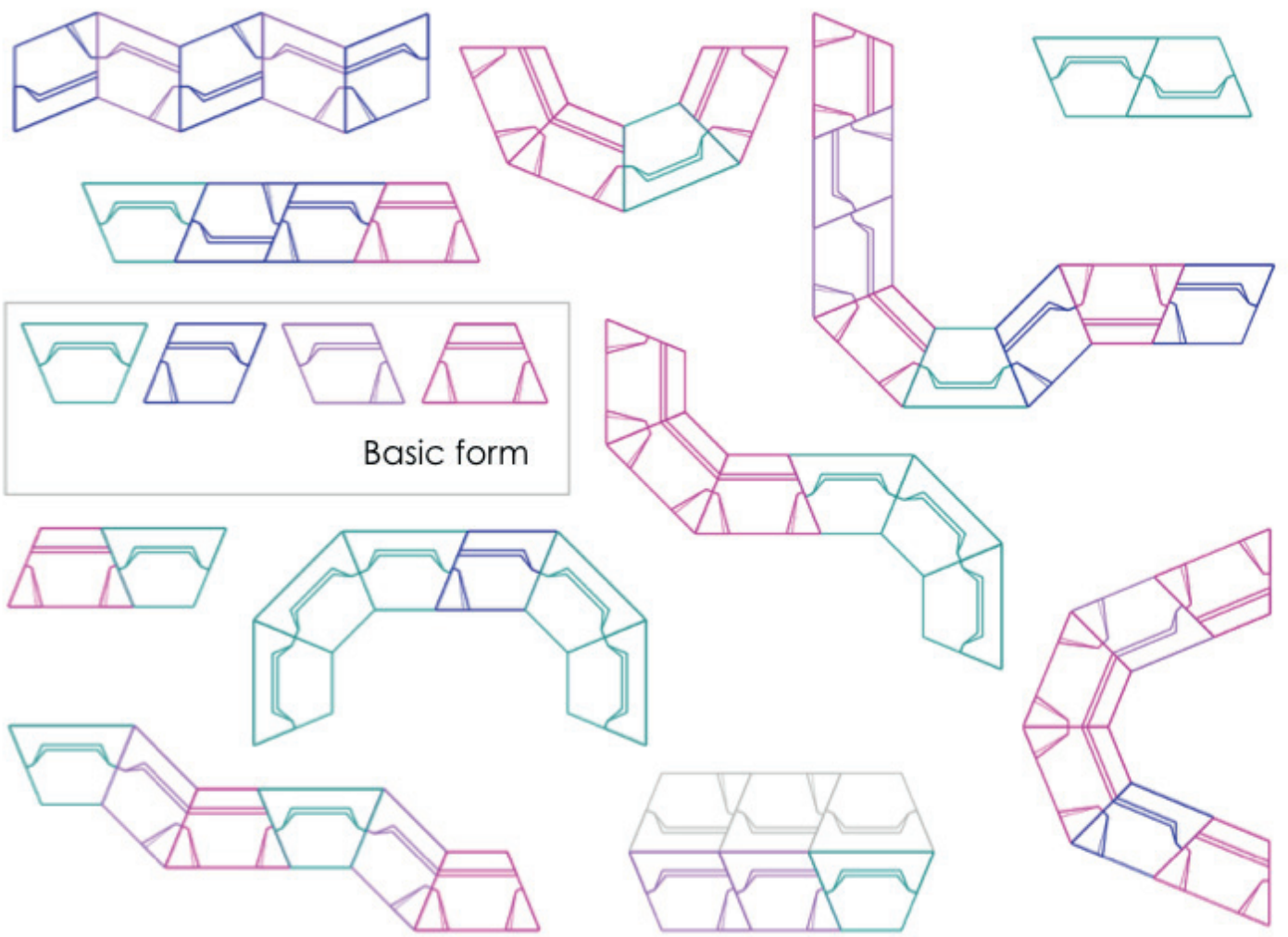
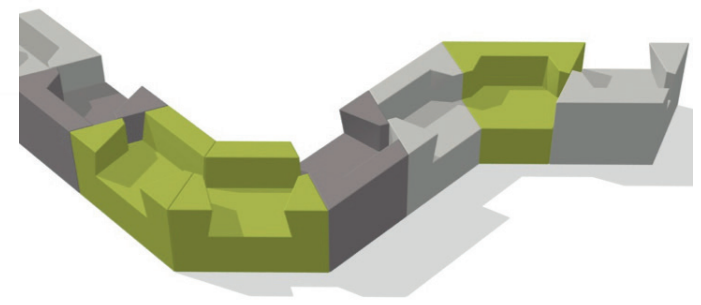
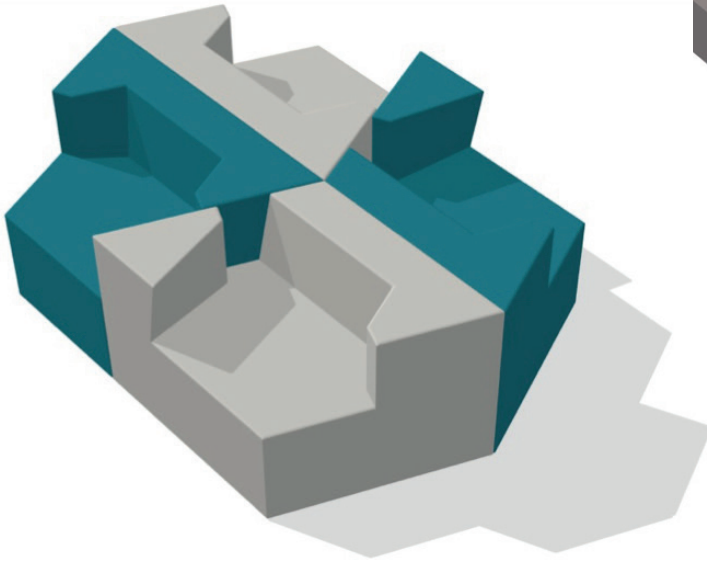

Basic form

0 = product price in calculation - contact our office for pricing

SCONE - wide double arm - QM Foam	QF.SCO.WID.	€ 1.941	14.554
SCONE - wide double arm - QM Plus	QP.SCO.WID.	€ 2.104	15.783
SCONE - wide double arm- QM Tex	QT.SCO.WID.	€ 0	0
SCONE - wide double arm - fabric CAT 0/COM	QU0.SCO.WID.	€ 0	0
SCONE - wide double arm - fabric CAT 1	QU1.SCO.WID.	€ 0	0
SCONE - wide double arm- fabric CAT 2	QU2.SCO.WID.	€ 0	0
SCONE - narrow no arm- QM Foam	QF.SCO.NAR.	€ 2.019	15.139
SCONE - narrow no arm- QM Plus	QP.SCO.NAR.	€ 2.169	16.266
SCONE - narrow no arm- QM Tex	QT.SCO.NAR.	€ 0	0
SCONE - narrow no arm - fabric CAT 0/COM	QU0.SCO.NAR.	€ 0	0
SCONE - narrow no arm- fabric CAT 1	QU1.SCO.NAR.	€ 0	0
SCONE - narrow no arm - fabric CAT 2	QU2.SCO.NAR.	€ 0	0
SCONE - left - QM Foam	QF.SCO.LEF.	€ 2.072	15.540
SCONE - left - QM Plus	QP.SCO.LEF.	€ 2.230	16.723
SCONE - left - QM Tex	QT.SCO.LEF.	€ 0	0
SCONE - left - fabric CAT 0/COM	QU0.SCO.LEF.	€ 0	0
SCONE - left - fabric CAT 1	QU1.SCO.LEF.	€ 0	0
SCONE - left - fabric CAT 2	QU2.SCO.LEF.	€ 0	0
SCONE - right - QM Foam	QF.SCO.RIG.	€ 2.072	15.540
SCONE - right - QM Plus	QP.SCO.RIG.	€ 2.230	16.723
SCONE - right - QM Tex	QT.SCO.RIG.	€ 0	0
SCONE - right - fabric CAT 0/COM	QU0.SCO.RIG.	€ 0	0
SCONE - right - fabric CAT 1	QU1.SCO.RIG.	€ 0	0
SCONE - right - fabric CAT 2	QU2.SCO.RIG.	€ 0	0



PLATFORM  
FOR  
FURNITURE

Blank page with horizontal lines for writing.

SEATTLE CROSS  
DESIGN SCOTT WILSON  
2004



*Quinze & milan*



0 = product price in calculation - contact our office for pricing

# SEATTLE CROSS DESIGN SCOTT WILSON 2004



**Quinze & milan**



OMA (Office for Metropolitan Architecture) commissioned Quinze & Milan to furnish the Seattle Public Library, a project for which the seating system had to comply with the strict standards of the ISDA.

SEATTLE CROSS is also available upholstered in leather and fabric.

Custom color or sizes are available upon request.

## SEATTLE CROSS 01

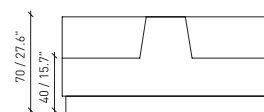
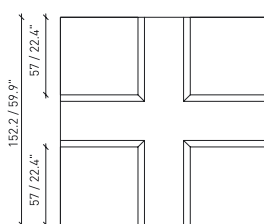
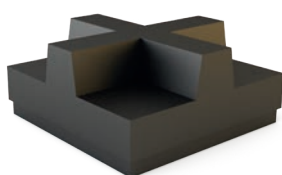

Seattle cross 01 QM Foam skin

Seattle cross 01 QM Plus foamskin double

Seattle cross 01 QM Tex foamskin Tex

Seattle cross 01 QM CAT 1

Seattle cross 01 QM CAT 2

Seattle cross 01 QM CAT 0/COM

## > TOPVIEW VARIATIONS

PRICING OF THESE VARIATIONS IS IDENTICAL AS SEATTLE CROSS 01



02

Seattle cross 02 QM Foam skin

Seattle cross 02 QM Plus foamskin double

Seattle cross 02 QM Tex foamskin Tex

Seattle cross 02 QM CAT 1

Seattle cross 02 QM CAT 2

Seattle cross 02 QM CAT 0/COM

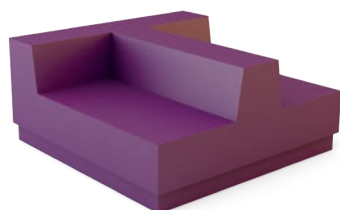

03

Seattle cross 03 QM Foam skin

Seattle cross 03 QM Plus foamskin double

Seattle cross 03 QM Tex foamskin Tex

Seattle cross 03 QM CAT 1

Seattle cross 03 QM CAT 2

Seattle cross 03 QM CAT 0/COM

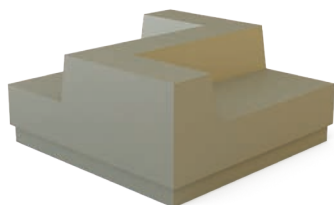

04

Seattle cross 04 QM Foam skin

Seattle cross 04 QM Plus foamskin double

Seattle cross 04 QM Tex foamskin Tex

Seattle cross 04 QM CAT 1

Seattle cross 04 QM CAT 2

Seattle cross 04 QM CAT 0/COM

0 = product price in calculation - contact our office for pricing

Seattle cross 01	QM FOAM	QF.SEA.C01	€ 5.599	41.995
Seattle cross 01	QM PLUS	QP.SEA.C01	€ 6.044	45.331
Seattle cross 01	QM TEX	QT.SEA.C01	€ 6.824	51.183
Seattle cross 01	QM CAT 1	QU1.SEA.C01	€ 4.847	36.353
Seattle cross 01	QM CAT 2	QU2.SEA.C01	€ 5.700	42.747
Seattle cross 01	QM CAT 0/COM	QU0.SEA.C01	€ 4.477	33.574
Seattle cross 02	QM FOAM	QF.SEA.C02	€ 5.069	38.015
Seattle cross 02	QM PLUS	QP.SEA.C02	€ 5.494	41.208
Seattle cross 02	QM TEX	QT.SEA.C02	€ 6.721	50.406
Seattle cross 02	QM CAT 1	QU1.SEA.C02	€ 4.812	36.093
Seattle cross 02	QM CAT 2	QU2.SEA.C02	€ 5.628	42.213
Seattle cross 02	QM CAT 0/COM	QU0.SEA.C02	€ 4.457	33.430
Seattle cross 03	QM FOAM	QF.SEA.C03	€ 5.612	42.088
Seattle cross 03	QM PLUS	QP.SEA.C03	€ 6.059	45.442
Seattle cross 03	QM TEX	QT.SEA.C03	€ 6.838	51.288
Seattle cross 03	QM CAT 1	QU1.SEA.C03	€ 4.852	36.389
Seattle cross 03	QM CAT 2	QU2.SEA.C03	€ 5.709	42.819
Seattle cross 03	QM CAT 0/COM	QU0.SEA.C03	€ 4.479	33.592
Seattle cross 04	QM FOAM	QF.SEA.C04	€ 5.612	42.088
Seattle cross 04	QM PLUS	QP.SEA.C04	€ 6.059	45.442
Seattle cross 04	QM TEX	QT.SEA.C04	€ 6.838	51.288
Seattle cross 04	QM CAT 1	QU1.SEA.C04	€ 4.852	36.389
Seattle cross 04	QM CAT 2	QU2.SEA.C04	€ 5.709	42.819
Seattle cross 04	QM CAT 0/COM	QU0.SEA.C04	€ 4.479	33.592

# SHAPES & CURVES

DESIGN SDC\_lab

2016

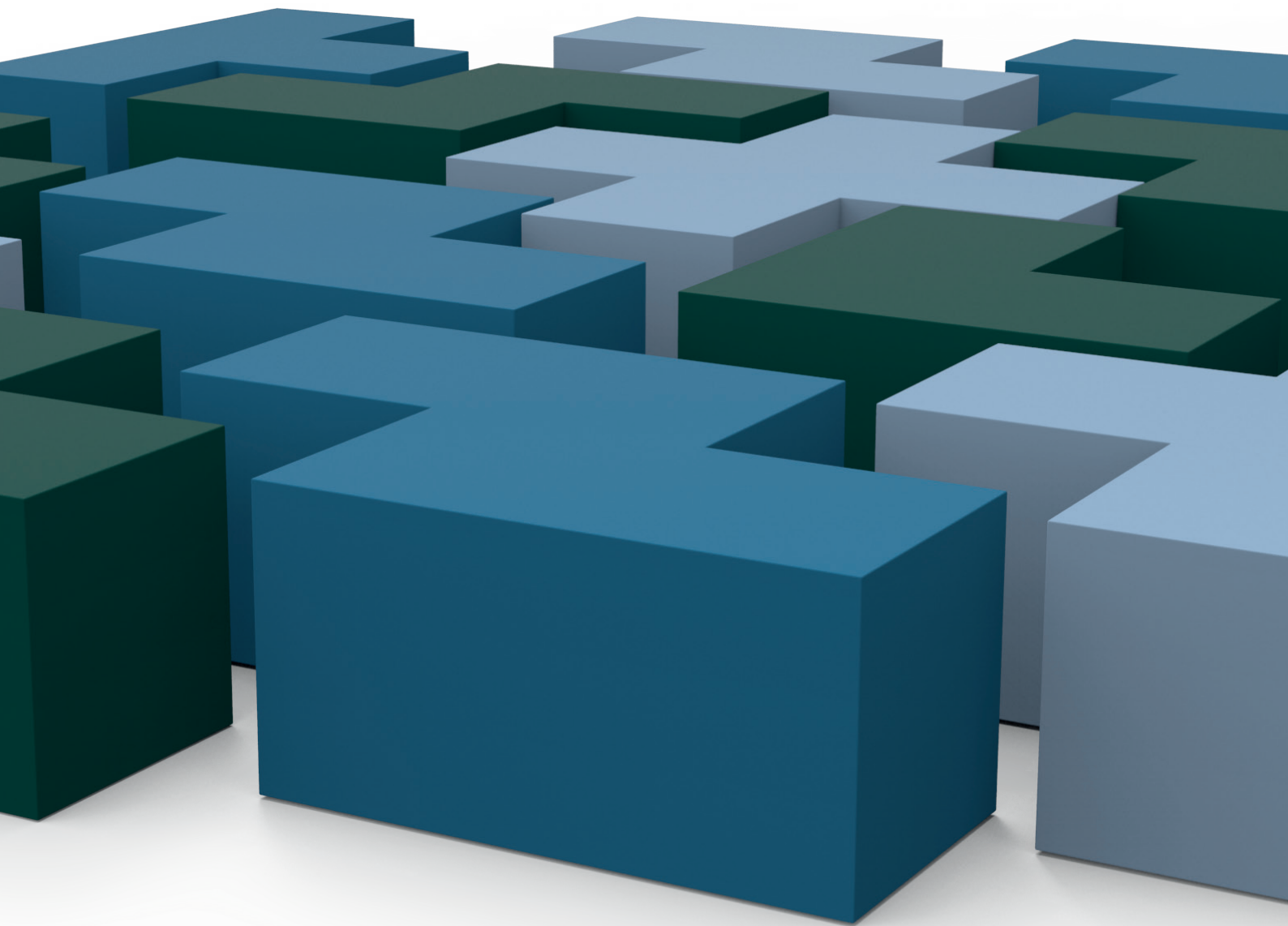

0 = product price in calculation - contact our office for pricing

# SHAPES & CURVES

DESIGN SDC lab

2016



## S SHAPE

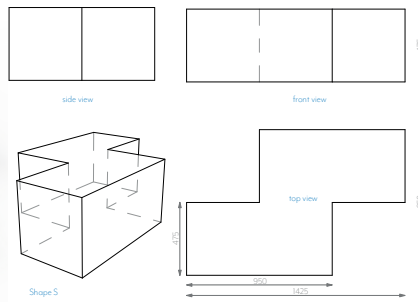
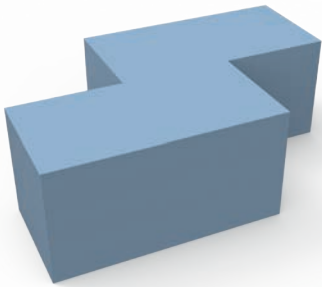

- Shapes - S-shape - QM Foam skin
- Shapes - S-shape - QM Plus foamskin double
- Shapes - S-shape - QM Tex foamskin Tex
- Shapes - S-shape - fabric CAT 1
- Shapes - S-shape - fabric CAT 2
- Shapes - S-shape - fabric CAT 0/COM

## Z SHAPE

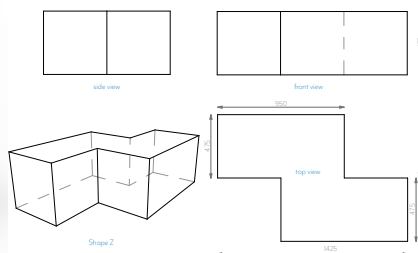
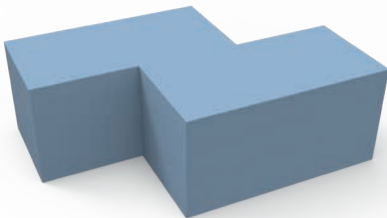

- Shapes - Z-shape - QM Foam skin
- Shapes - Z-shape - QM Plus foamskin double
- Shapes - Z-shape - QM Tex foamskin Tex
- Shapes - Z-shape - fabric CAT 1
- Shapes - Z-shape - fabric CAT 2
- Shapes - Z-shape - fabric CAT 0/COM

## L SHAPE

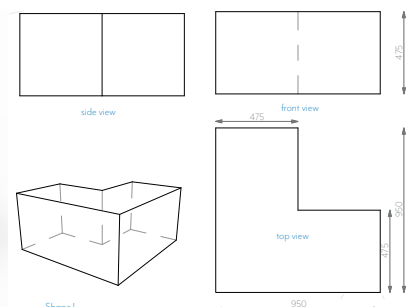
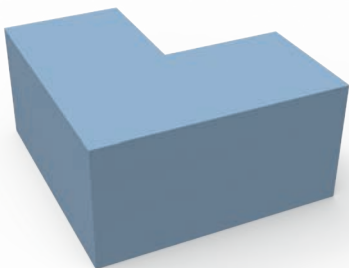

- Shapes - L-shape - QM Foam skin
- Shapes - L-shape - QM Plus foamskin double
- Shapes - L-shape - QM Tex foamskin Tex
- Shapes - L-shape - fabric CAT 1
- Shapes - L-shape - fabric CAT 2
- Shapes - L-shape - fabric CAT 0/COM

## T SHAPE

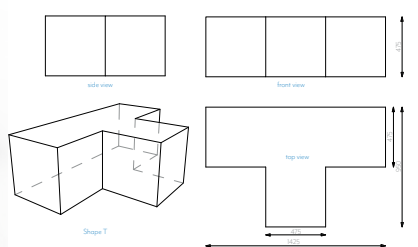
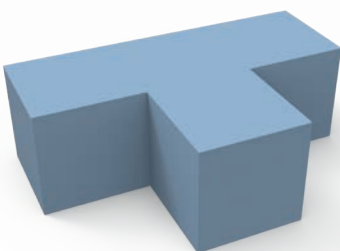

- Shapes - T-shape - QM Foam skin
- Shapes - T-shape - QM Plus foamskin double
- Shapes - T-shape - QM Tex foamskin Tex
- Shapes - T-shape - fabric CAT 1
- Shapes - T-shape - fabric CAT 2
- Shapes - T-shape - fabric CAT 0/COM

## X SHAPE

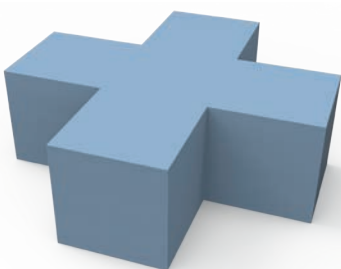

- Shapes - X-shape - QM Foam skin
- Shapes - X-shape - QM Plus foamskin double
- Shapes - X-shape - QM Tex foamskin Tex
- Shapes - X-shape - fabric CAT 1
- Shapes - X-shape - fabric CAT 2
- Shapes - X-shape - fabric CAT 0/COM

0 = product price in calculation - contact our office for pricing



## PENTAGON SHAPE

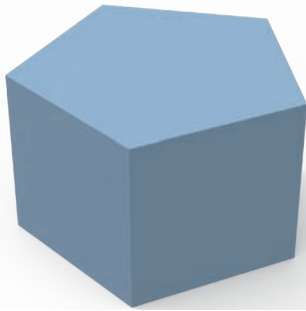

side view

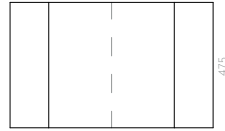

front view

- .....
- ..... Shapes - Pentagon - QM Foam skin
- ..... Shapes - Pentagon - QM Plus foamskin double
- ..... Shapes - Pentagon - QM Tex foamskin Tex
- ..... Shapes - Pentagon - fabric CAT 1
- .....
- ..... Shapes - Pentagon - fabric CAT 2
- ..... Shapes - Pentagon - fabric CAT 0/COM
- .....

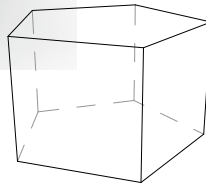

Shape Pentagon

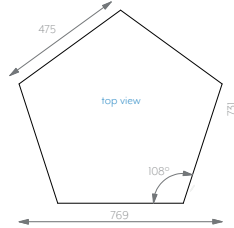

top view

## HEXAGON SHAPE

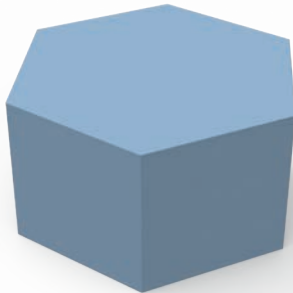

side view

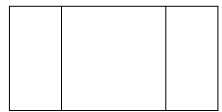

front view

- .....
- ..... Shapes - Hexagon - QM Foam skin
- ..... Shapes - Hexagon - QM Plus foamskin double
- ..... Shapes - Hexagon - QM Tex foamskin Tex
- ..... Shapes - Hexagon - fabric CAT 1
- .....
- ..... Shapes - Hexagon - fabric CAT 2
- ..... Shapes - Hexagon - fabric CAT 0/COM
- .....

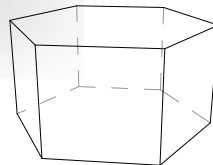

Shape Hexagon

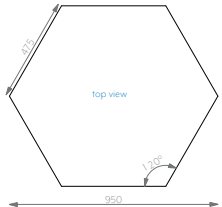

top view

## TRIANGLE SHAPE

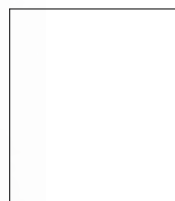
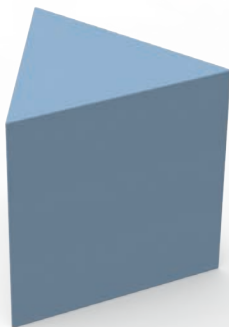

side view

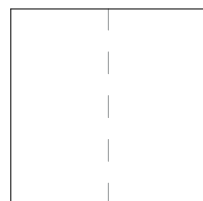

front view

- .....
- ..... Shapes - Triangle - QM Foam skin
- ..... Shapes - Triangle - QM Plus foamskin double
- ..... Shapes - Triangle - QM Tex foamskin Tex
- ..... Shapes - Triangle - fabric CAT 1
- .....
- ..... Shapes - Triangle - fabric CAT 2
- ..... Shapes - Triangle - fabric CAT 0/COM
- .....

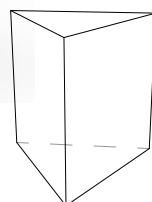

Shape Triangle

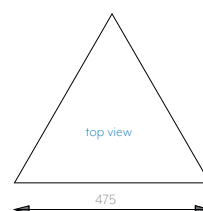

top view

0 = product price in calculation - contact our office for pricing

## CURVE 90

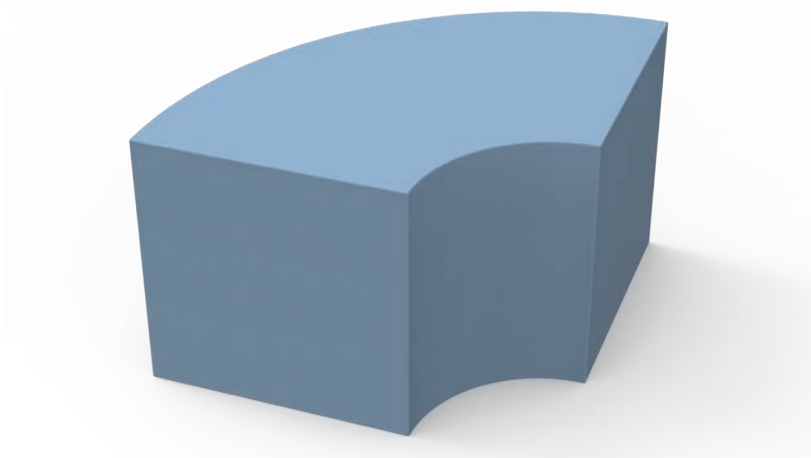

- .....
- ..... Curves - Curve 90 - QM Foam skin
- .....
- ..... Curves - Curve 90 - QM Plus foamskin double
- .....
- ..... Curves - Curve 90 - QM Tex foamskin Tex
- .....
- ..... Curves - Curve 90 - fabric CAT 0/COM
- .....
- ..... Curves - Curve 90 - fabric CAT 1
- .....
- ..... Curves - Curve 90 - fabric CAT 2
- .....

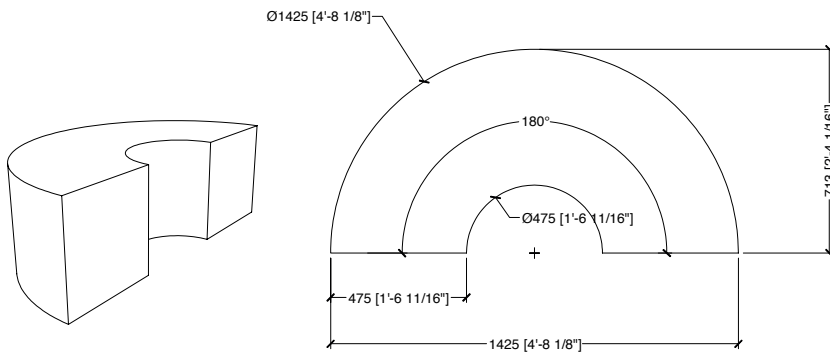

## CURVE 180

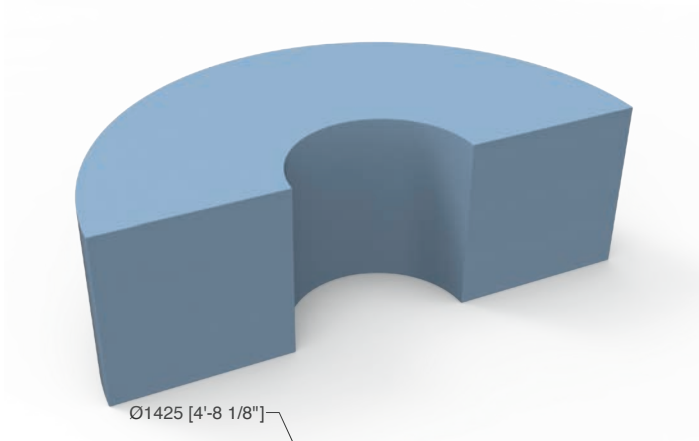

- .....
- ..... Curves - Curve 180 - QM Foam skin
- .....
- ..... Curves - Curve 180 - QM Plus foamskin double
- .....
- ..... Curves - Curve 180 - QM Tex foamskin Tex
- .....
- ..... Curves - Curve 180 - fabric CAT 0/COM
- .....
- ..... Curves - Curve 180 - fabric CAT 1
- .....
- ..... Curves - Curve 180 - fabric CAT 2
- .....

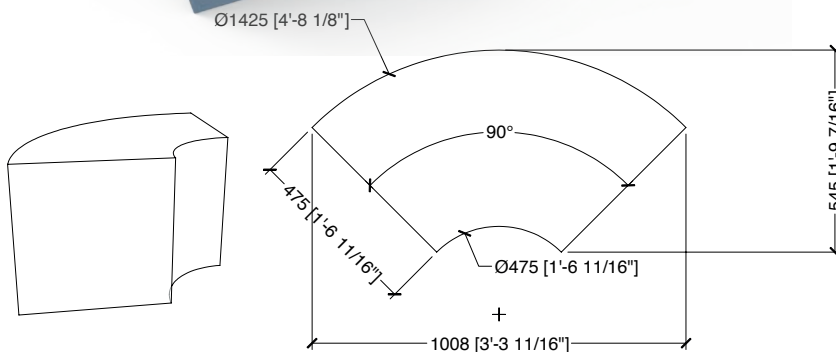

0 = product price in calculation - contact our office for pricing

## CURVE HALF ROUND

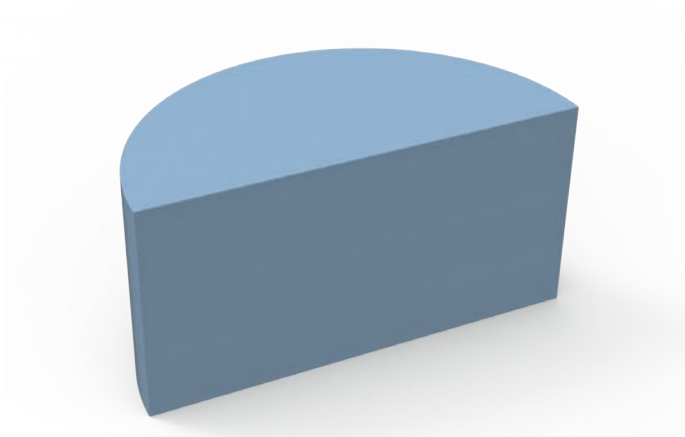

- .....
- ..... Curves - half round - QM Foam skin
- ..... Curves - half round - QM Plus foamskin double
- ..... Curves - half round - QM Tex foamskin Tex
- ..... Curves - half round - fabric CAT 0/COM
- ..... Curves - half round - fabric CAT 1
- ..... Curves - half round - fabric CAT 2
- .....

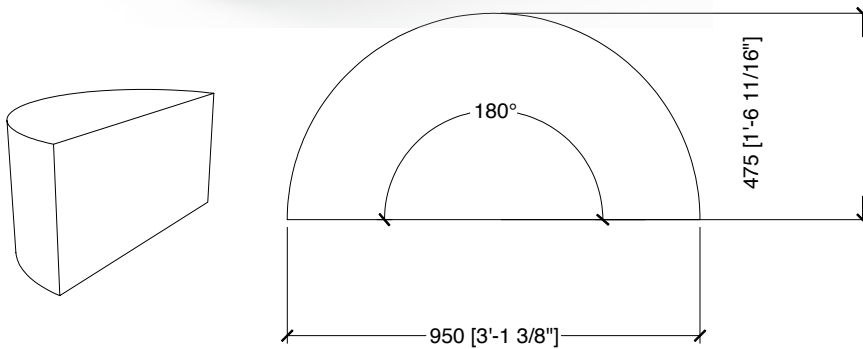

## CURVE QUARTER R

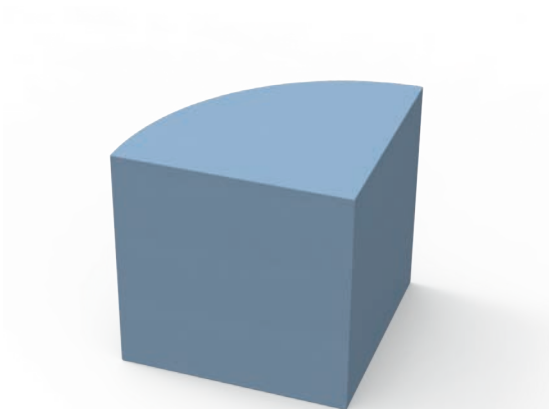

- .....
- ..... Curves - quarter round - QM Foam skin
- ..... Curves - quarter round - QM Plus foamskin double
- ..... Curves - quarter round - QM Tex foamskin Tex
- ..... Curves - quarter round - fabric CAT 0/COM
- ..... Curves - quarter round - fabric CAT 1
- ..... Curves - quarter round - fabric CAT 2
- .....

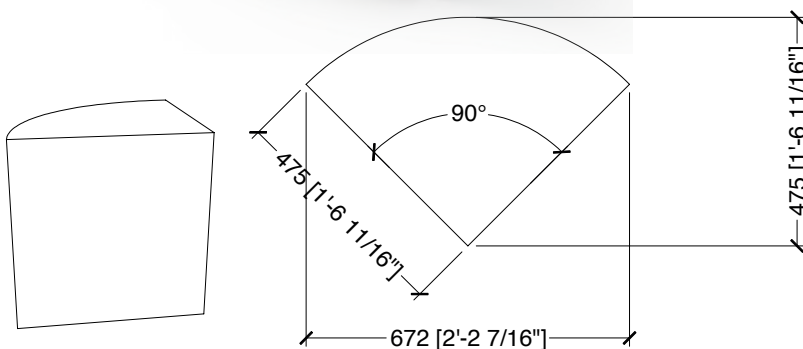

0 = product price in calculation - contact our office for pricing

Shapes - S-shape - QM Foam	QF.SHA.S.	€ 1.817	13.627
Shapes - S-shape - QM Plus	QP.SHA.S.	€ 2.026	15.193
Shapes - S-shape - QM Tex	QT.SHA.S.	€ 3.919	29.396
Shapes - S-shape - fabric CAT 0/COM	QU0.SHA.S.	€ 2.946	22.092
Shapes - S-shape - fabric CAT 1	QU1.SHA.S.	€ 3.160	23.697
Shapes - S-shape - fabric CAT 2	QU2.SHA.S.	€ 3.651	27.383
Shapes - Z-shape - QM Foam	QF.SHA.Z.	€ 1.817	13.627
Shapes - Z-shape - QM Plus	QP.SHA.Z.	€ 2.026	15.193
Shapes - Z-shape - QM Tex	QT.SHA.Z.	€ 3.919	29.396
Shapes - Z-shape - fabric CAT 0/COM	QU0.SHA.Z.	€ 2.946	22.092
Shapes - Z-shape - fabric CAT 1	QU1.SHA.Z.	€ 3.160	23.697
Shapes - Z-shape - fabric CAT 2	QU2.SHA.Z.	€ 3.651	27.383
Shapes - L-shape - QM Foam	QF.SHA.L.	€ 1.427	10.705
Shapes - L-shape - QM Plus	QP.SHA.L.	€ 1.589	11.921
Shapes - L-shape - QM Tex	QT.SHA.L.	€ 3.077	23.076
Shapes - L-shape - fabric CAT 0/COM	QU0.SHA.L.	€ 2.317	17.379
Shapes - L-shape - fabric CAT 1	QU1.SHA.L.	€ 2.488	18.662
Shapes - L-shape - fabric CAT 2	QU2.SHA.L.	€ 2.881	21.611
Shapes - T-shape - QM Foam	QF.SHA.T.	€ 1.817	13.627
Shapes - T-shape - QM Plus	QP.SHA.T.	€ 2.026	15.193
Shapes - T-shape - QM Tex	QT.SHA.T.	€ 3.919	29.396
Shapes - T-shape - fabric CAT 0/COM	QU0.SHA.T.	€ 2.946	22.092
Shapes - T-shape - fabric CAT 1	QU1.SHA.T.	€ 3.160	23.697
Shapes - T-shape - fabric CAT 2	QU2.SHA.T.	€ 3.651	27.383
Shapes - X-shape - QM Foam	QF.SHA.X.	€ 2.133	15.994
Shapes - X-shape - QM Plus	QP.SHA.X.	€ 2.387	17.905
Shapes - X-shape - QM Tex	QT.SHA.X.	€ 4.177	31.327
Shapes - X-shape - fabric CAT 0/COM	QU0.SHA.X.	€ 2.997	22.477
Shapes - X-shape - fabric CAT 1	QU1.SHA.X.	€ 3.253	24.401
Shapes - X-shape - fabric CAT 2	QU2.SHA.X.	€ 3.843	28.826
Shapes - Pentagon - QM Foam	QF.SHA.PEN.	€ 988	7.407
Shapes - Pentagon - QM Plus	QP.SHA.PEN.	€ 1.085	8.138
Shapes - Pentagon - QM Tex	QT.SHA.PEN.	€ 2.055	15.413
Shapes - Pentagon - fabric CAT 0/COM	QU0.SHA.PEN.	€ 1.596	11.974
Shapes - Pentagon - fabric CAT 1	QU1.SHA.PEN.	€ 1.690	12.678
Shapes - Pentagon - fabric CAT 2	QU2.SHA.PEN.	€ 1.907	14.300
Shapes - Hexagon - QM Foam	QF.SHA.HEX.	€ 1.308	9.806
Shapes - Hexagon - QM Plus	QP.SHA.HEX.	€ 1.437	10.779
Shapes - Hexagon - QM Tex	QT.SHA.HEX.	€ 2.481	18.611
Shapes - Hexagon - fabric CAT 0/COM	QU0.SHA.HEX.	€ 1.875	14.064

Shapes - Hexagon - fabric CAT 1	QU1.SHA.HEX.	€ 1.995	14.961
Shapes - Hexagon - fabric CAT 2	QU2.SHA.HEX.	€ 2.270	17.027
Shapes - Triangle - QM Foam	QF.SHA.TRI.	€ 449	3.367
Shapes - Triangle - QM Plus	QP.SHA.TRI.	€ 495	3.713
Shapes - Triangle - QM Tex	QT.SHA.TRI.	€ 1.400	10.502
Shapes - Triangle - fabric CAT 0/COM	QU0.SHA.TRI.	€ 1.176	8.817
Shapes - Triangle - fabric CAT 1	QU1.SHA.TRI.	€ 1.218	9.139
Shapes - Triangle - fabric CAT 2	QU2.SHA.TRI.	€ 1.317	9.875
Curves - Curve 180 - QM Foam	QF.CUR.180.	€ 1.690	12.678
Curves - Curve 180 - QM Plus	QP.CUR.180.	€ 1.860	13.948
Curves - Curve 180 - QM Tex	QT.CUR.180.	€ 5.032	37.739
Curves - Curve 180 - fabric CAT 0/COM	QU0.CUR.180.	€ 4.222	31.664
Curves - Curve 180 - fabric CAT 1	QU1.CUR.180.	€ 4.393	32.946
Curves - Curve 180 - fabric CAT 2	QU2.CUR.180.	€ 4.786	35.897
Curves - Curve 90 - QM Foam	QF.CUR.90.	€ 967	7.253
Curves - Curve 90 - QM Plus	QP.CUR.91.	€ 1.065	7.984
Curves - Curve 90 - QM Tex	QT.CUR.92.	€ 3.165	23.740
Curves - Curve 90 - fabric CAT 0/COM	QU0.CUR.93.	€ 2.696	20.217
Curves - Curve 90 - fabric CAT 1	QU1.CUR.94.	€ 2.781	20.858
Curves - Curve 90 - fabric CAT 2	QU2.CUR.95.	€ 2.978	22.334
Curves - half round - QM Foam	QF.CUR.HAR.	€ 895	6.714
Curves - half round - QM Plus	QP.CUR.HAR.	€ 993	7.445
Curves - half round - QM Tex	QT.CUR.HAR.	€ 3.147	23.600
Curves - half round - fabric CAT 0/COM	QU0.CUR.HAR.	€ 2.678	20.088
Curves - half round - fabric CAT 1	QU1.CUR.HAR.	€ 2.743	20.569
Curves - half round - fabric CAT 2	QU2.CUR.HAR.	€ 2.890	21.677
Curves - quarter round - QM Foam	QF.CUR.QUR.	€ 575	4.309
Curves - quarter round - QM Plus	QP.CUR.QUR.	€ 636	4.772
Curves - quarter round - QM Tex	QT.CUR.QUR.	€ 2.325	17.440
Curves - quarter round - fabric CAT 0/COM	QU0.CUR.QUR.	€ 2.022	15.166
Curves - quarter round - fabric CAT 1	QU1.CUR.QUR.	€ 2.086	15.647
Curves - quarter round - fabric CAT 2	QU2.CUR.QUR.	€ 2.234	16.754

SKEW  
DESIGN KAZUKO OKAMOTO  
2014



0 = product price in calculation - contact our office for pricing

# SKEW

## DESIGN KAZUKO OKAMOTO

### 2014



SKEW is a thrilling modular sofa designed by Kazuko Okamoto, a Japanese designer with her roots in Japan. Skew is a design idea that gives you the possibility to combine, turn, create unexpected twists to your project.

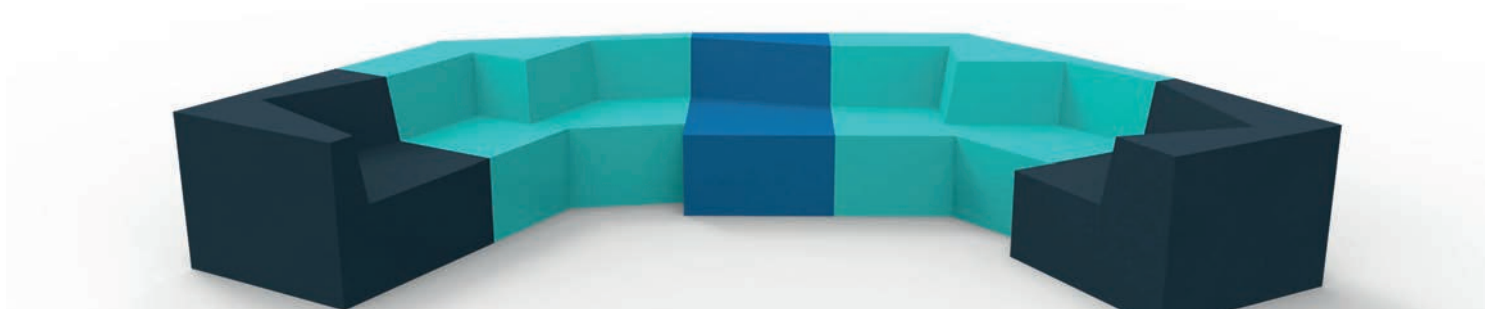

#### SKEW CHAIR CORNER

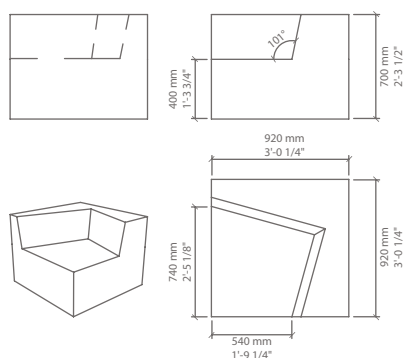

- Skew - chair corner - QM Foam skin
- Skew - chair corner - QM Plus foamskin double

#### SKEW CHAIR STRAIGHT

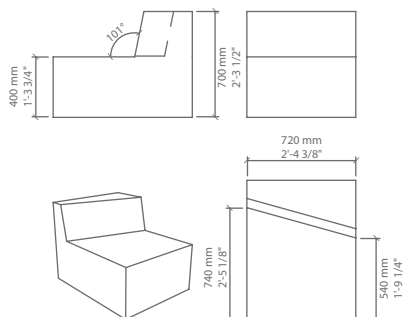

- Skew - chair straight - QM Foam skin
- Skew - chair straight - foamskin double

#### SKEW SOFA

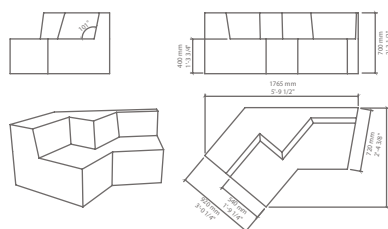

- Skew - sofa - QM Foam skin
- Skew - sofa - QM Plus foamskin double

0 = product price in calculation - contact our office for pricing

Skew - chair corner - QM Foam	QF.SKE.CHA.COR	€ 2.690	20.172
Skew - chair corner - QM Plus	QP.SKE.CHA.COR	€ 2.908	21.811
Skew - sofa - QM Foam	QT.SKE.SOF.	€ 3.423	25.673
Skew - sofa - QM Plus	QU0.SKE.SOF.	€ 3.390	25.423
Skew - chair straight - QM Foam	QU1.SKE.CHA.STR	€ 1.710	12.828
Skew - chair straight - QM Plus	QU2.SKE.CHA.STR	€ 1.890	14.175



# SLING

DESIGN Patrick Rampelotto

2021



0 = product price in calculation - contact our office for pricing

# SLING

DESIGN Patrick Rampelotto  
2021



> SLING

> Design by Patrick Rampelotto, 2021

> The SLING collection offers a bistro table in powder coated steel for use outdoor. A solide metal frame with some clever solutions to range chairs and tables when not in use. Perfectly made for your bistro terrace.  
Optional seat and back cushions can be applied.

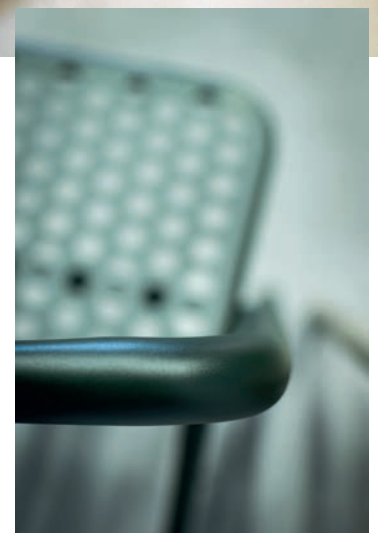
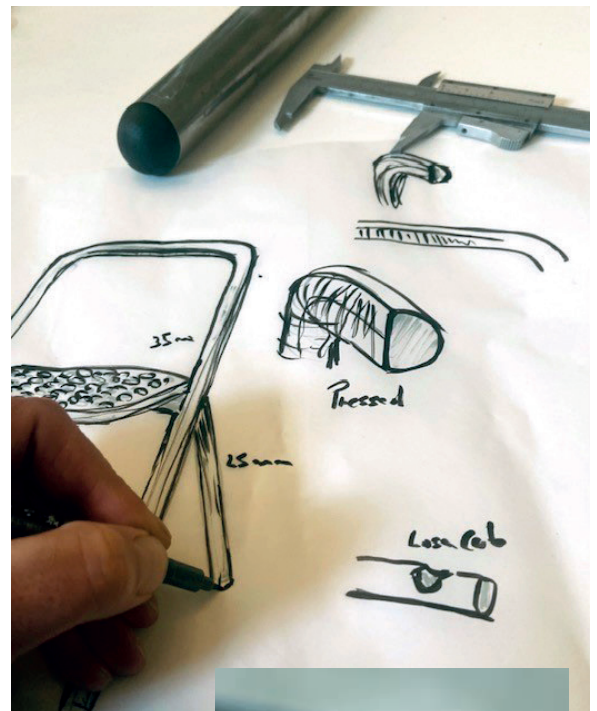

0 = product price in calculation - contact our office for pricing

# SLING

DESIGN Patrick Rampelotto

2021



## SLING CHAIR



0 = product price in calculation - contact our office for pricing

# SLING

DESIGN Patrick Rampelotto

2021



## SLING TABLE



0 = product price in calculation - contact our office for pricing

# SLING

DESIGN Patrick Rampelotto

2021



## **SLING stackable bistro chair and folding table**

the SLING bistro chair has been designed so it can easily be stacked

the SLING bistro table is designed with a folding top so it can be ranged in a limited space



0 = product price in calculation - contact our office for pricing

# SLING

DESIGN Patrick Rampelotto

2021



0 = product price in calculation - contact our office for pricing

Sling chair	Sl.Chair	€ 290	2.178
Sling Table	SL.table	€ 414	3.104

# SQUARES

DESIGN SDC\_lab

2016



SQUARES IS THE NEW SIZABLE SQUARE BLOCK.

Sizable in width, depth and height.

We offer some standard sizes but these blocks can easily be customized in all directions.

We offer some standard sizes for your convenience; keeping a standard seating height from 47,5cm the standard steps are 47,5 - 95 - 142,5

Square 01 starts from w47,5 x D 47,5 x h 47,5

Square 02 is then w95 x d95 x h 47,5

Square 03 is w142,5 x d142,5 x h47,5cm

Of course you can add your specific size to the blocks, keeping the base shape rectangular and seating height at 47,5cm

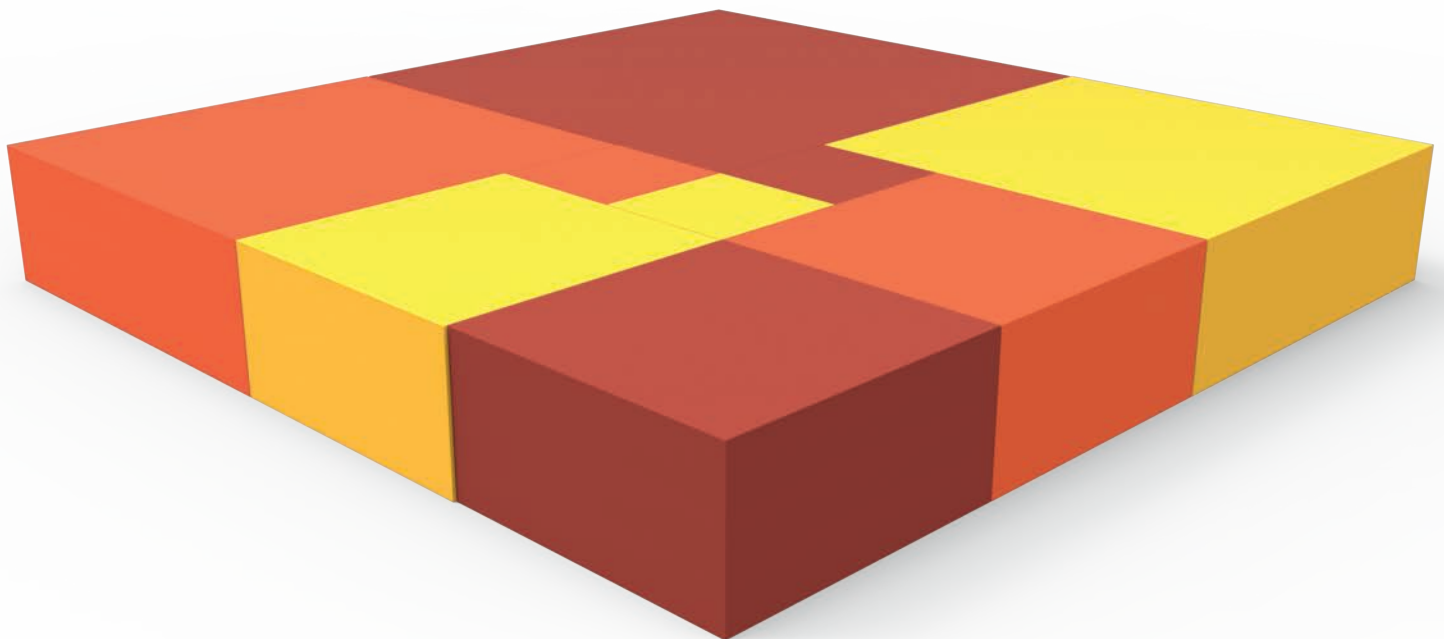
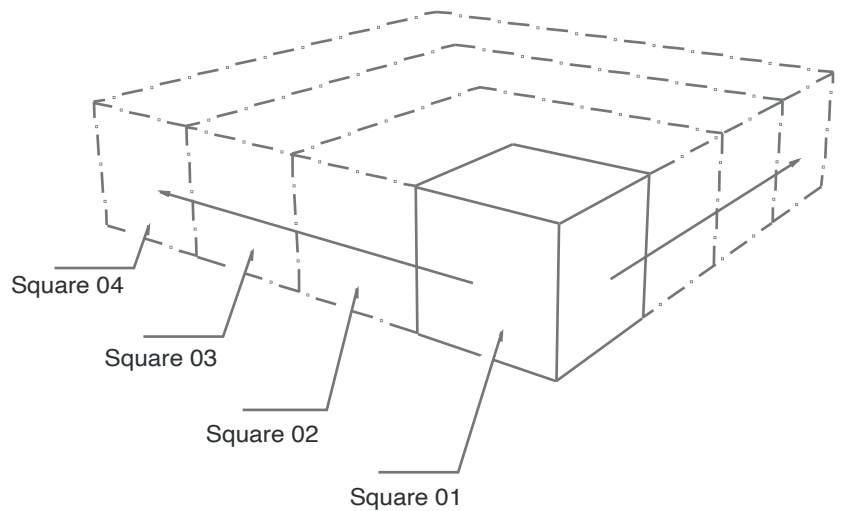

0 = product price in calculation - contact our office for pricing



## SQUARES 01

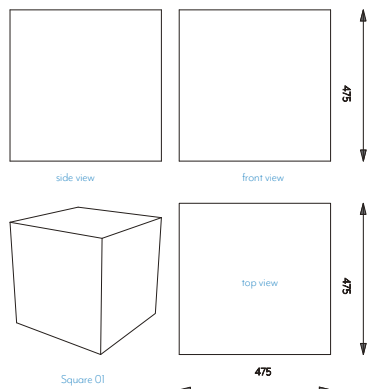

- ..... Squares - Square 01 - QM Foam skin
- ..... Squares - Square 01 - QM Plus foamskin double
- ..... Squares - Square 01 - QM Tex foamskin Tex
- ..... Squares - Square 01 - fabric CAT 1
- ..... Squares - Square 01 - fabric CAT 2
- ..... Squares - Square 01 - fabric CAT 0/COM

## SQUARES 02

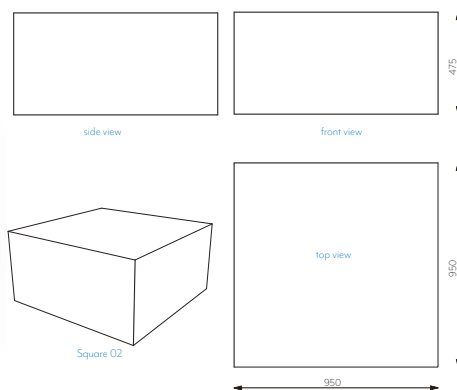

- ..... Squares - Square 02 - QM Foam skin
- ..... Squares - Square 02 - QM Plus foamskin double
- ..... Squares - Square 02 - QM Tex foamskin Tex
- ..... Squares - Square 02 - fabric CAT 1
- ..... Squares - Square 02 - fabric CAT 2
- ..... Squares - Square 02 - fabric CAT 0/COM

## SQUARES 03

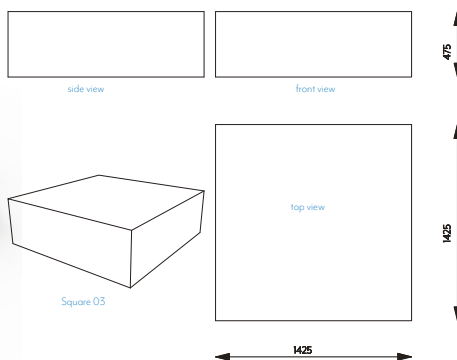
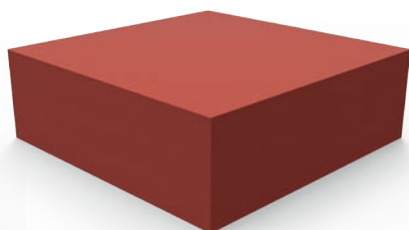

- ..... Squares - Square 03 - QM Foam skin
- ..... Squares - Square 03 - QM Plus foamskin double
- ..... Squares - Square 03 - QM Tex foamskin Tex
- ..... Squares - Square 03 - fabric CAT 1
- ..... Squares - Square 03 - fabric CAT 2
- ..... Squares - Square 03 - fabric CAT 0/COM

## SQUARES 04

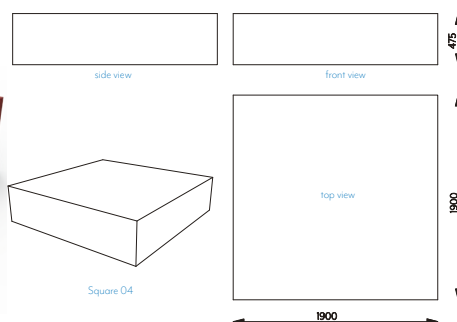
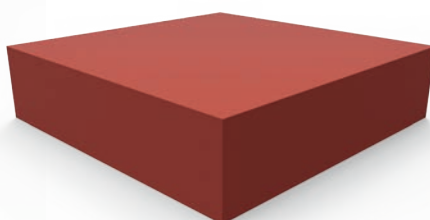

- ..... Squares - Square 04 - QM Foam skin
- ..... Squares - Square 04 - QM Plus foamskin double
- ..... Squares - Square 04 - QM Tex foamskin Tex
- ..... Squares - Square 04 - fabric CAT 1
- ..... Squares - Square 04 - fabric CAT 2
- ..... Squares - Square 04 - fabric CAT 0/COM

0 = product price in calculation - contact our office for pricing

Squares - Square 01 - QM Foam	QF.SQU..01	€ 523	3.924
Squares - Square 01 - QM Plus	QP.SQU..01	€ 595	4.463
Squares - Square 01 - QM Tex	QT.SQU..01	€ 962	7.213
Squares - Square 01 - fabric CAT 0/COM	QU0.SQU..01	€ 628	4.714
Squares - Square 01 - fabric CAT 1	QU1.SQU..01	€ 714	5.354
Squares - Square 01 - fabric CAT 2	QU2.SQU..01	€ 911	6.830
Squares - Square 02 - QM Foam	QF.SQU..02	€ 1.289	9.667
Squares - Square 02 - QM Plus	QP.SQU..02	€ 1.425	10.687
Squares - Square 02 - QM Tex	QT.SQU..02	€ 2.384	17.881
Squares - Square 02 - fabric CAT 0/COM	QU0.SQU..02	€ 1.753	13.146
Squares - Square 02 - fabric CAT 1	QU1.SQU..02	€ 1.881	14.108
Squares - Square 02 - fabric CAT 2	QU2.SQU..02	€ 2.176	16.320
Squares - Square 03 - QM Foam	QF.SQU..03	€ 3.006	22.548
Squares - Square 03 - QM Plus	QP.SQU..03	€ 3.355	25.165
Squares - Square 03 - QM Tex	QT.SQU..03	€ 4.036	30.272
Squares - Square 03 - fabric CAT 0/COM	QU0.SQU..03	€ 2.450	18.373
Squares - Square 03 - fabric CAT 1	QU1.SQU..03	€ 2.749	20.618
Squares - Square 03 - fabric CAT 2	QU2.SQU..03	€ 3.437	25.780
Squares - Square 04 - QM Foam	QF.SQU..04	€ 5.089	38.169
Squares - Square 04 - QM Plus	QP.SQU..04	€ 5.654	42.402
Squares - Square 04 - QM Tex	QT.SQU..04	€ 5.991	44.932
Squares - Square 04 - fabric CAT 0/COM	QU0.SQU..04	€ 3.427	25.700
Squares - Square 04 - fabric CAT 1	QU1.SQU..04	€ 3.940	29.548
Squares - Square 04 - fabric CAT 2	QU2.SQU..04	€ 5.120	38.398

# STRAIGHTS

DESIGN SDC\_lab

2016



STRAIGHTS IS THE NEW SIZABLE RECTANGULAR BLOCK.

Sizable in width, depth and height.

We offer some standard sizes but these blocks can easily be customized in all directions.

We offer some standard sizes for your convenience; keeping a standard seating height from 47,5cm and depth 47,5cm the standard steps are 95 - 142,5 - 190cm

Straight 01 starts from w95 x D 47,5 x h 47,5

Straight 02 is then w142,5 x d47,5 x h 47,5

Straight 03 is w190 x d47,5 x h47,5cm

Of course you can add your specific size to the blocks, keeping the base shape rectangular and seating height at 47,5cm

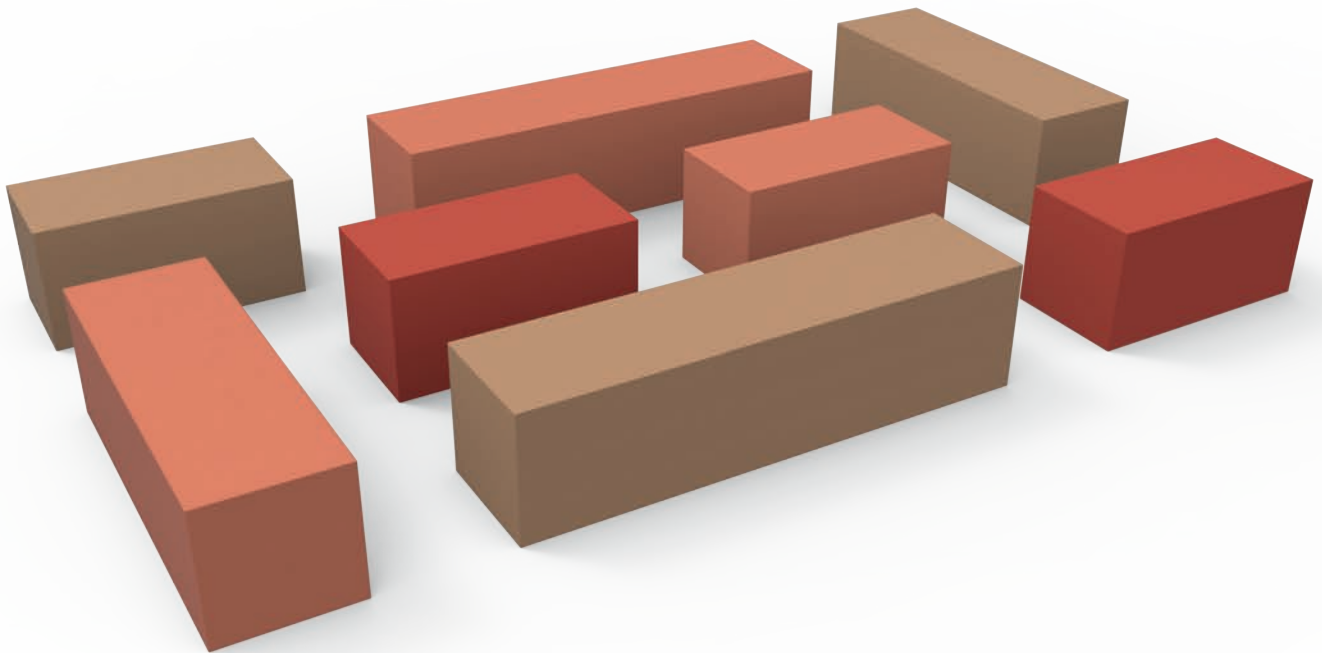
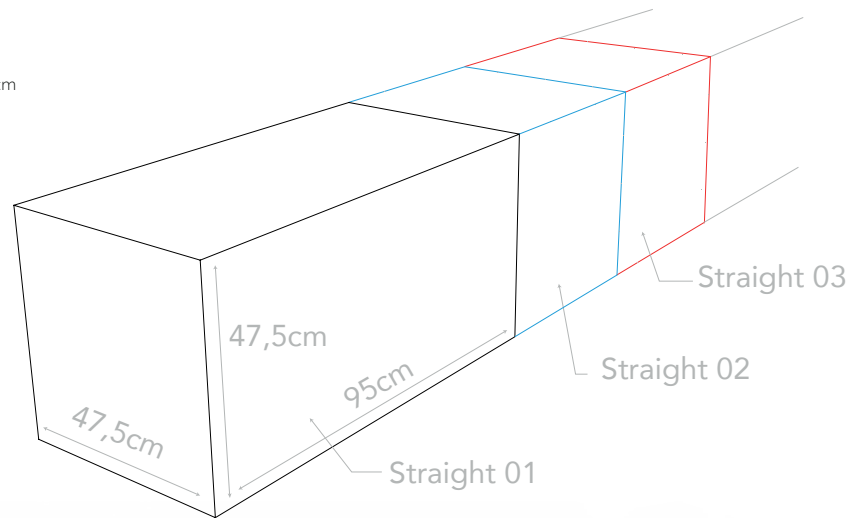

0 = product price in calculation - contact our office for pricing

# STRAIGHTS

DESIGN SDC\_lab

2016



## STRAIGHTS 01

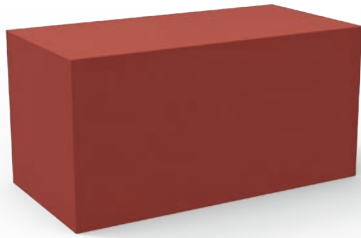

side view

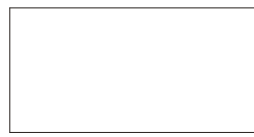

front view

475

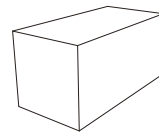

Straight 01



top view

475

950

- ..... Straight - Straight 01 - QM Foam skin
- ..... Straight - Straight 01 - QM Plus foamskin double
- ..... Straight - Straight 01 - QM Tex foamskin Tex
- ..... Straight - Straight 01 - fabric CAT 1
- ..... Straight - Straight 01 - fabric CAT 2
- ..... Straight - Straight 01 - fabric CAT 0/COM

## STRAIGHTS 02

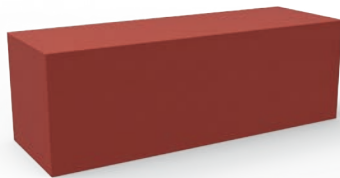

side view

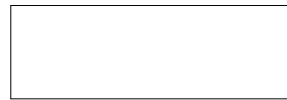

front view

475

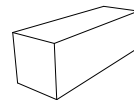

Straight 02



top view

475

1425

- ..... Straight - Straight 02 - QM Foam skin
- ..... Straight - Straight 02 - QM Plus foamskin double
- ..... Straight - Straight 02 - QM Tex foamskin Tex
- ..... Straight - Straight 02 - fabric CAT 1
- ..... Straight - Straight 02 - fabric CAT 2
- ..... Straight - Straight 02 - fabric CAT 0/COM

## STRAIGHTS 03

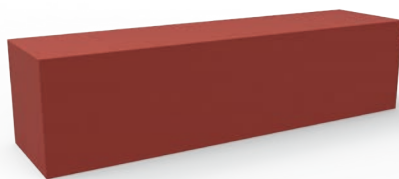

side view



front view

475

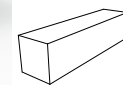

Straight 03



top view

475

1500

- ..... Straight - Straight 03 - QM Foam skin
- ..... Straight - Straight 03 - QM Plus foamskin double
- ..... Straight - Straight 03 - QM Tex foamskin Tex
- ..... Straight - Straight 03 - fabric CAT 1
- ..... Straight - Straight 03 - fabric CAT 2
- ..... Straight - Straight 03 - fabric CAT 0/COM

0 = product price in calculation - contact our office for pricing

Straight - Straight 01 - QM Foam	QF.STR..01	€ 931	6.984
Straight - Straight 01 - QM Plus	QP.STR..01	€ 1.049	7.868
Straight - Straight 01 - QM Tex	QT.STR..01	€ 1.618	12.135
Straight - Straight 01 - fabric CAT 0/COM	QU0.STR..01	€ 1.075	8.064
Straight - Straight 01 - fabric CAT 1	QU1.STR..01	€ 1.161	8.705
Straight - Straight 01 - fabric CAT 2	QU2.STR..01	€ 1.357	10.180
Straight - Straight 02 - QM Foam	QF.STR..02	€ 1.288	9.658
Straight - Straight 02 - QM Plus	QP.STR..02	€ 1.452	10.890
Straight - Straight 02 - QM Tex	QT.STR..02	€ 2.342	17.564
Straight - Straight 02 - fabric CAT 0/COM	QU0.STR..02	€ 1.588	11.912
Straight - Straight 02 - fabric CAT 1	QU1.STR..02	€ 1.717	12.874
Straight - Straight 02 - fabric CAT 2	QU2.STR..02	€ 2.012	15.086
Straight - Straight 03 - QM Foam	QF.STR..03	€ 1.665	12.485
Straight - Straight 03 - QM Plus	QP.STR..03	€ 1.875	14.064
Straight - Straight 03 - QM Tex	QT.STR..03	€ 2.856	21.419
Straight - Straight 03 - fabric CAT 0/COM	QU0.STR..03	€ 1.892	14.190
Straight - Straight 03 - fabric CAT 1	QU1.STR..03	€ 2.063	15.471
Straight - Straight 03 - fabric CAT 2	QU2.STR..03	€ 2.456	18.422

# STAIR SEAT

DESIGN SDC lab  
2016

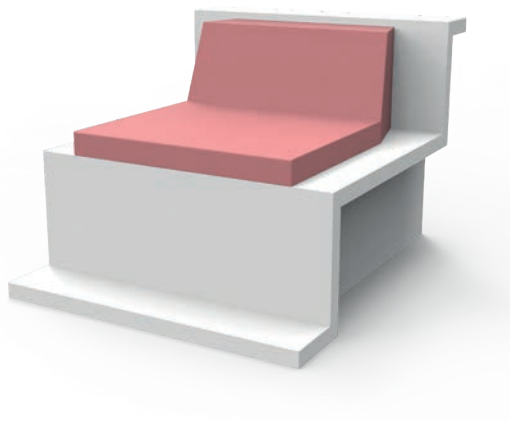
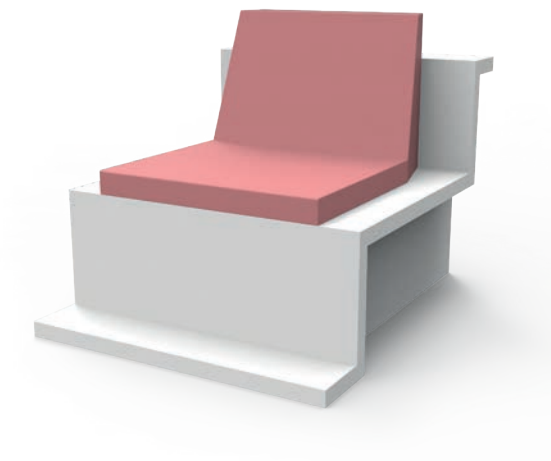

## STAIR SEAT L cushion

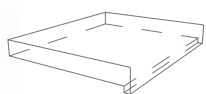

Stair seat L

- .....
- Stair Seat - L cushion no back - QM Foam skin
- .....
- Stair Seat - L cushion no back - QM Plus foamskin double
- .....
- Stair Seat - L cushion no back - QM Tex foamskin Tex
- .....
- Stair Seat - L cushion no back - fabric CAT 1
- .....
- Stair Seat - L cushion no back - fabric CAT 2
- .....
- Stair Seat - L cushion no back - fabric CAT 0/COM
- .....

## STAIR SEAT L cushion with high back

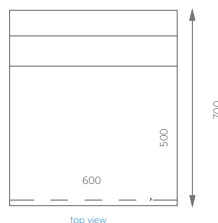
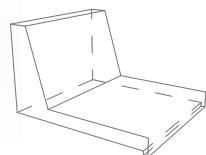
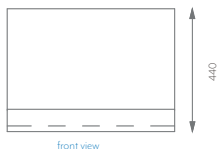
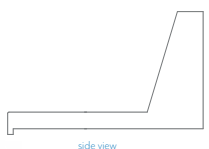

Stair seat L with backrest

- .....
- Stair Seat - L cushion with back - QM Foam skin
- .....
- Stair Seat - L cushion with back - QM Plus foamskin double
- .....
- Stair Seat - L cushion with back - QM Tex foamskin Tex
- .....
- Stair Seat - L cushion with back - fabric CAT 1
- .....
- Stair Seat - L cushion with back - fabric CAT 2
- .....
- Stair Seat - L cushion with back - fabric CAT 0/COM
- .....

0 = product price in calculation - contact our office for pricing

# STAIR SEAT

DESIGN SDC lab  
2016



## STAIR SEAT HIGH BACK

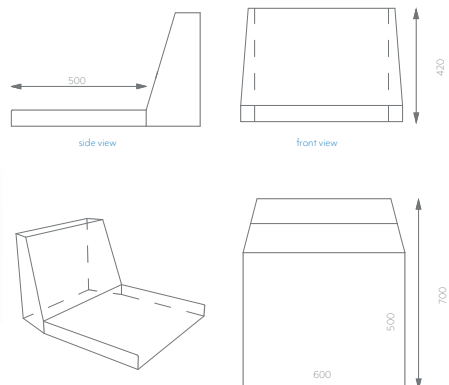

- .....
- ..... Stair Seat - high back - QM Foam skin
- ..... Stair Seat - high back - QM Plus foamskin double
- ..... Stair Seat - high back - QM Tex foamskin Tex
- ..... Stair Seat - high back - fabric CAT 1
- ..... Stair Seat - high back - fabric CAT 2
- ..... Stair Seat - high back - fabric CAT 0/COM
- .....



## STAIR SEAT LOW BACK

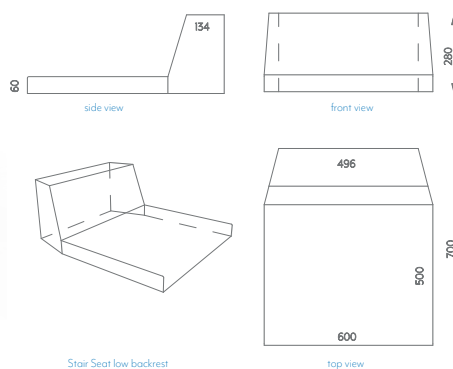

- .....
- ..... Stair Seat - low back - QM Foam skin
- ..... Stair Seat - low back - QM Plus foamskin double
- ..... Stair Seat - low back - QM Tex foamskin Tex
- ..... Stair Seat - low back - fabric CAT 1
- ..... Stair Seat - low back - fabric CAT 2
- ..... Stair Seat - low back - fabric CAT 0/COM
- .....

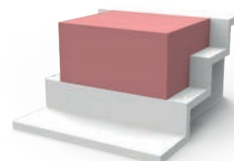

## STAIR SEAT PLATFORM

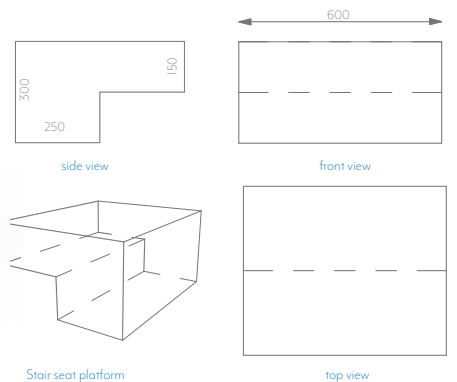

Stair seat platform

top view

0 = product price in calculation - contact our office for pricing

Stair Seat - high back - QM Foam	QF.STA.SEA.HBA	€ 680	5.097
Stair Seat - high back - QM Plus	QP.STA.SEA.HBA	€ 752	5.639
Stair Seat - high back - QM Tex	QT.STA.SEA.HBA	€ 1.061	7.955
Stair Seat - high back - fabric CAT 0/COM	QU0.STA.SEA.HBA	€ 724	5.427
Stair Seat - high back - fabric CAT 1	QU1.STA.SEA.HBA	€ 788	5.908
Stair Seat - high back - fabric CAT 2	QU2.STA.SEA.HBA	€ 935	7.015
Stair Seat - low back - QM Foam	QF.STA.SEA.LBA	€ 596	4.472
Stair Seat - low back - QM Plus	QP.STA.SEA.LBA	€ 660	4.953
Stair Seat - low back - QM Tex	QT.STA.SEA.LBA	€ 1.007	7.552
Stair Seat - low back - fabric CAT 0/COM	QU0.STA.SEA.LBA	€ 695	5.211
Stair Seat - low back - fabric CAT 1	QU1.STA.SEA.LBA	€ 759	5.692
Stair Seat - low back - fabric CAT 2	QU2.STA.SEA.LBA	€ 906	6.797
Stair Seat - L cushion no back - QM Foam	QF.STA.LCUS.NB	€ 314	2.354
Stair Seat - L cushion no back - QM Plus	QP.STA.LCUS.NB	€ 353	2.648
Stair Seat - L cushion no back - QM Tex	QT.STA.LCUS.NB	€ 575	4.316
Stair Seat - L cushion no back - fabric CAT 0/COM	QU0.STA.LCUS.NB	€ 380	2.853
Stair Seat - L cushion no back - fabric CAT 1	QU1.STA.LCUS.NB	€ 423	3.174
Stair Seat - L cushion no back - fabric CAT 2	QU2.STA.LCUS.NB	€ 522	3.911
Stair Seat - L cushion with back - QM Foam	QF.STA.LCUS.B	€ 651	4.884
Stair Seat - L cushion with back - QM Plus	QP.STA.LCUS.B	€ 729	5.465
Stair Seat - L cushion with back - QM Tex	QT.STA.LCUS.B	€ 1.074	8.057
Stair Seat - L cushion with back - fabric CAT 0/COM	QU0.STA.LCUS.B	€ 695	5.211
Stair Seat - L cushion with back - fabric CAT 1	QU1.STA.LCUS.B	€ 759	5.692
Stair Seat - L cushion with back - fabric CAT 2	QU2.STA.LCUS.B	€ 906	6.797



UDA

DESIGN SDC\_lab (intern Paul Gallaud)

2017



0 = product price in calculation - contact our office for pricing

UDA is a the new 'rocking' pouf.

Paul Gallaud was working with us as an intern; All of the sudden he came with the idea to make a new rocking pouf.

Available in 3 sizes and different finishings.

Give it to kids or use it in informal spaces to sit, to play or just as a seat around a meeting room table.



UDA small

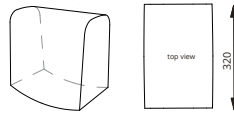
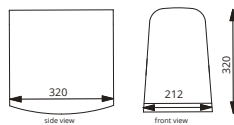

- Uda - small - QM Foam skin
- Uda - small - QM Plus foamskin double
- Uda - small - QM Tex foamskin Tex
- Uda - small - fabric CAT 1
- Uda - small - fabric CAT 2
- Uda - small - fabric CAT 0/COM

UDA medium

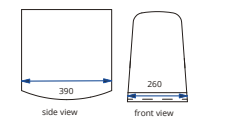

- Uda - middle - QM Foam skin
- Uda - middle - QM Plus foamskin double
- Uda - middle - QM Tex foamskin Tex
- Uda - middle - fabric CAT 1
- Uda - middle - fabric CAT 2
- Uda - middle - fabric CAT 0/COM

UDA large

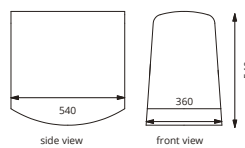

- Uda - large - QM Foam skin
- Uda - large - QM Plus foamskin double
- Uda - large - QM Tex foamskin Tex
- Uda - large - fabric CAT 1
- Uda - large - fabric CAT 2
- Uda - large - fabric CAT 0/COM

0 = product price in calculation - contact our office for pricing



PLATFORM  
FOR  
FURNITURE

# MAKE YOUR OWN FURNITURE SPACE DRIVEN SOLUTIONS

SDC's in house design team can help you with 'customizing' your ideas.

The professional approach guides you towards the ideal solution, taking into account many aspects such as finishing, density, ergonomics, power integrations,...

Contact us at [info@sdclab.be](mailto:info@sdclab.be)

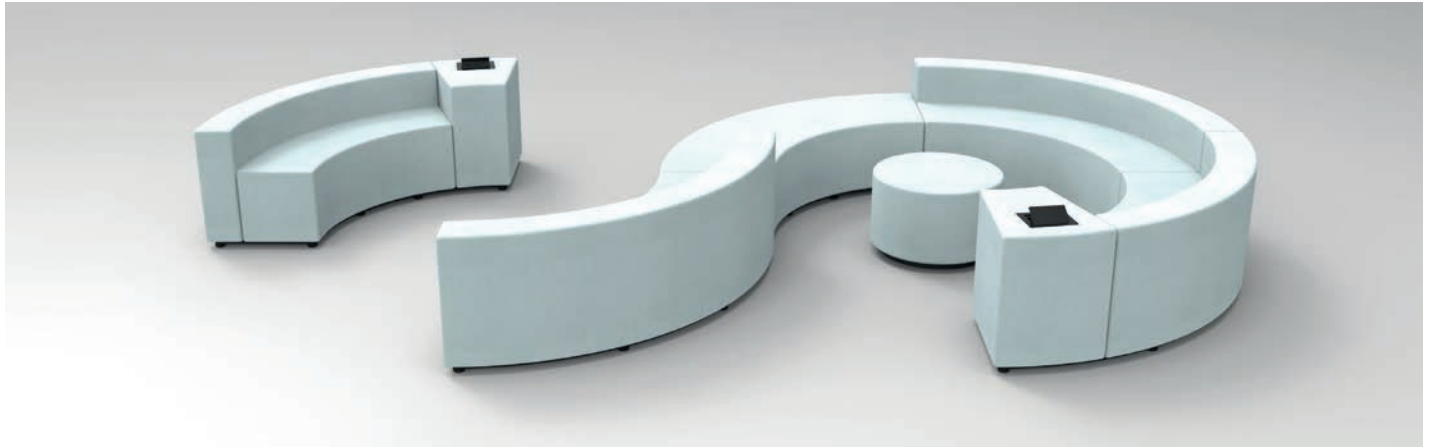

Uda - small - QM Foam	QF.UDA.SMA	€ 300	2.252
Uda - small - QM Plus	QP.UDA.SMA	€ 307	2.301
Uda - small - QM Tex	QT.UDA.SMA	€ 400	2.998
Uda - small - fabric CAT 0/COM	QU0.UDA.SMA	€ 293	2.200
Uda - small - fabric CAT 1	QU1.UDA.SMA	€ 321	2.407
Uda - small - fabric CAT 2	QU2.UDA.SMA	€ 385	2.888
Uda - middle - QM Foam	QF.UDA.MID	€ 377	2.830
Uda - middle - QM Plus	QP.UDA.MID	€ 387	2.900
Uda - middle - QM Tex	QT.UDA.MID	€ 528	3.960
Uda - middle - fabric CAT 0/COM	QU0.UDA.MID	€ 374	2.804
Uda - middle - fabric CAT 1	QU1.UDA.MID	€ 410	3.078
Uda - middle - fabric CAT 2	QU2.UDA.MID	€ 703	5.273
Uda - large - QM Foam	QF.UDA.LAR	€ 513	3.850
Uda - large - QM Plus	QP.UDA.LAR	€ 528	3.957
Uda - large - QM Tex	QT.UDA.LAR	€ 720	5.398
Uda - large - fabric CAT 0/COM	QU0.UDA.LAR	€ 492	3.692
Uda - large - fabric CAT 1	QU1.UDA.LAR	€ 537	4.029
Uda - large - fabric CAT 2	QU2.UDA.LAR	€ 890	6.677

IN ADDITION TO PRODUCING FURNITURE AT OUR IN-HOUSE FACTORY, WE WORK WITH ARCHITECTS AND DESIGNERS TO REALISE THEIR IDEAS/ DESIGNS.

OUR PRODUCTION TECHNIQUES ALLOW US TO MAKE A LOT OF SHAPES, FROM RECTANGULAR TO ORGANIC.

BUT STILL THERE ARE SOME GUIDELINES.

## GLUELINES

Straight units shorter than 210cm can be made out of 1 piece. We can also produce units which are longer but then, a glue line might be visible.

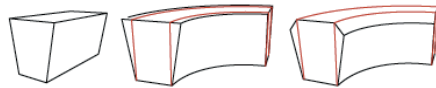

## INTEGRATIONS

in this area of technical wildlife, we need to create furniture with clever integrations. We can integrate tablets, screens, powerunits, etc. into our furniture products.

## UPGRADES

For hygienic en maintenance purposes in public areas, we often propose to add a plinth. A plinth can be made out of foam or wood, depending on the clients demands. A wooden plinth can be provided of a black laminated or a stainless steel finish.

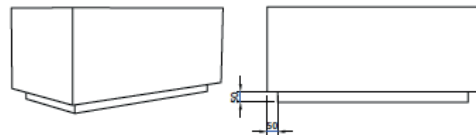

## DIMENSIONS

For cushions or wall panels, a minimum foam thickness of 5cm is required.

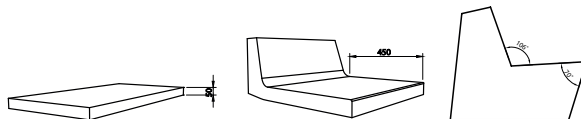

## FIXATION

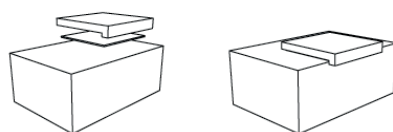

For cushions which are meant to be mounted on a wooden base or a wall, we always use a wooden plate underneath the foam for fixation with screws. That plate is smaller then the foam and will be coated in the same color as the foam.



PLATFORM  
FOR  
FURNITURE

# UPGRADES

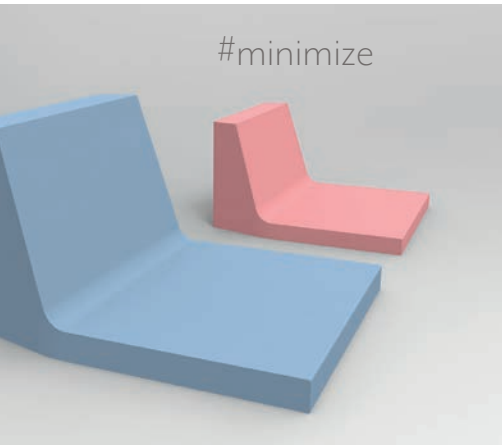
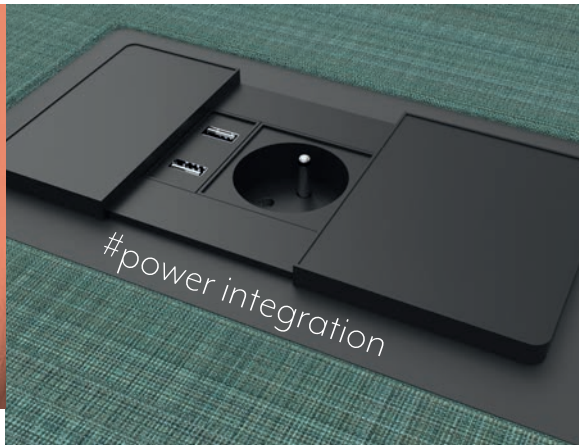

#minimize  
#screenprinting  
#tablet integration  
#power integration

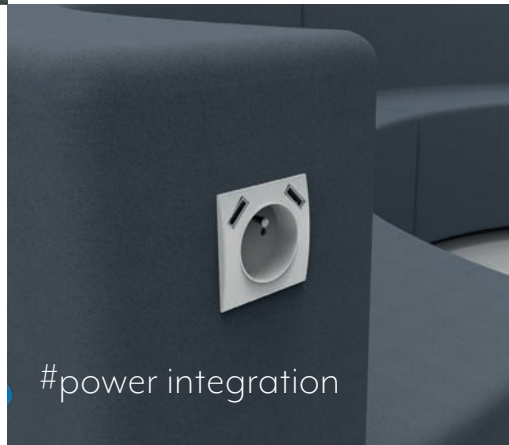

#outdoor





PLATFORM  
FOR  
FURNITURE

# #SCREENPRINTING

## ADD GRAPHICS

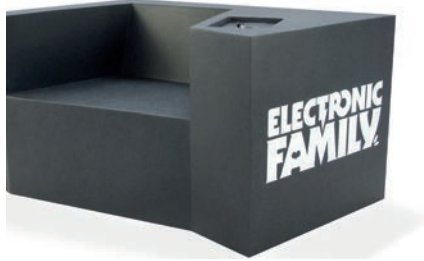

As customization is part of our DNA, we also found a solution to add company logos or graphical effects to our furniture.

Our customized items can be pimped up with your logo.

A technique with screenprinting offers new solutions for branding requirements

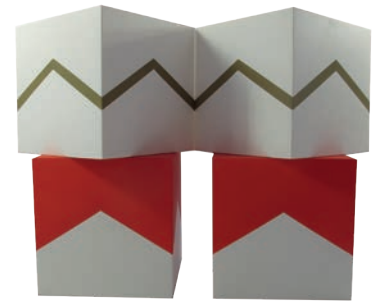



PLATFORM  
FOR  
FURNITURE

## #POWER INTEGRATION

### DEVICE EMBEDDING YOU ASK, WE CREATE

To answer to the need of connectivity in our social environments, we have developed custom made bases and connections for our furniture that allow you to securely plug in electronic devices like tablets, phones, earplugs among others to allow the user of this furniture to expand its experience to another level. The base is custom made and can be adapted to your device or furniture of choice.

Technical details:

Option 1:

Built-in plate, made to custom size (up to 50cm x 50cm). Cables can pass through the furniture.

Option 2:

Customized integration of anti-theft systems for e-readers and tablets of various brands. Completely with power integration and cables.

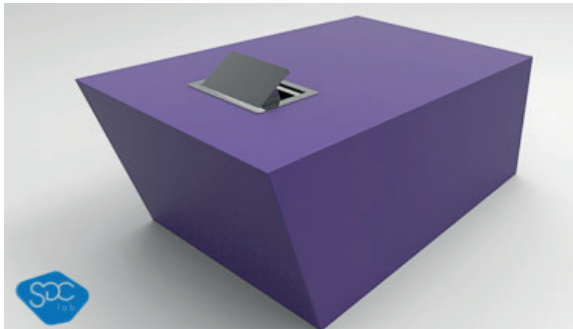

Contact us with your ideas!



## #TABLET INTEGRATION







PLATFORM  
FOR  
FURNITURE

## #MINIMIZE

SCALE  
SHRINK  
MINIMIZE

You can call it what you want, but the result is the same!

We can scale most of our furniture items down to the size that kids can also play with our furniture!

We're not only giving you the opportunity to play with colors, but you can also make the furniture onto kids' sizes

Contact us with your ideas!





PLATFORM  
FOR  
FURNITURE

#FEET #SOCCLE  
#CONNECTOR

### Connecting the pieces

For some occasions special feet are required in a project. Or even more, we can offer you a customized soccle which gives an extra protection against abuse or damage.

These feet can also have a connecting purpose. With a simple system, we created an easy way to connect the different pieces.

Contact us!

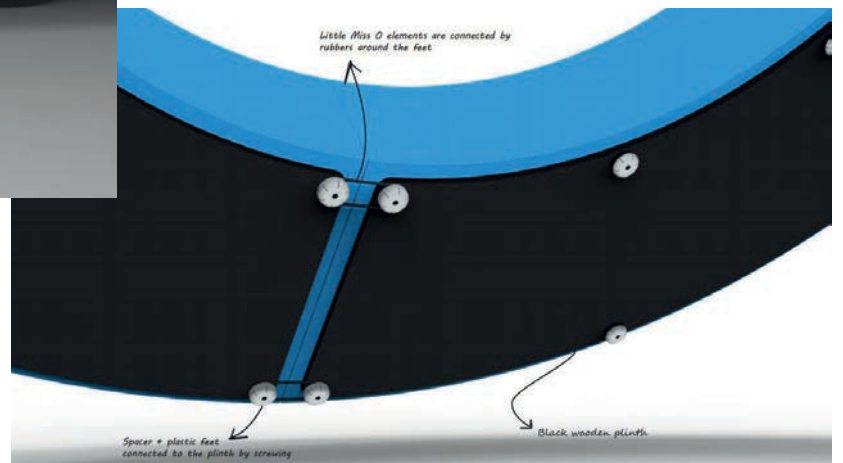
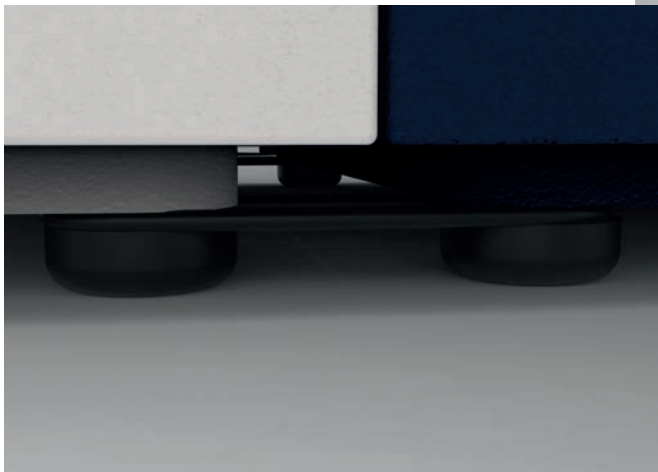



## QM Coating products

Our QM coating products are water repellent. So this means that they don't care about a little bit of water.

But they can't be use for permanent outdoor use in all climatical conditions.

Contact us for appropriate advice!



## Following the sun

We know that you sometimes would like to take your favorite pieces of furniture outside.

But not all items are standard suitable for outdoor use. But we can easily modify them to be suitable for outdoor use.

Contact us!

## Permanent outdoor use!

Our foamcoating is not recommended for permanent outdoor use.

We can in most cases change the type of foam and fabric to be suitable for permanent outdoor use!

Using a special foam for outdoor use and some special fabrics combined with a special finishing technique gives you the best result.

Contact us!

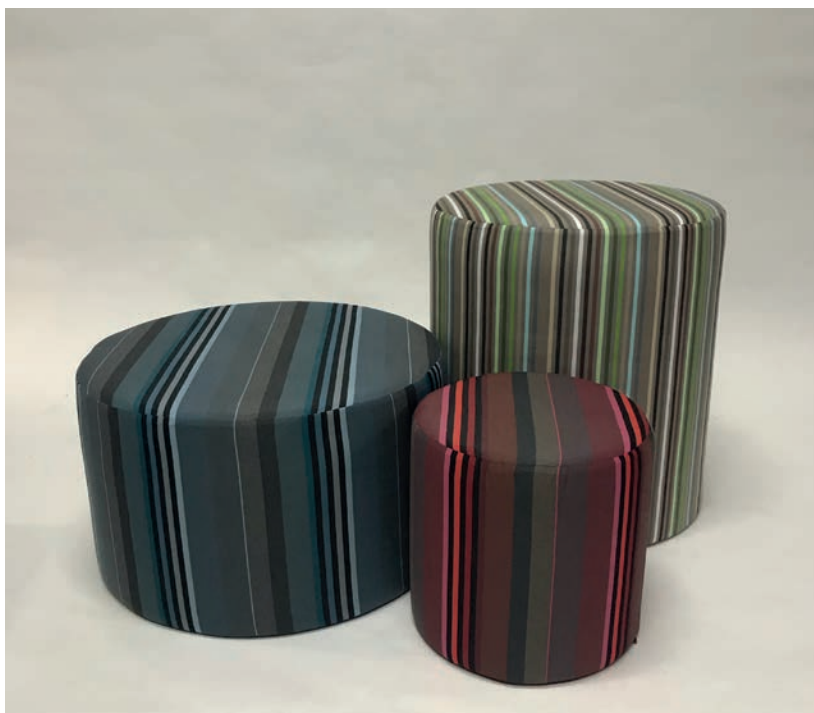

Second skin full leather QM COM	QW.SEC.SKI N	€ 2.268	17.007
Cover - Round 03 - Cover	COV.RO.03	€ 107	805
Cover - infinity straight L - Cover	COV.INF.STL	€ 217	1.627
Cover - infinity straight XL - Cover	COV.INF.SXL	€ 284	2.133
Repair kit - repair kit - cleaning	REPAIR	€ 110	825
cleaning - Aqua clean - cleaning	CLE.FOAM	€ 49	365
cleaning - magic sponge - cleaning spray	CLE.SP	€ 33	250
cleaning - Complete cleaning kit - cleaning	CLE.KIT	€ 90	673
Colors - Color QM range - color	COL.COL	€ 77	577
order cost for order with value <900 euro (administration and transport contribution)	TRA	€ 128	957
QM Custom color charge	COL.CUS	€ 99	743
Repairkit	REPAIRKIT		0
Airbench small boomerang - no cushions	QW.AIR.SBO	€ 2.370	17.776



## Article 1 Scope.

§ 1. These general terms and conditions apply to every offer made by, every agreement concluded with and every delivery made by SDC bvba, with company number 0545.930.648 and with registered office at 8560 WEVELGEM, 13 (hereinafter: "SDC") and are an integral part of the contractual relationship between SDC and the customer. They supplement the special conditions agreed by the parties. Insofar as the special conditions that the parties agreed to deviate from these general terms and conditions, the special conditions that the parties agreed to take precedence over these general terms and conditions.

§ 2. By the mere fact of accepting an offer made by, entering into an agreement with and / or accepting a delivery made by SDC, the customer acknowledges to have read and accepted these general terms and conditions.

§ 3. The customer acknowledges that the application of his own general terms and conditions is expressly excluded.

## Article 2 Conclusion of the agreement.

§ 1. Unless SDC has explicitly stated otherwise, all its offers are non-binding and non-binding. SDC is only bound when it has confirmed the customer's order. SDC's quotations are in any case subject to sufficient stock.

§ 2. Only persons who have external representation authority under the SDC articles of association can bind SDC. The employees of SDC and the intermediaries to whom it would appeal cannot, as a rule, bind SDC unless they provide a written proxy.

§ 3. The customer can no longer cancel his order that SDC has accepted unless SDC agrees to this in writing. In case SDC agrees to such cancellation, the customer will in any case, unless otherwise agreed in writing, owe a cancellation fee of 30% of the amount of the canceled order.

## Article 3 Prices.

§ 1. Unless SDC has indicated otherwise in writing, the prices quoted by SDC are expressed in euros and exclude VAT, packaging costs and shipping costs.

§ 2. For orders with a value less than EUR 900 excl. VAT, an extra administration fee will be charged on top of the agreed price.

§ 3. SDC has the right to determine which packaging and which shipping method are most suitable. Packaging will not be taken back.

§ 4. Prices for coated products are so conceived that everything is done in one standard color.

As soon as you want an extra color within an order, you must add a color change. A small surcharge is charged for this, regardless of the numbers per color. The prices of this color change are stated on the offer.

In the case of custom colors, a supplement will also be requested.

§ 5. Discounts and reductions

Unless expressly stated in the order confirmation from SDC, the buyer is not entitled to any direct or indirect discount, reduction, commission or reduction of any kind. Any discount promised by SDC for the prepayment of an invoice will only be granted if the full amount stated on the invoice has been received by SDC on or before the invoice's due date.

## Article 4 Delivery.

§ 1. SDC always has the right to split the customer's order into partial deliveries.

§ 2. The delivery terms for SDC are always approximate (indicative) unless it has been expressly agreed in writing that the delivery term can be strictly observed by means of the statement "mandatory delivery term" or a similar statement that unambiguously indicates the punctuality of the delivery term. SDC will use its best endeavors to comply with the approximate delivery time specified by it. The customer acknowledges that he is aware that deviations from the delivery period can always occur, among other due to delays at producers, suppliers and execution agents on which SDC depends and / or its possibilities of preparing and sending the goods. In the event of a delay in implementation, the customer will in no case be able to demand the termination of the agreement and the customer will in no way be able to claim any compensation of any kind from SDC. If SDC, in case of a mandatory delivery period, has not executed on time, the customer must first notify SDC by registered letter and give a last grace period of at least 15 days before he can invoke any sanction against SDC. The delivery terms for SDC will in any case be automatically extended by the duration of the period that the customer itself is in default to perform any obligation, without SDC having to first notify the customer and / or by the duration of the period. in which SDC was confronted with force majeure.

§ 3. Delivery takes place at the address indicated by the customer upon confirmation of the order.

All deliveries are performed by international transport as standard.

When submitting the order, we ask to provide a responsible person on delivery who can receive the goods.

SDC cannot be held responsible for the delivery schedules of the carrier and any delays and cannot accept compensation on this matter. All orders are delivered to the first gate on the ground floor of the customer's building. Exceptions to this rule must be confirmed by written agreement.

It is recommended to provide delivery to a warehouse that can receive the goods in good conditions.

Additional costs may apply to all deliveries with a truck with tail lift.

§ 4. The goods will be checked by the customer immediately upon delivery for their conformity and for any visible defects. If the customer sees visible defects on delivery, he must explicitly state these on the CMR. If the customer does not do this, SDC has the right to decline full responsibility for all damage.

§ 5. Counting from the moment that the customer is in default of collecting / receiving the goods, further storage of goods takes place at the expense and risk of the customer and against payment of a fee per day depending on the place in which these goods are stored. take over the SDC warehouses.

§ 6. In any case, the customer is responsible for loading, stacking and securing the goods on his vehicle.

## Artikel 5 Transfer of ownership - retention.

SDC retains exclusive ownership of all goods it supplies until all amounts due under the delivery, including any lump sum compensation, default interest and costs due in the event of late payment, have been paid in full.

The customer can therefore in no way dispose of the goods that are still owned by SDC in application of the previous paragraph. More specifically, he may not transfer them to third parties or object them with any certainty. Nor may he process, process, consume, incorporate them into other goods or mix them with other goods.

## Artikel 6 Risk transfer.

The risk with regard to the goods is transferred to the customer when the goods are ready for collection or shipment to the customer in SDC's warehouses, regardless of whether they have already become the property of the customer.

The shipment of goods is always at the risk of the customer, regardless of who is responsible for the shipping costs.

## Artikel 7 Billing and Payment.

§ 1. Unless otherwise agreed in writing or otherwise stated on SDC's invoices, SDC's invoices are payable in cash.

§ 2. The amount of SDC's invoices must be paid net without discount. Eventual (bank) costs are charged to the customer.

§ 3. If an invoice is incorrect, it must be protested with a registered letter within 15 days of the invoice date. Invoices that have not been protested within the aforementioned period and in the aforementioned manner will automatically be considered accepted.

§ 4. The place of payment of the customer's debts to SDC is at the registered office of SDC.

§ 5. The customer cannot refuse to pay for the goods already delivered by SDC because the totality of SDC's commitments has not (yet) been executed. Nor can the customer refuse to pay for delivered goods if he considers that the goods are non-compliant and / or defective and SDC has not acknowledged this.

§ 6. SDC has the right to first allocate payments to any costs owed, the conventional lump sum compensation and all overdue default interest before allocating it to the outstanding principal (s).

§ 7. If reasonable doubt can arise about the solvency of the customer - such as if the customer requests deferment of payment from a creditor, the customer does not pay one or more invoices from a creditor (in time), an attachment has been made at the expense of the customer, for the customer insolvency proceedings have been filed or opened (judicial reorganization, bankruptcy, collective debt settlement or similar proceedings), the customer is involved in a restructuring (merger, division, contribution from a universality or industry), the customer is dissolved and liquidated - SDC has the right to demand an advance or full advance payment for the commitments still to be performed, or to demand the provision of (additional) securities.

§ 8. SDC always has the right (also in the case of overlapping of creditors) to offset all amounts that SDC would owe the customer for whatever reason with the amounts owed by the customer to SDC, regardless of whether or not these amounts are already due and payable.

§ 9. For new customers (customers who order a 1st time) a 100% advance payment is requested from the invoice. The order will only be prepared after receipt of this payment. So only from the moment of payment also the delivery period starts to run. Afterwards, the customer can receive a payment term of 30 days after the invoice date, if they have an approved credit.

§ 10. The following conditions always apply to custom orders:

50% with order confirmation (only after receipt of payment, the production period starts to run)

40% before shipment of the goods (if the customer has an approved credit)

10% in 30 days (if the customer has an approved credit)

If the customer does not have an approved credit, he must pay the remaining 50% before shipping the goods.

## Artikel 8 Breach of contract

§ 1. In the absence of payment within the due date of one or more invoices, SDC has by operation of law and without notice of default

- right to the payment of default interest at a conventional interest rate equal to the interest rate referred to in Article 5 of the Law of 2 August 2002 on combating late payment in commercial transactions from the invoice date, as well as

- (b) right to payment of a flat-rate compensation of 10% of the amount not paid (on time), with a minimum of EUR 75, - and this without prejudice to SDC's right to compensation of the legal costs (including court fees) in the event of a judicial recovery procedure. must be fed.

§ 2. In the absence of payment on the due date of one or more invoices (drawn up in the context of the same or a different agreement), all outstanding but not yet due invoices that SDC issued to the customer will be due and payable by operation of law and without notice. due in § 1.

§ 3. In the absence of payment on the due date of one or more invoices (drawn up under the same or a different agreement), SDC has the right to suspend commitments that still have to be performed until it has received full payment.

§ 4. SDC has the right to dissolve the agreement without judicial intervention, with immediate effect, in whole or in part (i.e. for the part still to be executed) without being liable for any compensation, provided that it sends a registered letter informing this decision.

- in case of inability to issue one or more checks without cover due to protest of one or more bills due to seizure of charges, dissolution and liquidation of a collective debt settlement or bankruptcy of the customer

- (b) in case the customer fails to fulfill one or more of his obligations towards SDC, including the timely payment of the invoices drawn up by SDC or the requested advances or advance payments and the provision of (additional) securities, and this was not met within 15 days following a notice of default by SDC

- (c) in case the customer indicates that he will not fulfill his obligations.

In the event of dissolution, SDC is entitled to additional compensation at a flat rate of 50% of the amount SDC would have been entitled to if the agreement had been properly executed. In the



event of dissolution, the goods already delivered must be returned to SDC at the customer's expense, plus compensation for the depreciation that it may have undergone for whatever reason. In the event of partial termination, the part of the agreement executed by SDC must be paid in full by the customer and the additional compensation will be calculated on the part of the agreement that has not yet been executed.

#### **Artikel 9 Liability.**

§ 1. SDC will only be liable for damage caused by the non-execution, the incomplete execution, the late execution or the improper execution of its obligations in the event of its intentional or gross error. SDC is not responsible for any errors - including intentional and gross errors - committed by its employees and executive agents. SDC's liability is limited to compensation of foreseeable, direct and personal damage to the customer, to the exclusion of all indirect or intangible damage, including, without limitation, loss of profit, loss of customers or contracts and additional costs.

Any compensation payable by SDC will be limited to a maximum of the amount that SDC has invoiced to the customer or that it may have contractually invoiced for the goods that gave rise to the customer's damage. The customer expressly and unconditionally waives any further claims for damages of any kind at SDC's expense.

§ 2. If the goods are found to be non-compliant or if visible defects are found, the customer must immediately inform SDC and confirm his detailed complaints / findings in a registered letter to SDC within 48 hours after delivery, failing which the customer will not take any will be entitled to more repair, replacement or compensation. A legal claim must be instituted, under penalty of forfeiture, within 2 months after the establishment of the non-conformity / defect. The limitations of liability stated in §1 further apply.

§ 3. If hidden defects are discovered, the customer must immediately inform SDC and confirm his detailed complaints / findings within 48 hours after the defects have been identified by registered letter to SDC, failing which the customer will not be entitled to any repair, make more replacement or compensation. A legal claim must be instituted, under penalty of forfeiture, within 2 months after the establishment of the non-conformity / defect. The limitations of liability stated in §1 further apply.

§ 4. Unless the customer has informed SDC in writing, SDC is assumed to have no knowledge of the concrete use that the customer will make of its goods. The customer must check whether the technical properties of the goods are adequate for the use he wants to make of them.

§ 5. SDC is not liable for the result of operations that the customer performs or has performed on the goods.

§ 6. SDC is not liable for damage that has arisen after the goods have been changed by the customer or by a third party (through processing, processing, incorporation, mixing or otherwise).

§ 7. The information contained on the SDC website ([www.sdclab.be](http://www.sdclab.be)) is for information only. No rights can be derived from this information in any way, nor can this information give rise to any claims or (legal) claims.

§ 8. If SDC is liable (especially for non-conforming and / or defective goods), the customer must always give SDC the opportunity and allow a reasonable time to repair or replace the (non-conforming or defective) goods, before he can rely on any other remedy.

§ 9. The limitations of liability provided for in this article will always be interpreted in the sense that they have been legally interpreted. In the event that a limitation of liability provided in this article for certain hypotheses is not legally valid, such hypothesis will be deemed not to be intended / unwritten.

#### **Artikel 10 Privacy**

SDC makes every effort to comply with the obligations under the General Data Protection Regulation (GDPR). Any personal data is collected and kept by SDC for the following purposes:

- to be able to follow up on your order and / or questions about our goods
- to optimize cooperation with the customer;
- to be able to inform the customer about SDC goods and / or changes in the range
- to comply with any legal obligations incumbent on SDC;
- for handling financial transactions under the agreement with the customer;
- for sending our newsletters and (eventual) advertising messages in our sector.

For more information about the processing of personal data, SDC would like to refer to its privacy policy as shown on its website [www.sdclab.be](http://www.sdclab.be)

The customer can request to change, delete or transfer his data at any time by email to [info@sdclab.be](mailto:info@sdclab.be)

If the customer does not agree with the way in which his data is processed, he can contact the Commission for the protection of privacy (Drukpersstraat 35, 1000 Brussels, +32 (0) 2 274 48 00, [commission@privacycommission.be](mailto:commission@privacycommission.be)).

#### **Artikel 11 Force of the majority**

In the event that SDC is confronted with a force majeure situation, the performance of its obligations will be automatically suspended as long as that force majeure situation continues. If that situation of force majeure lasts longer than 2 months, SDC can declare the agreement dissolved, in which case it will be released from all its obligations. The customer is not entitled to compensation or reimbursement of amounts already paid if SDC is faced with a situation of force majeure.

Force majeure for SDC includes all circumstances that are not due to an error on the part of SDC and that make it impossible to implement SDC's commitments, seriously complicates them, seriously delays them or makes them at least 5% more expensive, including but not limited to fire, machine breakdown, accidents, strikes or lockouts, exceptional traffic disruptions, exceptional weather such as storm, snow and floods, import or export restrictions, tax increases, taxes, fees, charges, duties and customs or other government measures, exchange rate fluctuation, inflation, epidemic, riot or war, errors, delays, price increases or force majeure in suppliers of goods or services. The unacceptable and unavoidable nature of the aforementioned circumstances is always deemed to have been acquired.

#### **Artikel 12 Extensive right of retention.**

SDC is allowed to withhold all of the customer's property that it owns / detains (on its premises, in its warehouses and workshops, in its vehicles ...) until the customer owes all its debts to SDC (principal, interest, compensation, costs, ...) for whatever reason (including other agreements) has paid.

#### **Article 13 Warranty.**

##### **2-YEAR LIMITED WARRANTY**

Unless otherwise agreed at the time of the order, we offer a warranty for our products for 2 years after their shipment. This warranty applies to defects in design and material, provided that the product is used in the correct conditions and that it is used as intended. For example: - chairs are not expected to be used for more than 40 hours per week - all products using QM FOAM are only intended for sitting and / or sleeping. The guarantee therefore does not apply to jumping, standing or walking on the furniture. The usual wear and tear of the products is also expressly excluded from the warranty. After a while, the products for which QM FOAM was used will show an "oxidation layer" and a certain "texture". This was deliberately chosen as part of the design and can in no way be considered damage. During the life of the product, SDC offers the buyer after-sales services. Products made of veneer and laminate are not covered by the warranty, but SDC will pass on to the purchaser any warranty that SDC itself has received from manufacturers of veneer and laminate products.

Damage caused by water, ultraviolet light, sea or extreme temperature changes is expressly excluded from the warranty. SDC makes no other warranty for products or their suitability for any other purpose, as well as no other express or implied warranty. Products that do not meet the description, are defective in any area or that are defective in terms of execution or material will be replaced, repaired or, if SDC so decides, credit will be given to the buyer at the value of the original purchase price, provided that SDC is notified of such defect within seven (7) days of delivery and that the purchaser returns the product according to SDC's instructions. The aforementioned represents the sole remedy for the purchaser and SDC's sole obligation with regard to delivered products. The buyer agrees to waive any and all rights or claims against SDC in accordance with law and fairness. SDC is not liable for direct, indirect, incidental, special or resulting damage under any circumstances, including damage or loss resulting from inability to use the products, increased operating costs or production loss, or any other form of damage results from reasons similar to the above or not (this list is not exhaustive). This warranty gives you specific legal protection, which may vary from state to state or country to country. Some states do not allow limitations on how long an implied warranty lasts, so the above limitations may not apply to you.

#### **Artikel 14 Designs**

All designs shown in our catalog and associated prices are and remain our property. All dimensions shown are only an indication. SDC's catalog and price list are not available to the general public and are only released commercially to encourage purchase.

#### **Artikel 15 Material**

SDC carefully selects only the finest, best quality material for its products. Although SDC makes every effort to ensure a consistent appearance of the products, all products sold are subject to commercially acceptable variations or inequalities in color, surface, texture or texture. These deviations are due to the nature of the materials and the techniques used. Since wood is a natural raw material, its color changes over time. This is due to the influence of sunlight, but is also due to the aging of the wood itself. Differences in color can therefore also differ from load to load. Since our tables and chairs come from different production loads, slight differences in color and texture are possible.

#### **C.O.M./UPHOLSTERY**

C.O.M.stuffs should be sent to SDC completely free of charge. The fabric requirements are indicated by SDC and always refer to uniform, solid colored fabrics, with a width of 140 cm. Unless expressly agreed in advance, SDC will refuse fabrics with a pattern. Stripes and lines are also considered patterns in the areas of cutting and knitting, and must therefore be announced in advance. For leather orders, we use a minimum order quantity per color. Several production loads of fabrics and leather may differ slightly in terms of hue. This means that SDC checks the substances against grayscale ((UNI EN 20105 A02 / A03) but cannot be held responsible for unavoidable persistent minor differences.

#### **Artikel 16 Varia.**

If it has been agreed that goods will be delivered on demand, all goods that have not yet been called up will be invoiced by SDC at the end of the call-off period.

#### **Artikel 17 Divisibility of the clauses.**

Any total or partial invalidity, nullity, unenforceability or unenforceability of one or more clauses of these general terms and conditions does not affect the validity, enforceability and enforceability of the other clauses or the other part. The parties undertake to replace the clause in question with a valid, enforceable and enforceable clause that is as close as possible to the original intention of the parties.

#### **Artikel 18 Applicable law and competent court.**

§1. The legal relationships between the parties are exclusively governed by Belgian law.

§2. (a) In the event of a dispute, the courts of the district where SDC has its registered office shall have exclusive jurisdiction according to their respective substantive jurisdiction.

(b) In addition, only SDC also has the right to bring the dispute to the (domestic or foreign) court that would have jurisdiction if the jurisdiction clause of §2 (a) were not included in these general terms and conditions.